

ideal lux |19





















**ideal lux<sup>®</sup>**



# Indice generale

		Indice alfabetico	004	
		Indice tipologie	008	
Moderno		Coordinati e sospensioni	046	
		Parete e soffitto	268	
		Tavolo e terra	354	
Classico		Coordinati e sospensioni	398	
		Parete e soffitto	632	
		Tavolo e terra	664	
Tecnico		Profili e tracklights	698	
		Faretti da incasso	766	
		Parete e soffitto	806	
		Sospensioni	852	
Esterno		Tavolo e terra	868	
		Parete e soffitto	934	
		Incasso	976	
		Lampadine e accessori	986	
				
		Indice per codice	1006	

# Indice alfabetico

Abc	404	Audi-80	090	Bright	837	Clip	294	DiscoveryCromo	160
Abram	945	Audi-B	311	Brigitta	478	Clown	080	DiscoveryFade	158
Accademy	563	Augustus	524	Brooklyn	442	Club	867	Dna	414
Acqua	913	Aurora	102	Bubble	937	Cocktail	174	Doc	439
Admiral	112	Avion	267	Ca' D'Oro	505	Cognac	168	Doge	482
Air	378	Baco	078	Ca' Foscari	504	Colonna	360	Dolomiti	694
Aladino	186	Bar	142	Caesar	522	Colossal	466	Domus	568
Alba	544	Barber	647	Cairo	202	Cometa	966	Don	191
Alexander	507	Barby	048	Calypso	122	Comfort	064	Dony	306
Alfa	346	Baronet	474	Camelia	494	Commodore	282	Dora	603
Alfa	660	Base	948	Camerino	315	Compo	194	Doris	872
Alfiere	677	Basic	788	Camilla	608	Concerto	888	Dorothy	685
Ali	312	Basket	232	Canaletto	512	Concorde	228	Dorsale	356
Almond	292	Beethoven	472	Canapa	585	Cono	144	Double	327
Alpen	441	Berta	973	Candy	212	Continental	492	Down	974
Amaca	572	Beverly	680	Cantina	443	Copernico	400	Draft	736
Amadeus	509	Bijoux	635	Carlton	543	Corallo	072	Dream Big	264
Amelia	900	Bill	833	Carmen	642	Corda	584	Driftwood	596
Ampolla	436	Bin	666	Carrara	641	Corte	611	Drill	678
Amsterdam	696	Birillo	390	Casanova	468	Cortina	615	Dubai	520
Andromeda	960	Birillo Outdoor	878	Cascina	610	Cosmo	062	Duca	569
Anello	291	Bistrò	416	Ceci	981	Cover	834	Duchessa	689
Anfora	629	Biva-50	695	Cecilia	982	Croisette	224	Dust	075
Anna	896	Blanche	558	Celine	309	Cross	274	Dynamic	774
Ape	639	Blob	420	Cesto	426	Cube	836	Dynamo	335
Apollo	951	Blues	805	Chalet	594	Cupcake	391	Dynamo	649
Arca	700	Boa	215	Champagne	609	Cylinder	192	Ecoflex	266
Arco	326	Bob Mini	656	Channel	808	Daddy	358	Edelweiss	448
Arco	648	Bollicine	086	Ciak	344	Danieli	480	Edgar	826
Aria	184	Bon Bon	496	Cico	326	Dea	076	Edison	135
Arizona	208	Bonjour	320	Cico	649	Deca	621	Edith	598
Armony	884	Book	338	Cima	894	Deda	451	Edo	393
Artù	614	Bossanova	662	Cin Cin	222	Delta	796	Edo Outdoor	916
Astrid	646	Bow	322	Circus	260	Denis	312	Effetti	240
Astro	943	Bow	650	Citrus	428	Desiree	397	Ekos	241
Audi-10	148	Box	291	Clarissa	434	Desk AP	839	Electric	429
Audi-20	149	Brandy	613	Classic Globe	892	Desk SP	866	Elegant	547
Audi-61	124	Breeze	456	Click	840	Diamond	200	Elica	179
Audi-77	531	Brick	846	Clio	936	Disco	066	Elis	350

Elisa	924	Foglio	848	Harem	588	Kraken	671	Lunare	342
Elisir	540	Foil	244	Haunt	580	Kronplatz	574	Luxor	526
Elvis	676	Folk	461	Hellen	329	Krypton	932	Luxury	234
Elysee	092	Forcola	684	Hilton	254	Kuky	145	Madame	230
Eminent	370	Francy	963	Hole	921	Kyoto	630	Maddi	971
Emis	223	Frida	438	Holiday	278	Lab	950	Magic	686
Entry	628	Fungo	395	Hot	841	Lana	182	Maglie	631
Equinoxe	402	Funky	804	Hotel	279	Lawyer	697	Majestic	546
Esil	304	Futura	372	Hugo	134	Le Roy	556	Mallow	058
Etere	914	Game	782	Hydro	844	Leaves	070	Mama	185
Eternity	691	Garage AP	830	Igor	422	Lena	180	Mandarin	453
Etna	190	Garage PL	820	Iguazù	121	Leti	980	Manhattan	175
Eva	188	Garage SP	864	Ikes	303	Liberty	536	Mapa Bianco	218
Evasione	530	Gas	910	Iko	942	Lido	170	Mapa Fade	156
Event	566	Geko	285	Impero	533	Lika	768	Mapa Max	151
Evolution	298	Germana	968	Inside	931	Lilly	500	Mapa Riga	216
Eye	798	Giada Clear	098	Iris	308	Lilly Table	690	Mapa Sat	150
Fiesta	890	Giada Color	100	Isa	256	Limbo	644	Maracas	658
Fiocco	638	Giglio	600	It	134	Line	317	Marrakech	591
Fiordi	463	Gim	328	Itaca	870	Lingotto	430	Marte	920
Fiore	634	Gin	850	Jar	880	Link	752	Martinez	542
Firenze	602	Gingle	284	Jazz	804	Live	882	Matt	847
Fish	050	Gioconda	534	Justine	607	Logos	301	Maurien	673
Fisherman	460	Giove	962	K2	396	Loko	415	Maximilian	498
Fit	382	Giudecca	488	Karma	196	Lola	835	Mercurio	922
Fix	282	Glim	818	Karousel	054	London	362	Mermaid	674
Flam	146	Glory	206	Kate	687	LondonCromo	238	Metro	457
Flap	831	Gocce	120	Kelly	376	Look	138	Mib	967
Flash	297	Goose	332	Ken	149	Lounge	804	Mikado	275
Flash Gesso	849	Green	893	Keope	944	Lucciola	327	Mike	972
Flat	305	Gretel	419	Kepler	410	Lucciola	648	Milk	178
Flex	334	Groove	794	King	106	Luce Bianco	153	Millennium	582
Florian	516	Gru	379	Kiss	409	Luce Cromo	152	Minimal	132
Flower	266	Gun	946	Klaus	440	Luce Max	154	Minitommy	929
Fluo	726	Halo PL	814	Klimt	385	Lucia	970	Miramare	490
Flut	177	Halo SP	856	Konse	065	Lugano	449	Mirror-10	324
Focus-1	330	Hammam	586	Kool AP	845	Lulù	314	Mirror-10	653
Focus-2	331	Hangar	454	Kool SP	863	Lumina	296	Mirror-20	325
Foglia	618	Hansel	418	Kool Table	389	Luna	876	Mirror-20	654

# Indice alfabetico

Mirror-51	325	Olimpia	176	Pisa	604	Rocket Mini	984	Snif Square	957
Missouri	243	OmegaRound	941	Plumber	424	Roma	104	Snoopy	899
Mito	300	OmegaSquare	953	Polaris	912	Romantik	532	Soda	851
Moby	458	Onion	435	Polka	662	Rondo	620	Soffio	352
Monet	581	Opera	548	Polly	374	Rose	486	Soft	172
Mood	812	Oracle	854	Polo PL	816	Royal	118	Sole	874
Moonlight	116	Orangerie	625	Polo SP	858	Rubens	276	Soul	663
Moris	293	Orbital	063	Pon Pon	272	Rubik	955	Sound	886
Mouse AP	842	Origami	198	Pop	052	Ruby	421	Space	068
Mouse PL	822	Orion	108	Posta	287	Rustik	420	Spiga	606
Movie	366	Orson	335	Potty	626	Sailor	462	Spirit	111
Mozart	634	Ovalino	201	Praga	510	Sally	377	Spot AP	843
Mr Jack	136	Oxy	714	Prato	394	Saloon	427	Spot PL	823
Multiflex	262	Pacific	227	Privè	318	SambaRound	800	Stadium	857
Napoleon	514	Page	333	Provence	578	SambaSquare	802	Stage	364
Nastrino	242	Pagoda	368	Pulsar	908	Santa	470	Stand Up	381
Navy	455	Palio	605	Puzzle	290	Sasso	879	Stella	624
Nawa	590	Palladio	214	Quadro	114	Save	306	Steno	302
Negresco	484	Palmares	513	Quasar	087	Scacchi	640	Step	682
Nemo	163	Pan	408	Queen	554	Sem	612	Stones	640
Nemo Clear	162	Pandora	137	Quick	738	Senix	570	Strale	334
Neos	907	Pantheon	564	Radetzky	502	Sesto	203	Strauss	476
Neve	088	Paper	592	Radio	130	Shell	637	Studio	392
Newton	446	Paris	550	Rain Clear	094	Sheraton	258	Style	902
Nina	975	Park	978	Rain Color	096	Shots	229	Sugar	147
Nitro	810	Park Led	979	Read	339	Shower	645	Sunglasses	940
Nodi Bianco	084	Pashà	528	Redentore	464	Sign	832	Sunrise	277
Nodi Cromo	082	Paul	290	Reflector	668	Simply	309	Superior	226
Nodi Crystal	271	Pauline	073	Regol	380	Sirio	918	Swan	552
Nodino	270	Pavone	593	Renoir	503	Sky	140	Swing	804
Nordik	248	Pearl	518	Retrò	652	Slem	348	Tall	126
Norma	622	Pegaso	560	Rex-1	964	Slot	758	Tea	286
Nostalgia	351	Penombra	220	Rex-2	965	SmartiesBianco	204	Tek	310
Oak PL	821	Peter	576	Rex-3	965	SmartiesClear	164	Tender	273
Oak SP	862	Phoenix	236	Rialto	506	Smile	744	Terra	926
Oby	340	Piano	371	Riflesso	828	Smug	242	Terry	501
Ocean	304	Picchio	336	Ring	307	Snake	353	Tesla	898
Octopus	056	Pila	314	Ritz	250	Snell	692	Tetris-1	958
Oil	128	Pipeline	938	Rocket	985	Snif Round	949	Tetris-2	959

Tiepolo	508	Vanity	538
Tintoretto	636	Vega	923
Tirol	616	Vela	283
Titano	919	Venus	909
Titti	265	Versus	060
Tiziano	636	Violette	562
Tnt	440	Virgin	110
Toffee	308	Voga	688
Tokyo	093	Volt	432
Tolomeo	189	Volterra	599
Tommy	928	Vortex	074
Tonic	851	Wally	377
Torchio	670	Wave	143
Toronto	069	Wheel	252
Torre	906	Whisky	850
Totem	299	White Lady	499
Touch	388	Windsor	511
Tower	824	Winery	643
Toy Linear	316	Woody	246
Triade	450	World	412
Tridente	384	Xeno	939
Triplo	310	Yoga	166
Triumph	406	York	386
Tronco	904	Zed	288
Truman	672	Zenith	930
Tube	861	Zeno	167
Tudor	313	Zephyr	799
Tuly	452	Zeus	952
Twin	956	Zig Zag	838
Ufo PL	817		
Ufo SP	859		
Ulisse	210		
Ultrathin	860		
Union	280		
Universal	281		
Up	954		
Up And Down	444		
Urano	969		
Valentina	617		



Quick

Pag 742



# Lampade a sospensione



Barby 048

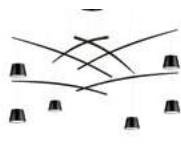

Fish 050



Pop 052



Karousel 054



Versus 060



Cosmo 062



Orbital 063



Leaves 070



Corallo 072



Pauline 073



Vortex 074



Dust 075



Dea 076



Disco 066



Baco 078



Clown 080



Bollicine 086



Quasar 087



Audi-80 090



Elysee 092



Tokyo 093



Rain Clear 094



Giada Clear 098



Aurora 102



Admiral 112

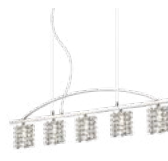

Spirit 111



Rain Color 096



Giada Color 100



Roma 104



King 106



Orion 108



Virgin 110



Calypso 122



Audi-61 124



Oil 128



Radio 130



Minimal 132



Hugo 134



It 134



Edison 135



Mr Jack 136



Look 138



Sky 140



Bar 142



Kuky 145



Flam 146



Cono 144



Cognac 168



Audi-10 148



Audi-20 149



Ken 149



Mapa Sat 150



Mapa Max 151



Luce Cromo 152



Luce Bianco 153





Space 068



Toronto 069



Comfort 064



Konse 065



Nodi Cromo 082



Nodi Bianco 084



Gocce 120



Iguazù 121



Tall 126



Pandora 137



Luce Max 154



# Nodi Cromo

Pag. 082



# Lampade a sospensione



Cin Cin 222



Emis 223



Mapa Fade 156



Discovery Fade 158



DiscoveryCromo 160



Nemo Clear 162



Nemo 163



Yoga 166



Sugar 147



Soft 172



Wave 143



Lido 170



Cocktail 174



Manhattan 175



Lena 180



Lana 182



Aria 184



Mama 185



Eva 188



Tolomeo 189



Etna 190



Diamond 200



Ovalino 201



Cairo 202



Sesto 203



SmartiesBianco 204



Glory 206



Arizona 208



Quadro 114



Croisette 224



Concorde 228



Shots 229



Superior 226



Madame 230



Ekos 241



Missouri 243



Smug 242



Nastrino 242



Luxury 234



Phoenix 236



Basket 232



Effetti 240



LondonCromo 238



Nordik 248



Foil 244



Woody 246



Hilton 254



Multiflex 262



Dream Big 264



Avion-1 267



Avion-2 267



SmartiesClear 164



Zeno 167



Olimpia 176



Flut 177



Milk 178



Elica 179



Don 191



Cylinder 192



Aladino 186



Karma 196



Origami 198



Compo 194



Ulisse 210



Candy 212



Palladio 214



Boa 215



Mapa Riga 216



Mapa Bianco 218



Penombra 220



Isa 256



Wheel 252



Sheraton 258

# Lampade da soffitto



Movie 366



Phoenix 236



Woody 246



Ritz 250



Wheel 252



Leaves 070



Corallo 072



Pauline 073



Vortex 074



Dea 076



Nodi Cromo 082



Nodi Bianco 084



Neve 088



Moonlight 116



Royal 118



Rain Clear 094



Giada Clear 098



Rain Color 096



Giada Color 100



Smarties Clear 164



Smarties Bianco 204



Lana 182



Ring 307



Candy 212



Mapa Bianco 218



Glory 206



Dony 306



Save 306



Toffee 308



Simply 309



Logos 301



Ali 312



Superior 226



Pacific 227



Union 280



Flat 305



Celine 309



Iris 308



Lunare 342



Ciak 344



Nostalgia 351



Alfa 346



Slem 348



Soffio 352



Snake 353



Octopus 056



Multiflex 262



Ecoflex 266



Tender 273



Titti 265



Flower 266



Pon Pon 272



Nodino 270



Nodi Crystal 271



Cross 274



Mikado 275



Admiral 112



Quadro 114



Roma 104



King 106



Virgin 110



Orion 108



Calypso 122



Audi-61 124



Ulisse 210



Arizona 208



Compo 194



Almond 292



Ovalino 201



Geko 285



Evolution 298



Ocean 304



Esil 304



Steno 302



Ikes 303



Mito 300



Totem 299



Elis 350



Oby 340



Mallow 058

# Lampade da parete



Barby 048



Corallo 072



Nodi Cromo 082



Nodi Bianco 084



Circus 260



Octopus 056



Multiflex 262



Versus 060



Neve 088



Moonlight 116



Royal 118



Aurora 102



Rain Clear 094



Giada Clear 098



Rubens 276



Orion 108



Roma 104



Calypso 122



Audi-61 124



Quasar 087



Anello 291



Radio 130



Minimal 132



Edison 135



Picchio 336



Tender 273



Triplo 310



Audi-B 311



Elica 179



Smarties Clear 164



Smarties Bianco 204



Lana 182



Ovalino 201



Mapa Riga 216



Mapa Bianco 218



Union 280



Universal 281



Commodore 282



Fix 282



Vela 283



Mito 300



Tea 286



Zed 288



Logos 301



Box 291



Moris 293



Tek 310



Ali 312



Denis 312



Pila 314



Lulù 314





Titti 265



Flower 266



Giada Color 100



Spirit 111



Admiral 112



Quadro 114



Mapa Fade 156



Discovery Fade 158



Discovery Cromo 160



Penombra 220



Sunrise 277



Gingle 284



Camerino 315



Line 317



# Gingle

Pag 284

# Lampade da parete



Sky 140



Paul 290



Puzzle 290



Tudor 313



Posta 287



Clip 294



Flash 297



Lumina 296



Privè 318



Toy Linear 316



Gim 328



Hellen 329



Book 338



Read 339



Focus-1 330



Focus-2 331



Goose 332



Page 333



Strale 334



Flex 334



Orson 335



Bonjour 320



Bow 322



Mirror-10 324



Mirror-20 325



Mirror-51 325



Arco 326



Cico 326



Oby 340



Lunare 342



Ciak 344



Alfa 346



Slem 348



Elis 350



Nostalgia 351



Basket 232



Nastrino 242



Woody 246



Hilton 254



Isa 256



Luxury 234



Phoenix 236



Sheraton 258



Hotel 279



Holiday 278



Effetti 240



Nordik 248





Dynamo 335



Double 327



Lucciola 327



Soffio 352



Snake 353



# Focus-2

Pag 331



# Lampade da tavolo e terra



Stage 364



Movie 366



Piano 371



Pagoda 368



Daddy 358



Dorsale 356



Minimal 132



DiscoveryCromo 160



Stand Up 381



Colonna 360



Sesto 203



Cylinder 192



Phoenix 236



Rain Clear 094



Radio 130



Mallow 058



Elica 179



Basket 232



Effetti 240



Woody 246



London Cromo 238



London 362



Nordik 248



Regol 380



Fit 382



Tridente 384



York 386



Eminent 370



Polly 374



Futura 372



Hilton 254



Isa 256



Sheraton 258



Luxury 234



Klimt 385

# Fit

Pag 382





# Lampade da tavolo e terra



Kelly 376



Wally 377



Sally 377



Neve 088



Moonlight 116



Royal 118



Rain Color 096



Roma 104



Admiral 112



Quadro 114



Mapa Max 151



Luce Max 154



Mapa Fade 156



Touch 388



Aladino 186



Prato 394



Fungo 395



K2 396



Desiree 397



Diamond 200



Smarties Bianco 204



Candy 212



Mapa Riga 216



Mapa Bianco 218



Penombra 220



Edo 393



Air 378



Gru 379



Studio 392



Kool Table 389



Orion 108



Emis 223



Birillo 390



Cupcake 391



**Air**

Pag 378



# Lampade a sospensione



Copernico 400



Equinoxe 402



Kepler 410



Dna 414



Loko 415



World 412



Pan 408



Lingotto 430



Igor 422



Plumber 424



Electric 429



Saloon 427



Cesto 426



Tnt 440



Blob 420



Bistrò 416



Ruby 421



Gretel 419



Hansel 418



Rustik 420



Alpen 441



Hangar 454



Breeze 456



Metro 457



Triade 450



Fiordi 463



Newton 446



Deda 451



Navy 455



Moby 458



Fisherman 460



Sailor 462



Folk 461



Cantina 443



Colossal 466



Santa 470



Beethoven 472



Negresco 484



Continental 492



Tiepolo 508



Redentore 464



Casanova 468



Danieli 480



Doge 482



Alexander 507



Impero 533



Gioconda 534



Liberty 536



Baronet 474



Strauss 476



Ca' Foscari 504



Ca' D'oro 505



Rialto 506



Brigitta 478



Rose 486





Kiss 409



Triumph 406



Up and Down 444



Brooklyn 442



Mandarin 453



Edelweiss 448



Lugano 449



Volt 432



Clarissa 434



Onion 435



Ampolla 436



Citrus 428



Abc 404



Doc 439



Frida 438



Klaus 440



Tuly 452



Amadeus 509



Giudecca 488



Canaletto 512



Napoleon 514



Florian 516



Vanity 538



Radetzky 502



Renoir 503



# Lampade a sospensione



Bon Bon 496



White Lady 499



Praga 510



Windsor 511



Maximilian 498



Miramare 490



Camelia 494



Terry 501



Blanche 558



Pegaso 560



Pantheon 564



Senix 570



Event 566



Domus 568



Dubai 520



Caesar 522



Augustus 524



Pearl 518



Luxor 526



Evasione 530



Alba 544



Opera 548



Swan 552



Paris 550



Queen 554



Le Roy 556



Kronplatz 574



Peter 576



Monet 581



Millennium 582



Amaca 572



Corda 584



Canapa 585



Paper 592



Haunt 580



Edith 598



Volterra 599



Pisa 604



Giglio 600



Firenze 602



Dora 603



Palio 605



Justine 607



Champagne 609



Cascina 610



Corte 611



Sem 612



Brandy 613



Rondo 620



Orangerie 625



Deca 621



Stella 624



Norma 622



Potty 626



Entry 628





Lilly 500



Palmares 513



Accademy 563



Romantik 532



Violette 562



Provence 578



Spiga 606



Duca 569



Audi-77 531



Pashà 528



Elisir 540



Martinez 542



Carlton 543



Elegant 547



Majestic 546



Harem 588



Hammam 586



Nawa 590



Marrakech 591



Driftwood 596



Chalet 594



Pavone 593



Cortina 615



Artù 614



Camilla 608



Tirol 616



Valentina 617



Foglia 618



Kyoto 630



Anfora 629



Maglie 631

# Lampade da soffitto



Triumph 406



Loko 415



Plumber 424



Lingotto 430



Winery 643



Pearl 518



Elisir 540



Dubai 520



Caesar 522



Augustus 524



Pashà 528



Mozart 634



Bijoux 635



Fiore 634



Alba 544



Majestic 546



Elegant 547



Carlton 543



Martinez 542



Pavone 593



Harem 588



Norma 622



Bob Mini 656



Maracas 658



Alfa 660



Foglia 618



Shell 637



Tintoretto 636



Tiziano 636



Tirol 616



Valentina 617



Polka 662



Soul-1 663



Soul-2 663



Bossanova 662



# Maracas

Pag 658

# Lampade da parete



Equinoxe 402



Kepler 410



Frida 438



Maracas 658



Winery 643



Triumph 406



Plumber 424



Pan 408



Volt 432



Igor 422



Tnt 440



Reflector 668



Newton 446



Limbo 644



Shower 645



Drill 678



Astrid 646



Brooklyn 442



Cantina 443



Sailor 462



Bob Mini 656



Barber 647



Alfa 660



Norma 622



Anfora 629



Harem 588



Hammam 586



Santa 470



Fiocco 638



Ape 639



Stones 640



Scacchi 640



Carrara 641



Foglia 618



Valentina 617



Tirol 616



Chalet 594



Volterra 599



Millennium 582



Carmen 642



Retrò 652



Arco 648



Cico 649



Lucciola 648



Bow 650



Mirror-10 653



Mirror-20 654

# Limbo

Pag 644



Dynamo 649



# Lampade da parete



Redentore 464



Beethoven 472



Negresco 484



Continental 492



Tiepolo 508



Amadeus 509



Colossal 466



Casanova 468



Danieli 480



Doge 482



Alexander 507



Canaletto 512



Miramare 490



Windsor 511



Napoleon 514



Floriano 516



Impero 533



Gioconda 534



Liberty 536



Vanity 538



Giglio 600



Firenze 602



Dora 603



Palio 605



Cortina 615



Artù 614



Justine 607



Event 566



Terry 501



Romantik 532



Blanche 558



Pegaso 560



Violette 562



Pantheon 564



Paris 550



Beverly 680



Peter 576



Kronplatz 574



Opera 548



Swan 552



Pearl 518



Dubai 520



Caesar 522



Augustus 524



Evasione 530



Elisir 540



Mozart 634



Alba 544



Carlton 543



Martinez 542



Elegant 547



Baronet 474



Strauss 476



Ca' D'oro 505



Rialto 506



Brigitta 478



Rose 486



Maximilian 498



White Lady 499



Bon Bon 496



Champagne 609



Cascina 610



Corte 611



Domus 568



Senix 570



Spiga 606



Pashà 528



# Lampade da tavolo e terra



Opera 548



Paris 550



Queen 554



Le Roy 556



Pegaso 560



Step 682



Accademy 563



Firenze 602



Dora 603



Kronplatz 574



Provence 578



Driftwood 596



Biva-50 695



Igor 422



Plumber 424



Bin 666



Newton 446



Reflector 668



Kraken 671



Torchio 670



Drill 678



Beverly 680



Amsterdam 696



Elvis 676



Florian 516





Senix 570



Forcola 684



Dorothy 685

# Maurien

Pag 673



Maurien 673





# Lampade da tavolo e terra



Magic 686



Kate 687



Voga 688



Duchessa 689



Lilly Table 690



Eternity 691



Pantheon 564



Snell 692



Peter 576



Chalet 594



Dolomiti 694



Igor 422



Volt 432



Mermaid 674



Maglie 630



Truman 672



Alfiere 677



Lawyer 697



Elisir 540



# Snell

Pag 692



# Profili e tracklights



Arca Track 702



Arca Accent 704



Arca Wide 706



Arca Pendant 708



Oxy Single 716



Oxy Double 718



Oxy Accent 720



Oxy Wide 720



Oxy Pendant 722



Fluo Accent 728



Fluo Wide 730



Fluo Bi-Emission 732



Draft 736



Quick 738



Smile 744



Link 752



Slot 760



Slot 760



Slot 760



Slot 762



Slot 762



# Faretti da incasso



Dynamic 774



Basic 788



Game 782



Groove 794



Samba 800



Delta 796



Swing 804



Dynamic 774



Lika 768



Game 782



Groove 794



Samba 802



Zephyr 799



Lounge 804

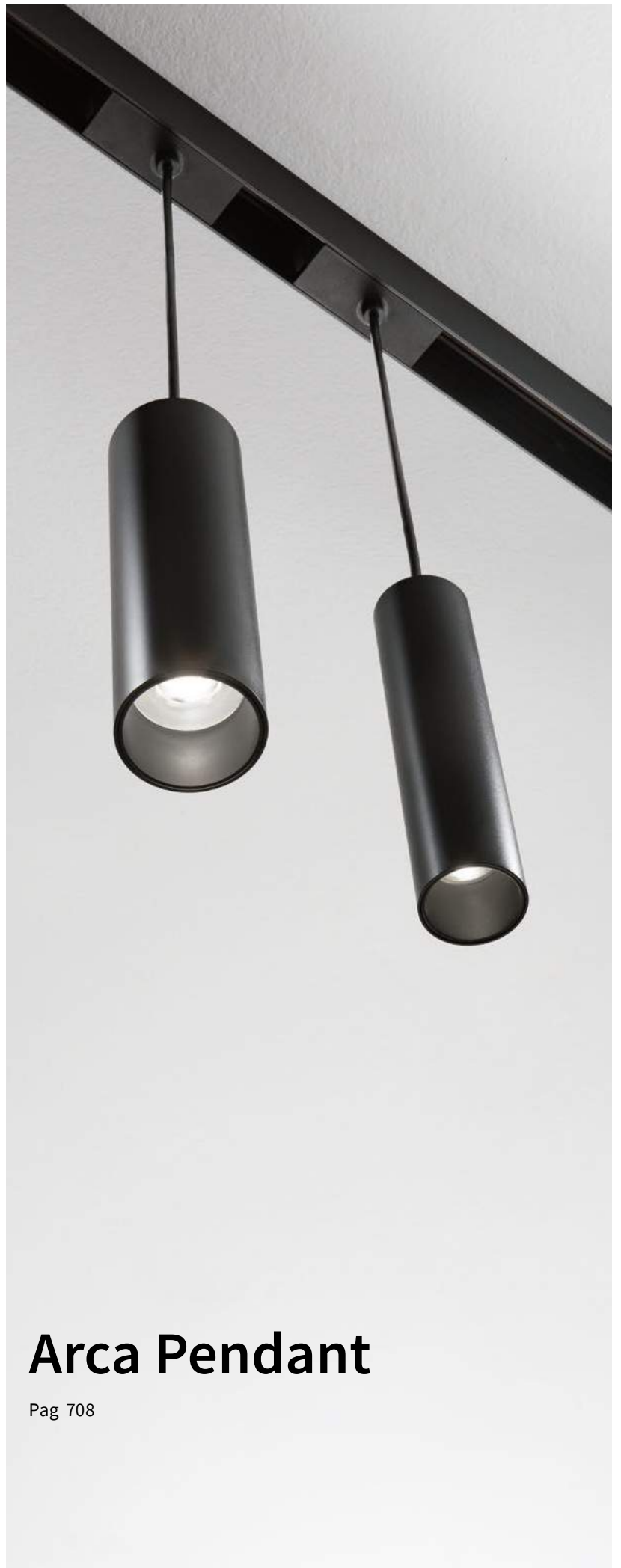

# Arca Pendant

Pag 708



Jazz 804



Blues 805



Funky 804



Eye 798

## Lampade da soffitto



Nitro 810



Mood 812



Oak 821



Tower 824



Garage 820



Halo 814



Polo 816

## Lampade da parete



Garage 830



Flap 831



Cover 834



Hot 841



Spot 843



Mouse 842



Sign 832



Bill 833



Brick 846



Matt 847



Click 840



Hydro 844



Kool 845



Lola 835



Edgar 826



Riflesso 828



Gin 850



Tonic 851



Whisky 850



Soda 851



Foglio 848

## Lampade a sospensione



Oracle 854



Halo 856



Stadium 857



Polo 858



Ufo 859



Garage 864



Garage 864



Ultrathin 860



Tube 861



Oak 862

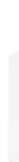

Oak 862



Kool 863



Desk 866



Club 867



Ufo 817



Channel 808



Glim 818



Mouse 822



Spot 823



Cube 836



Bright 837



Zig Zag 838



Desk 839



Flash Gesso 849

# Lampade da tavolo e terra



Doris 872



Sole 874



Luna 876



Sasso 879



Birillo Outdoor 878



Live 882



Live 882



Armony 884



Sound 886



Concerto 888



Classic Globe 892



Cima 894



Snoopy 899



Style 902



Neos 907



Tesla 898



Tronco 904



Torre 906



Acqua 913



Pulsar 908



Venus 909



Etere 914



Edo Outdoor 916



Edo Outdoor 916



Amelia 900



Elisa 924



Elisa 924



Terra 926



Minitommy 929



Tommy 928



Zenith 930



Inside 931



Krypton 932





Live 882



Live 882



Jar 880



Itaca 870



Polaris 912



Marte 920



Sirio 918



Mercurio 922



Vega 923



Titano 919



Hole 921



Zenith 930



Gas 910



Anna 896



Green 893

# Lampade da parete e soffitto



Armony 884



Sound 886



Concerto 888



Clio-1 936



Clio-2 936



Clio-3 936



Cima 894



Anna 896



Style 902



Amelia 900



Tronco 904



Marte 920



Elisa 924



Bubble 937



Etere 914



Terra 926



Minitommy 929



Tommy 928



Gas 910



Zenith 930



Xeno 939



Omega Round 941



Pipeline 938



Iko 942



Astro 943



Apollo 951



Keope 944



Zeus 952



Omega Square 953



Up 954



Rubik 955



Snif Square 957



Tetris-1 958



Tetris-2 959



Abram 945



Twin 956



Andromeda 960



Rex-1 964



Rex-2 965



Rex-3 965



Giove 962



Cometa 966



Germana 968



Lucia-1 970



Lucia-2 970



Maddi-1 971



Maddi-2 971



Mike 972



Luna 876



Sole 874



Sasso 879



Bubble 937



Armony 884



Sound 886



Concerto 888

# Mib

Pag 967



Gun 946



Base 948



Snif Round 949



Lab 950



Down 974



Francy-1 963



Francy-2 963



Nina 975



Berta 973



Mib 967



Mib 967



Sunglasses 940



Gun 946



Urano 969





# Lampade a sospensione



Armony 884



Sound 886



Concerto 888



Fiesta 890



Sole 874



# Lampade a incasso



Park Round 978



Park Square 978



Park Led 979



Leti Round 980



Leti Square 980



Ceci Round 981



Ceci Square 981



Cecilia 982



Rocket-1 985



Rocket-2 985



Rocket Mini 984



Rocket Mini 984



Rocket Mini 984



# Park Led

Pag 979



# Moderno Coordinati e sospensioni













# Barby

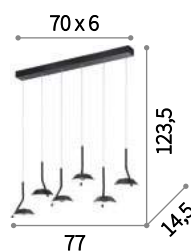

Base e montatura in metallo verniciato opaco. Schermo diffusore in materiale plastico opale. Led integrati.

**LED** Sorgente luminosa LED 4000 K, 20.000 h di durata.







 IP20  
 LED 30W / 1950 Lm  
 190778 SP6

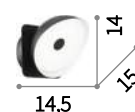



 IP20  
 LED 18W / 1170 Lm  
 190815 AP1 Medium





 IP20  
 LED 8W / 440 Lm  
 190808 AP1 Small





# Fish

Rosone, asta e diffusore in metallo verniciato opaco. Cavo in acciaio con supporto in metallo cromato. Led integrato con schermo opale.

**LED** Sorgente luminosa LED 3000 K, 20.000 h di durata.

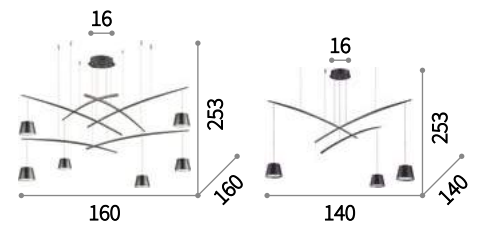

⊕ ⊖ IP20

LED 37W / 2800 Lm

196985 SP6 Bianco  
196992 SP6 Nero

⊕ ⊖ IP20

LED 18W / 1400 Lm

196961 SP3 Bianco  
196978 SP3 Nero





196992



# Pop

Rosone, montatura e copri portalampane in metallo rifinito con vernice opaca. Cavi regolabili in lunghezza.

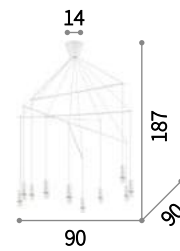

⊕ ⊖ IP20

E27 max 10 x 60W

186801 SP10 Bianco  
158860 SP10 Nero

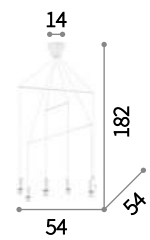

⊕ ⊖ IP20

E27 max 6 x 60W

186795 SP6 Bianco  
158815 SP6 Nero



158860







# Karousel

Montatura in metallo rifinito in ottone satinato. Diffusori in vetro incamiciato bianco, soffiato e acidato.

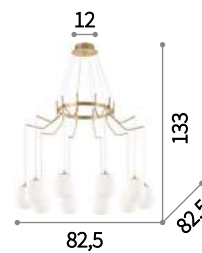



Lampadine LED G9 3,2W 3000 K incluse. Cod. 209043



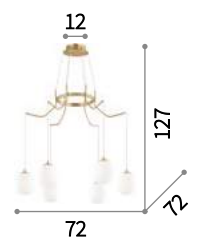

 IP20
 
  
 G9 max 10 x 15W  
 206394 SP10



 IP20
 
  
 G9 max 6 x 15W  
 206387 SP6



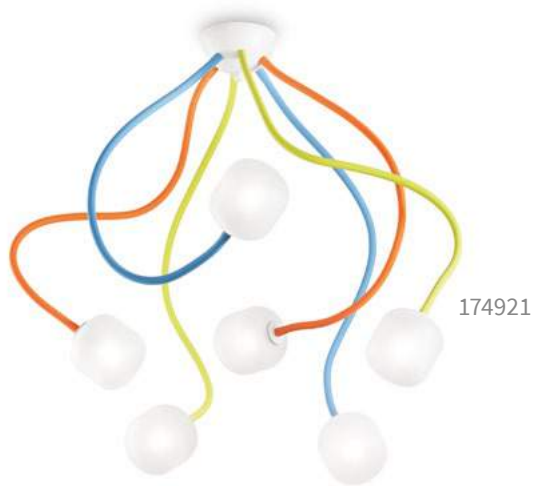



# Octopus

Base in metallo rifinito opaco. Bracci flessibili rivestiti di gomma. Diffusori in vetro trasparente soffiato e sabbato.



Lampadine ALO G9 28W 2700 K incluse.

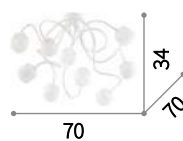

G9 max 9 x 28W

174990 PL9 Bianco  
175041 PL9 Color  
175010 PL9 Nero

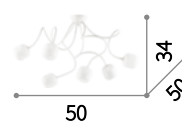

G9 max 6 x 28W

174921 PL6 Bianco  
174976 PL6 Color  
174952 PL6 Nero

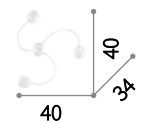

G9 max 3 x 28W

175072 AP3 Bianco  
175119 AP3 Color  
175096 AP3 Nero

175010



# Mallow

Base e bracci in metallo con finitura in vernice opaca. Diffusori in vetro trasparente soffiato e sabbato.



Lampadine ALO G9 28W 2700 K incluse.



Lampada con interruttore integrato nei modelli: TL2 e PT2.

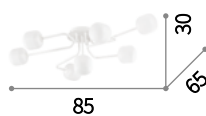

G9 max 7 x 28W

174419 PL7

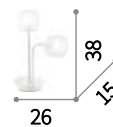

G9 max 2 x 28W

174433 TL2



G9 max 6 x 28W

174426 PT6







# Versus

Montatura in metallo cromato. Elementi decorativi con catenine metalliche a maglia quadrata. Cavi in acciaio regolabili in altezza da dispositivi blocca cavo automatici.

**LED** Sorgente luminosa LED 3000 K, 30.000 h di durata.

**ON OFF** Lampada con interruttore integrato nel modello AP40.

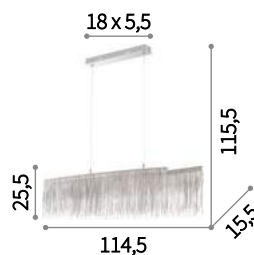

⊕ ⊖ IP20

LED 43,2W / 4300 Lm  
137056 SP216 Oval



⊕ ⊖ IP20

LED 33,6W / 3300 Lm  
137032 SP168 Round

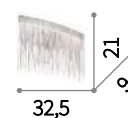

⊕ ⊖ IP20

LED 8W / 800 Lm  
137018 AP40











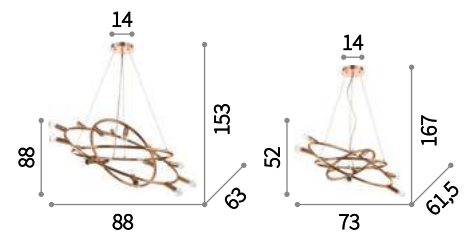

# Cosmo

Montatura in metallo con finitura in rame.  
Elementi circolari rotanti posizionabili a piacere.



 IP20  
 E14 max 15 x 40W  
 133058 SP15

 IP20  
 E14 max 9 x 40W  
 133041 SP9



# Orbital

Montatura in cromo composta da anelli concentrici ruotabili. Diffusori a sfera con decorazione interna in filamenti di vetro. Cavi in acciaio a lunghezza regolabile.



Lampadine ALO G9 28W 2700 K incluse.

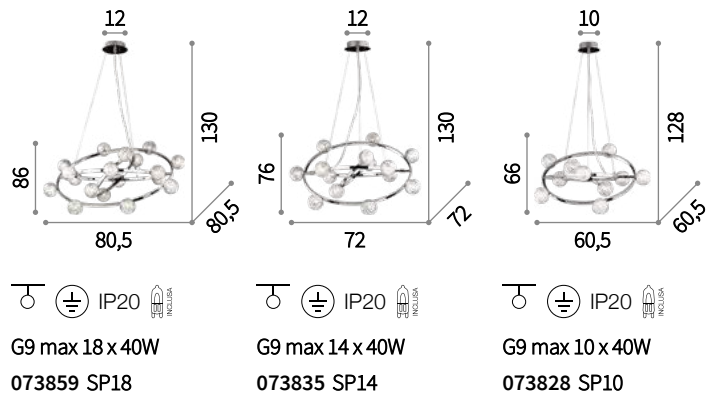



159553

## Comfort

Rosone e corpo luce in metallo verniciato opaco. Cavi in acciaio regolabili. Diffusore in vetro soffiato bianco acidato.



⊕ ⊖ IP20

E27 max 1x60W

159553 SP1 Bianco  
159560 SP1 Grigio  
186832 SP1 Nero





# Konse

Montatura ed elementi decorativi interamente in metallo. Finitura con vernice oro scuro satinato.

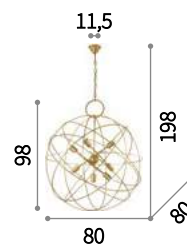

⊕ ⊖ IP20

E27 max 7 x 60W

156033 SP7

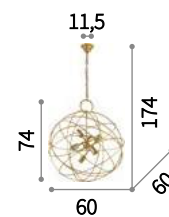

⊕ ⊖ IP20

E27 max 6 x 60W

156026 SP6

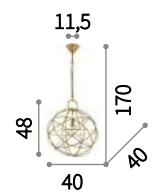

⊕ ⊖ IP20

E27 max 1 x 60W

155968 SP1



138275

## Disco

Montatura con elementi decorativi circolari rotanti e posizionabili a piacere. Disponibile in metallo verniciato in bianco o nero opaco oppure in legno naturale sagomato.

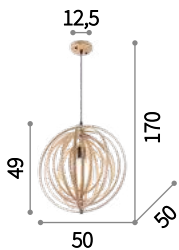

⊕ ⊖ IP20

E27 max 1 x 60W

138275 SP1 Legno

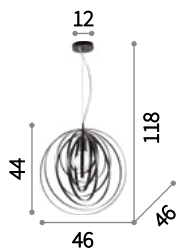

⊕ ⊖ IP20

E27 max 1 x 60W

103723 SP1 Bianco  
114262 SP1 Nero



103723



114262







165066

## Space

Montatura ed elementi decorativi  
interamente in metallo verniciato opaco.  
Cavi in acciaio regolabili in lunghezza.



165080

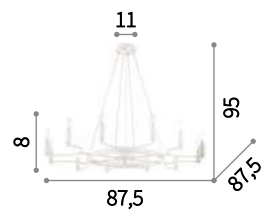

⊕ ⊖ IP20

E14 max 12 x 40W

165080 SP12 Bianco  
165066 SP12 Nero





195285

# Toronto

Montatura in metallo cromato o verniciato opaco. Cavi in acciaio regolabili. Lampadine led GX53 sostituibili.

**LED** Lampadine LED GX53 9,5W 3000 K incluse. Cod. 123936



197050

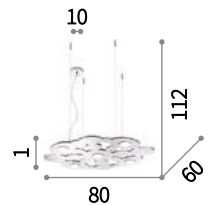

IP20

GX53 max 5 x 15W

195285 SP5 Bianco  
197050 SP5 Cromo





111940

# Leaves

Montatura in metallo. Elementi decorativi in vetro soffiato e modellato a mano. Sospensioni con cavi d'acciaio regolabili in lunghezza. Disponibile con montatura in cromo e vetri fumé o con montatura e vetri bianchi.

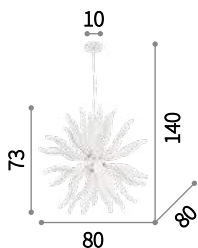
 Lampadine ALO G9 28W 2700 K incluse.



 IP20   
G9 max 12 x 40W

112268 SP12 Bianco  
112251 SP12 Fumè

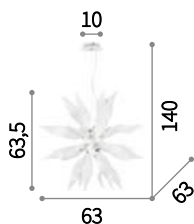

 IP20   
G9 max 8 x 40W

111957 SP8 Bianco  
111940 SP8 Fumè

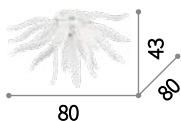

 IP20   
G9 max 6 x 40W

112299 PL6 Bianco







112268







# Corallo

Montatura a sfera e dettagli in metallo cromato. Elementi decorativi in vetro colorato lavorato a mano.

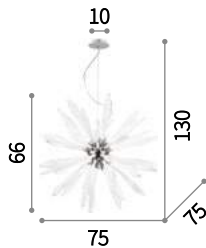



Lampadine ALO G9 28W 2700 K incluse.



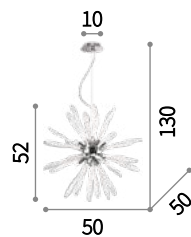



 IP20
 
  
 G9 max 12 x 40W  
 074689 SP12





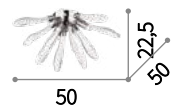

 IP20
 
  
 G9 max 8 x 40W  
 086576 SP8



 IP20
 
  
 G9 max 6 x 40W  
 074627 PL6



 IP20
 
  
 G9 max 3 x 40W  
 081960 AP3





# Pauline

Montatura in metallo cromato. Elementi decorativi in vetro soffiato e modellato a mano. Sospensioni con cavi d'acciaio regolabili in lunghezza.



Lampadine ALO G9 28W 2700 K incluse.

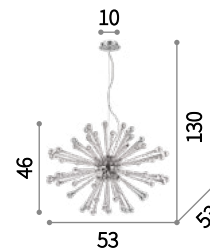

IP20 
  
 G9 max 8 x 40W
   
 115801 SP8

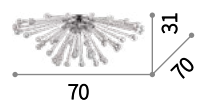

IP20 
  
 G9 max 5 x 40W
   
 111117 PL5





101613

## Vortex

Montatura in metallo verniciato bianco opaco.  
Elementi decorativi in metallo modellato  
artigianalmente e dipinti a mano con oro o  
argento.



101606

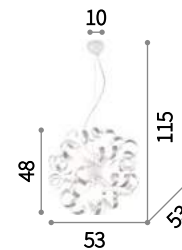

⊕ ⊖ IP20

E14 max 6 x 40W

101613 SP6 Argento  
101606 SP6 Oro

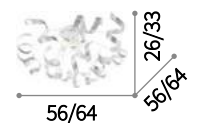

⊕ ⊖ ⊕ IP20

E14 max 3 / 5 x 40W

101576 PL3 Argento  
101590 PL5 Argento





# Dust

Montatura in tubolare di alluminio argenteo lavorato e modellato artigianalmente. Cavo elettrico regolabile in lunghezza.



Lampadine ALO G9 28W 2700 K incluse.

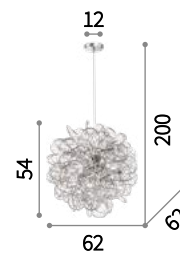

IP20 
  
 G9 max 12 x 40W
   
 114361 SP12

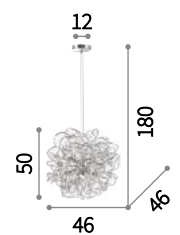

IP20 
  
 G9 max 8 x 40W
   
 114811 SP8





# Dea

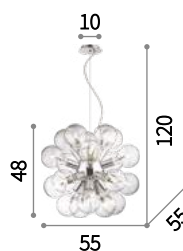

Montatura a sfera e copri portalampade in metallo cromato. Cavo in acciaio a lunghezza regolabile da dispositivo ferma cavo automatico.

**LED** Lampadine LED E27 2W Globo D125 trasparente 3000 K incluse.  
Cod. 184470



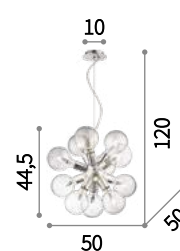



 IP20
 
  
 E27 max 20 x 42W  
 074801 SP20

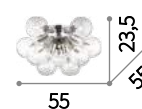

 IP20
 
  
 E27 max 12 x 42W  
 074771 SP12



 IP20
 
  
 E27 max 10 x 20W  
 074740 PL10







# Baco

Base in metallo. Diffusori in vetro soffiato con filamenti interni. Vetri trasparenti nella versione cromo, ambra nella versione ottone.

**LED** Lampadine LED G9 3,2W 3000 K incluse. Cod. 209043



⊕ ⊖ IP20 

G9 max 10 x 15W  
 199795 SP10 Cromo  
 199801 SP10 Ottone





199795



100883



100913



# Clown

Montatura in metallo con diffusori in vetro soffiato e modellato a mano. Disponibile con montatura in cromo e vetri multicolor o cromati o con montatura e vetri bianchi.





Lampadine ALO G9 28W 2700 K incluse.



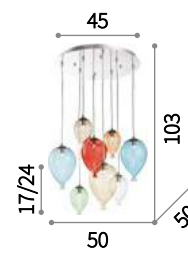



 IP20 
  
 G9 max 12 x 28W  
 100951 SP12 Color

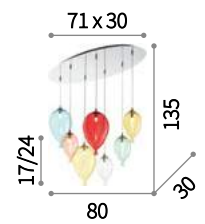

 IP20 
  
 G9 max 8 x 28W  
 100883 SP8 Bianco  
 100944 SP8 Color  
 100913 SP8 Cromo



 IP20 
  
 G9 max 7 x 28W  
 100937 SP7 Color





100951



# Nodi Cromo

Montatura in metallo con finitura cromo.  
Diffusori in vetro trasparente soffiato e cromato. Cavi in acciaio regolabili.

**LED** Lampadine LED G4 2W 3000 K incluse nel modello AP5. Cod. 222257

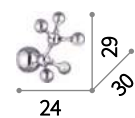
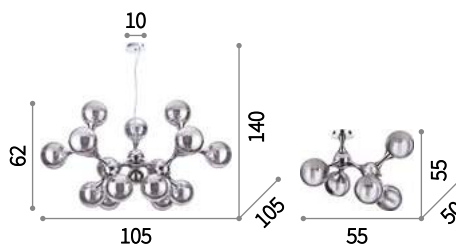

⊕ ⊖ IP20

E14 max 15 x 40W  
200491 SP15

⊕ ⊖ IP20

E14 max 5 x 40W  
200484 PL5

⊕ ⊖ IP20

G4 max 5 x 2W  
200477 AP5

LED  
TECNOLOGIA







073712



022277



## Nodi Bianco

Montatura in metallo cromato. Elementi di giunzione ruotabili per una disposizione personalizzata. Diffusori in vetro bianco soffiato e acidato disponibili in due versioni: diametro 6 cm, diametro 15 cm.



Lampadine ALO G4 20W 2700 K incluse nel modello AP5.

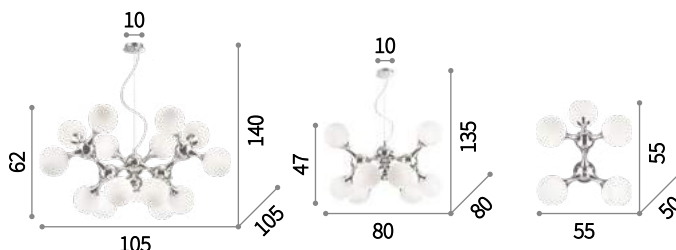

⊕ ⊖ IP20

E14 max 15 x 40W  
082073 SP15

⊕ ⊖ IP20

E14 max 9 x 40W  
082059 SP9

⊕ ⊖ IP20

E14 max 5 x 40W  
073712 PL5

⊕ ⊖ IP20

G4 max 5 x 20W  
022277 AP5





087924

# Bollicine

Elementi decorativi con bolle di vetro soffiato. Disponibile con bolle trasparenti e bianche o trasparenti e cromo.

 Lampadine ALO G9 28W 2700 K incluse.



093024



 IP20 

G9 max 14 x 40W

087924 SP14 Bianco  
093024 SP14 Cromo





# Quasar

Montatura in cromo. Vetri in canna di pirex sagomati a mano. Sospensioni con cavi in acciaio a lunghezza regolabile da dispositivi automatici.



Lampadine ALO G9 28W 2700 K incluse.

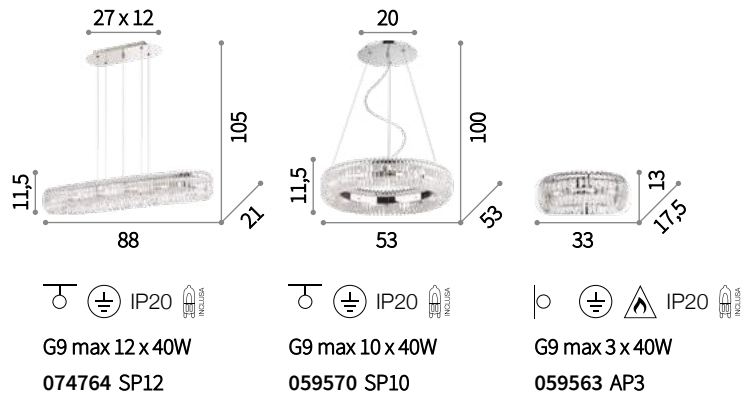
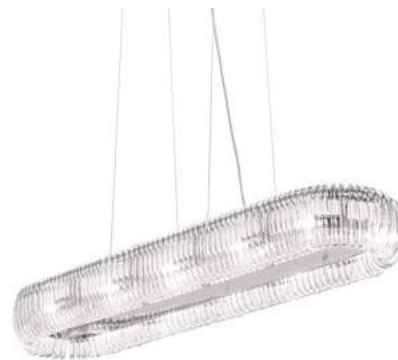









# Neve

Montatura in metallo. Elementi decorativi con sfere di vetro fissate a fili di nylon. Disponibile con montatura cromata e sfere trasparenti o con montatura in bianco opaco e sfere bianche e trasparenti.

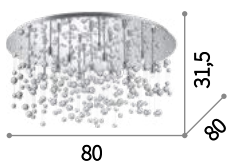

 Lampadine ALO G9 28W 2700 K incluse.

 Lampada con interruttore integrato nel modello TL1.



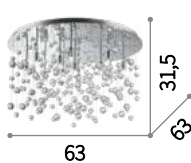

   IP20  
G9 max 15 x 40W  
101194 PL15 Bianco  
030784 PL15 Cromo



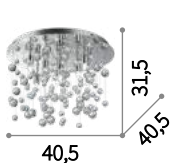

   IP20  
G9 max 12 x 40W  
101187 PL12 Bianco  
022239 PL12 Cromo



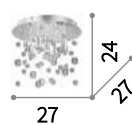



   IP20  
G9 max 8 x 40W  
101170 PL8 Bianco  
022222 PL8 Cromo

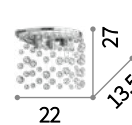



   IP20  
G9 max 5 x 40W  
094687 PL5 Cromo

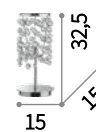

   IP20   
G9 max 3 x 40W  
106021 AP3 Bianco  
033938 AP3 Cromo



   IP20  
G9 max 1 x 40W  
033945 TL1 Cromo





# Audi-80

Montatura in metallo cromato. Elementi decorativi con sfere di vetro su fili di metallo. Diffusore in vetro soffiato. Cavi in acciaio a lunghezza regolabile con ferma cavo automatici.



Lampadine ALO G9 28W 2700 K incluse.

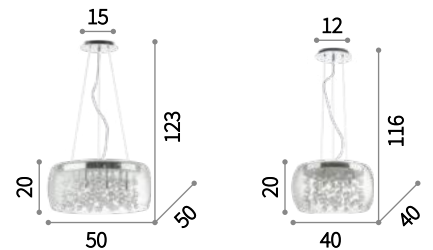

G9 max 8 x 40W  
197654 SP8 Fumè  
031750 SP8 Trasparente



G9 max 5 x 40W  
197661 SP5 Fumè  
031743 SP5 Trasparente





031750





# Elysee

Montatura con bracci in fusione di metallo. Copri catena in velluto.  
L'impiego di lampadine da 20W garantisce un'elevata luminosità.



Lampadine ALO G4 20W 2700 K  
includ.

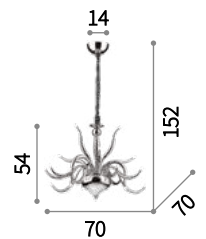

IP20

G4 max 18x20W



054995 SP18



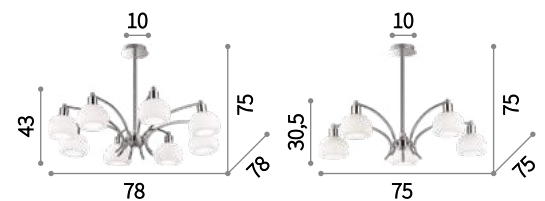

# Tokyo

Montatura in metallo cromato regolabile in altezza. Diffusori in vetro soffiato bianco incamiciato e acidato.



 IP20  
 E14 max 8 x 40W  
 068466 SP8

 IP20  
 E14 max 5 x 40W  
 068459 SP5





# Rain Clear

Montatura ellittica in cromo. Pendagli con elementi in cristallo molato ottagonali, quadrati, rettangolari e gocce finali. Sospensioni con cavi in acciaio a lunghezza regolabile.

**ON** Lampada con interruttore  
**OFF** integrato nei modelli: TL2 e PT2.

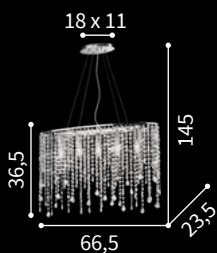

IP20  
E14 max 5 x 40W  
**008363** SP5

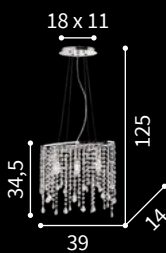

IP20  
E14 max 3 x 40W  
**008349** SP3

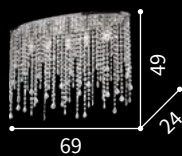

IP20  
E14 max 5 x 40W  
**008455** PL5

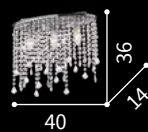

IP20  
E14 max 3 x 40W  
**008370** PL3

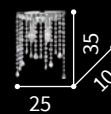

IP20  
E14 max 2 x 40W  
**008325** AP2

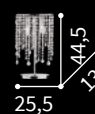

IP20  
E14 max 2 x 40W  
**008356** TL2



♀ □ IP20

E14 max 2 x 40W

080277 PT2





# Rain Color

Montatura in metallo cromato. Pendagli con elementi in cristallo colorato e molato in varie forme e gocce finali. Sospensioni con cavi in acciaio a lunghezza regolabile.

**ON** Lampada con interruttore integrato  
**OFF** nel modello TL1.

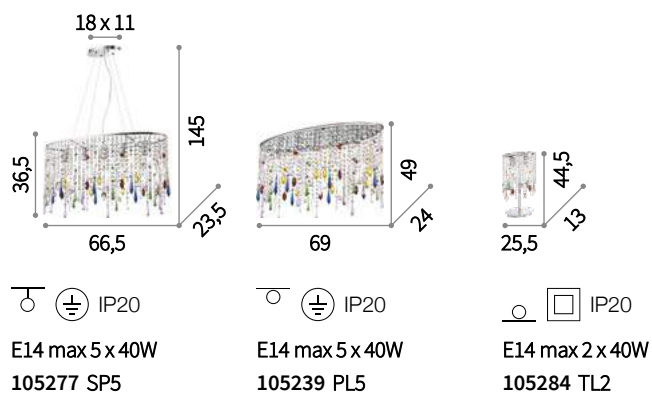





# Giada Clear

Montatura in metallo cromato. Pendagli con elementi ottagonali e puntali finali in cristallo molato. Sospensioni con cavi in acciaio a lunghezza regolabile.



Lampadine ALO G9 28W 2700 K incluse.

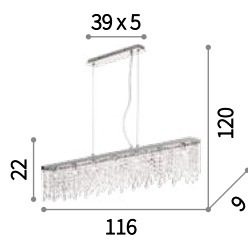

IP20



G9 max 7 x 40W

098739 SP7

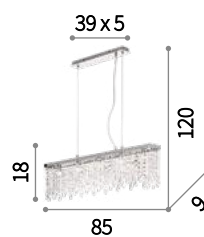

IP20



G9 max 5 x 40W

098722 SP5

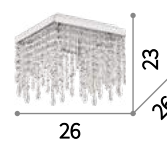

IP20



G9 max 4 x 40W

098777 PL4

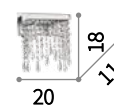

IP20



G9 max 2 x 40W

098784 AP2









# Giada Color

Montatura in metallo cromato. Pendagli con elementi ottagonali e puntali finali in cristallo molato multicolor. Sospensioni con cavi in acciaio a lunghezza regolabile.



Lampadine ALO G9 28W 2700 K incluse.

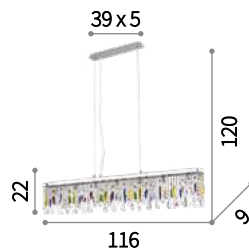

G9 max 7 x 40W  
099170 SP7

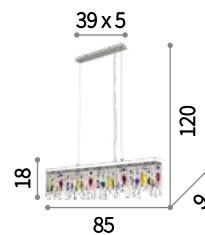

G9 max 5 x 40W  
099163 SP5

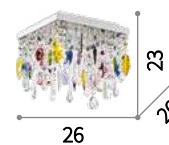

G9 max 4 x 40W  
099200 PL4

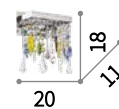

G9 max 2 x 40W  
099217 AP2





# Aurora

Montatura in metallo cromato. Pendagli con elementi in cristallo molato ottagonali. Sospensioni con cavi in acciaio a lunghezza regolabile da dispositivi automatici.

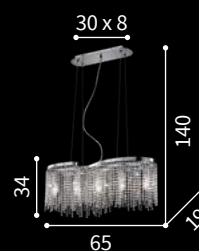

⊕ ⊖ IP20

E14 max 5 x 40W

**013923** SP5

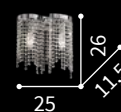

⊕ ⊖ IP20

E14 max 2 x 40W

**013763** AP2



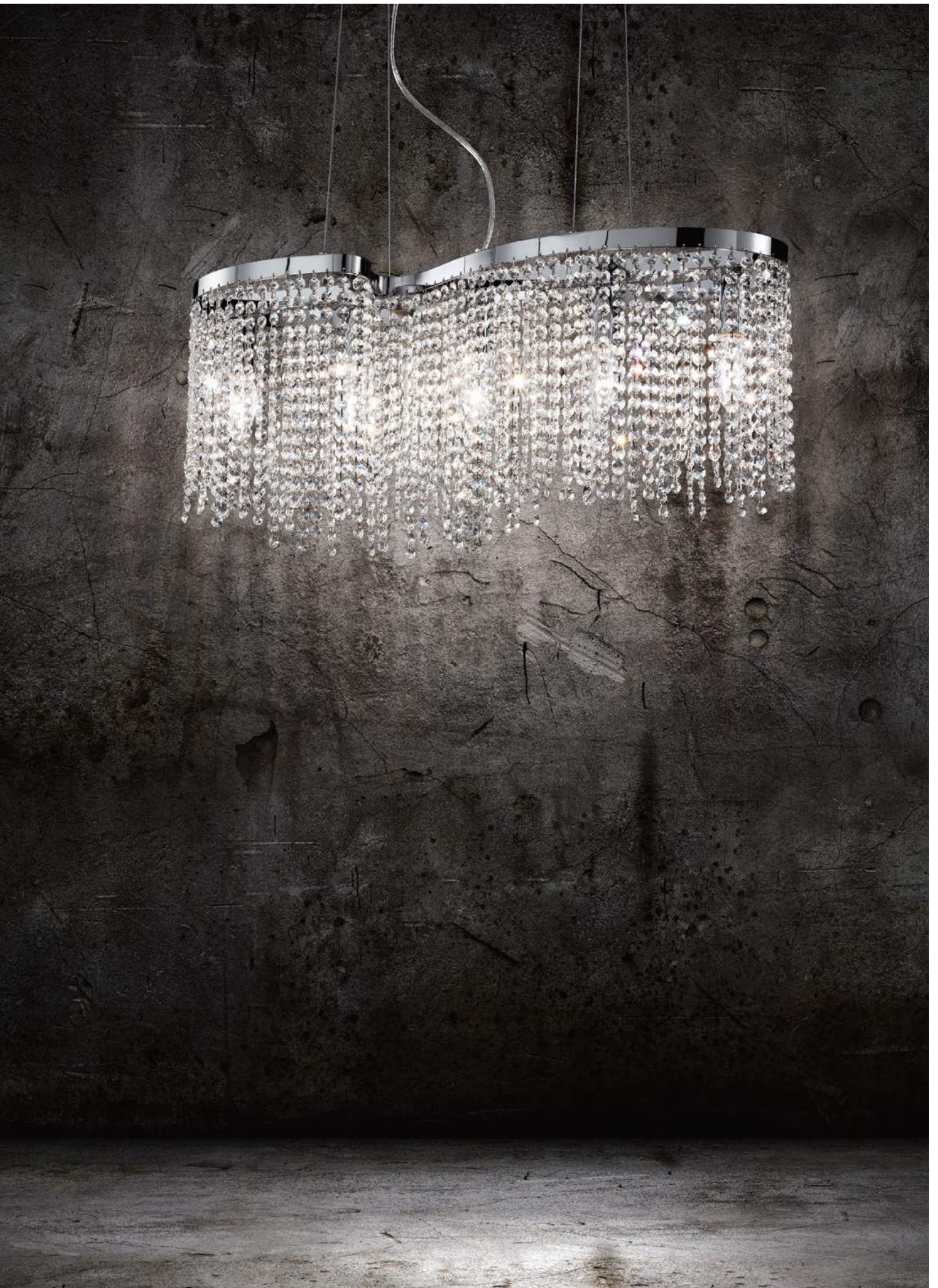





# Roma

Montatura e dettagli in metallo cromato. Diffusore con elementi quadrati in cristallo molato sulla fascia laterale e vetro sabbato sul fondo. Sospensioni con cavi a lunghezza regolabile.



Lampadine ALO G9 28W 2700 K incluse.



Lampada con interruttore integrato nel modello TL1.

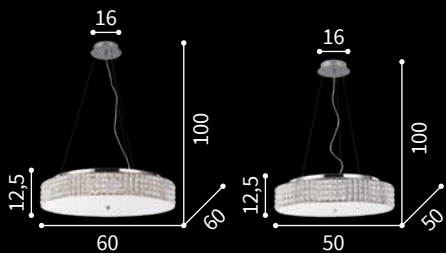

G9 max 12 x 40W  
**093062 SP12**

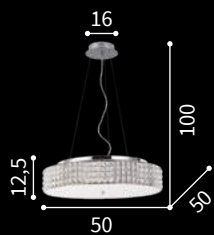

G9 max 9 x 40W  
**093048 SP9**



G9 max 12 x 40W  
**087870 PL12**



G9 max 9 x 40W  
**087863 PL9**



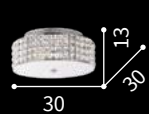

G9 max 6 x 40W  
**000657 PL6**



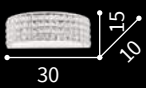

G9 max 4 x 40W  
**093093 PL4**

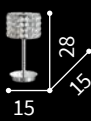

 IP20
 
  
 G9 max 2 x 40W
   
**093086 AP2**



 IP20
 
  
 G9 max 1 x 40W
   
**114620 TL1**





073262

# King

Diffusore composto da anelli in metallo cromato o dorato con ottagononi di cristallo incastonati all'interno. Sospensioni con cavi in acciaio a lunghezza regolabile da dispositivi automatici.



Lampadine ALO G9 28W 2700 K incluse.

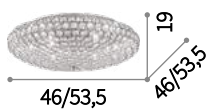
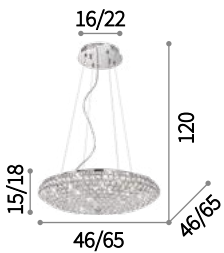

G9 max 7 / 12 x 40W

087979 SP7 Cromo  
088013 SP12 Cromo  
088020 SP12 Oro



G9 max 7 / 9 x 40W

073224 PL7 Cromo  
073255 PL9 Cromo  
073262 PL9 Oro



G9 max 3 / 5 x 40W

075389 PL3 Cromo  
075402 PL3 Oro  
075419 PL5 Cromo  
073187 PL5 Oro



088013







# Orion

Diffusore composto da anelli in metallo cromato con ottagoni di cristallo incastonati all'interno. Sospensioni con cavi in acciaio regolabili in lunghezza da dispositivi automatici.



Lampadine ALO G9 28W 2700 K incluse nei modelli: PL12, PL7, PL5, PL3, AP2 e TL1.



Lampada con interruttore integrato nel modello TL1.



E14 max 6 / 8 / 12 x 40W

059181 SP6  
066387 SP8  
066394 SP12

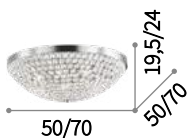

G9 max 7 / 12 x 40W

059150 PL7  
059129 PL12



G9 max 3 / 5 x 40W

059136 PL3  
059143 PL5



G9 max 2 x 40W

059112 AP2



G9 max 1 x 40W

059198 TL1









# Virgin

Montatura in metallo cromato. Elementi decorativi di cristallo molato in forma di perle e quadrati di varie misure.



Lampadine ALO G9 28W 2700 K incluse.

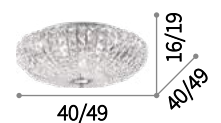

G9 max 6 x 40W

023328 SP6



G9 max 5 / 6 x 40W

018089 PL5  
016122 PL6







# Spirit

Montatura in metallo cromato. Pendagli con elementi in cristallo molato. Sospensioni con cavi in acciaio a lunghezza regolabile.

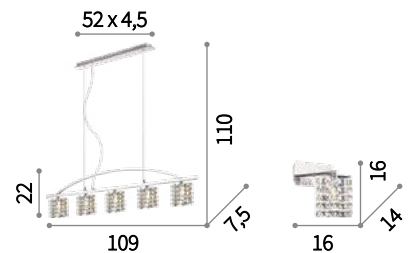

Lampadine ALO G9 28W 2700 K incluse.



 IP20   
 G9 max 5 x 40W  
 068398 SP5



 IP20   
 G9 max 1 x 40W  
 068350 AP1





# Admiral

Diffusore composto da anelli in metallo saldati tra loro e da elementi in cristallo molato incastonati all'interno.





Lampadine ALO G9 28W 2700 K incluse.



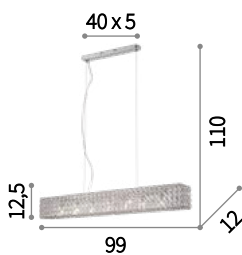



Lampada con interruttore integrato nel modello TL1.

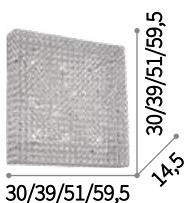





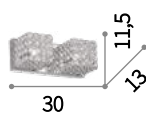

 IP20
  INCLUSA  
 G9 max 7 x 40W  
 080369 SP7







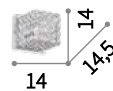

 IP20
  INCLUSA  
 G9 max 4 / 6 / 8 / 10 x 40W  
 080338 PL4  
 080345 PL6  
 080352 PL8  
 080291 PL10





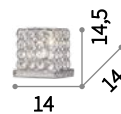

 IP20
  INCLUSA  
 G9 max 2 x 40W  
 080857 AP2





 IP20
  INCLUSA  
 G9 max 1 x 40W  
 080284 AP1



 IP20
  INCLUSA  
 G9 max 1 x 40W  
 080376 TL1





# Quadro

Base quadrata ed elementi porta lampade in metallo cromato. Corpo luce cubico con facciate di reticolo a maglia larga con spessore di 2,5 mm in fusione d'alluminio.





Lampadine ALO G9 28W 2700 K incluse.



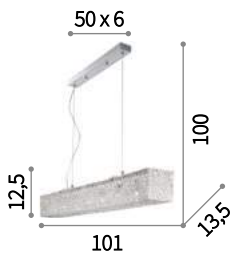

Lampada con interruttore integrato nel modello TL1.



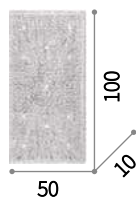



 IP20   
 G9 max 6 x 40W  
 062501 SP6

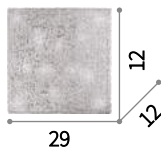



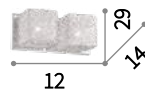

 IP20   
 G9 max 11 x 40W  
 036045 PL11





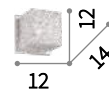

 IP20   
 G9 max 8 / 12 x 40W  
 031668 PL8  
 031651 PL12





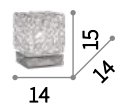

 IP20   
 G9 max 2 x 40W  
 031675 AP2



 IP20   
 G9 max 1 x 40W  
 031644 AP1



 IP20   
 G9 max 1 x 40W  
 004686 TL1







077802







# Moonlight

Montatura in metallo con finitura disponibile in cromo o dorato. Pendagli con ottagoni e sfere in cristallo molato.

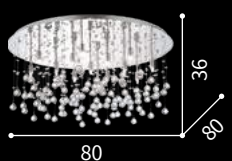
 Lampadine ALO G9 28W 2700 K incluse.



 Lampada con interruttore integrato nel modello TL1.



  IP20   
G9 max 15 x 40W

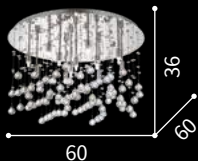

**077819** PL15 Cromo  
**082790** PL15 Oro



  IP20   
G9 max 12 x 40W

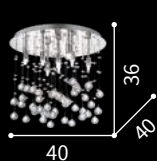

**077802** PL12 Cromo  
**082783** PL12 Oro

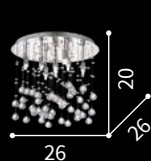

  IP20   
G9 max 8 x 40W

**077796** PL8 Cromo  
**080932** PL8 Oro



  IP20   
G9 max 5 x 40W

**094649** PL5 Cromo  
**094663** PL5 Oro

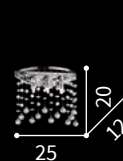

  IP20   
G9 max 3 x 40W

**077833** AP3 Cromo  
**082813** AP3 Oro



  IP20   
G9 max 1 x 40W

**077826** TL1 Cromo  
**082806** TL1 Oro

082790





# Royal

Montatura circolare e portalampade in metallo cromato. Pendagli con elementi in cristallo molato ottagonali, quadrati, rettangolari e gocce finali.





Lampadine ALO G9 28W 2700 K incluse.



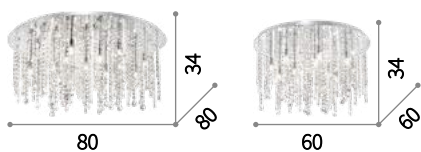

Lampada con interruttore integrato nel modello TL1.



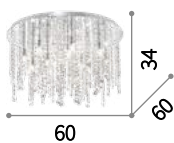



 IP20
  INCLUSA  
 G9 max 15 x 40W  
 053011 PL15

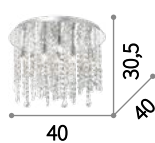



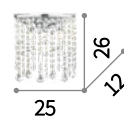

 IP20
  INCLUSA  
 G9 max 12 x 40W  
 053004 PL12







 IP20
  INCLUSA  
 G9 max 8 x 40W  
 052991 PL8





 IP20
  INCLUSA  
 G9 max 3 x 40W  
 052984 AP3



 IP20
  INCLUSA  
 G9 max 1 x 40W  
 053028 TL1













# Gocce

Montatura in metallo cromato. Diffusore in tubolare di vetro pirex. Elementi decorativi con ottagoni e gocce in cristallo molato. Cavi elettrici regolabili in lunghezza.

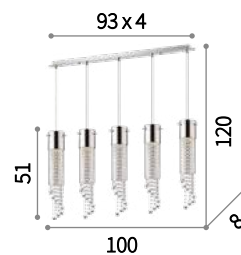



Lampadine ALO GU10 28W 2700 K incluse.



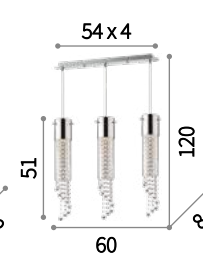



 IP20
  INCLUSA  
 GU10 max 5 x 28W  
 089638 SP5

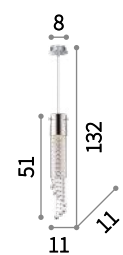

 IP20
  INCLUSA  
 GU10 max 3 x 28W  
 091143 SP3





 IP20
  INCLUSA  
 GU 10 max 1 x 28W  
 089669 SP1

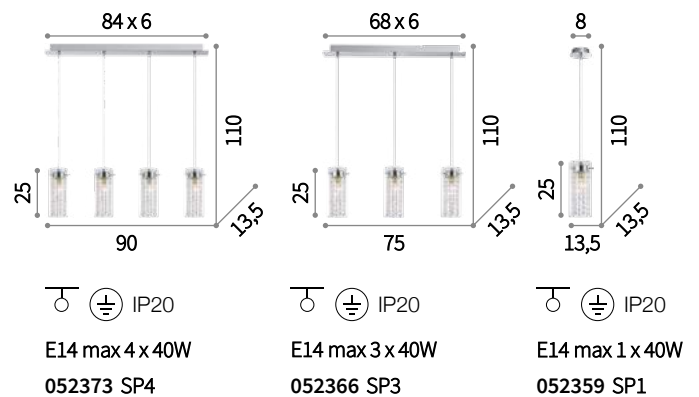

# Iguazù

Montatura in metallo cromato. Diffusore in vetro pirex e pendenti con ottagoni di cristallo. Sospensioni con cavi a lunghezza regolabile da dispositivi ferma cavo automatici.







# Calypso

Montatura in metallo cromato. Elementi decorativi in cristallo molato. Sospensioni con cavi in acciaio a lunghezza regolabile da dispositivi ferma cavo automatici.



Lampadine ALO G9 28W 2700 K incluse nei modelli: SP1 e AP2.



⊕ ⊖ IP20

E27 max 3 / 5 x 60W

044194 SP3  
044200 SP5



⊕ ⊖ IP20

G9 max 1 x 40W

044187 SP1



⊕ ⊖ IP20

E14 max 4 / 6 / 8 x 40W

066400 PL4  
066417 PL6  
066424 PL8

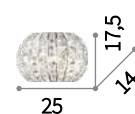

⊕ ⊖ IP20

G9 max 2 x 40W

044163 AP2







# Audi-61

Montatura in metallo cromato. Catene di ottagoni in cristallo. Diffusore in vetro soffiato. Sospensioni con cavi in acciaio a lunghezza regolabile da dispositivi automatici.



Lampadine ALO G9 28W 2700 K incluse.

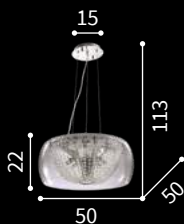

IP20
   
 G9 max 8 x 40W
   
**133881 SP8**

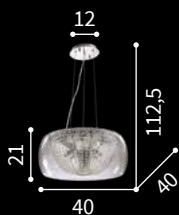

IP20
   
 G9 max 6 x 40W
   
**133874 SP6**

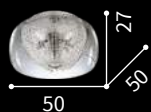

IP20
   
 G9 max 8 x 40W
   
**133904 PL8**

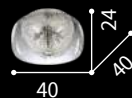

IP20
   
 G9 max 6 x 40W
   
**133898 PL6**

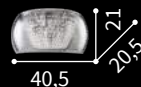

IP20
   
 G9 max 4 x 40W
   
**133911 AP4**





# Tall

Diffusore e dettagli in metallo verniciato opaco. Modello SMALL con led integrato e schermo opale. Modello BIG aperto e con lampadina sostituibile.

**LED** Sorgente luminosa LED 3000 K nel modello SP1 Small, 20.000 h di durata.

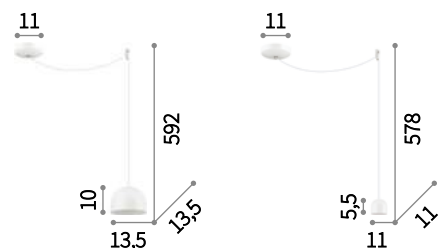

⊕ ⊖ IP20

E27 max 1 x 42W  
 196770 SP1 Big Bianco  
 196787 SP1 Big Nero

⊕ ⊖ IP20

LED 4,5W / 510Lm  
 196794 SP1 Small Bianco  
 196800 SP1 Small Nero





196770



# Oil

Montatura in metallo con finitura nero opaco. Diffusore in cemento. Oil-4 SP1 fornito con sei ganci di fissaggio, 12 metri di cavo in tessuto nero e spina italiana che può essere sostituita al rosone.



144320

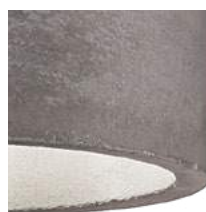

110417

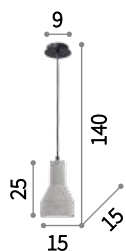

IP20

E27 max 1 x 15W

110417 Oil-1 SP1 Cemento  
144320 Oil-1 SP1 Terracotta

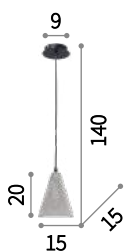

IP20

E27 max 1 x 15W

110424 Oil-2 SP1 Cemento

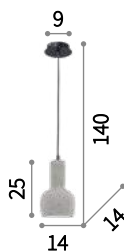

IP20

E27 max 1 x 15W

110431 Oil-3 SP1 Cemento

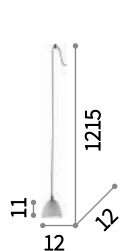

IP20

GU10 max 1 x 15W

110462 Oil-4 SP1 Cemento



IP20

E27 max 1 x 15W

129082 Oil-5 SP1 Cemento

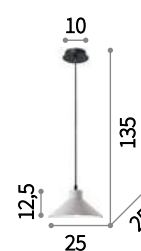

IP20

E27 max 1 x 15W

129099 Oil-6 SP1 Cemento







# Radio

Rosone e montatura in metallo. Diffusore posizionabile. Cavo elettrico in tessuto. Disponibile con finitura in cromo o con vernice opaca bianca o nera.

**LED** Lampadine LED E27 8W Globo D125 trasparente 3000 K incluse. Cod. 101347

**ON OFF** Lampada con interruttore integrato nei modelli: TL1 e PT2.

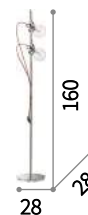
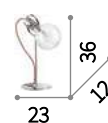
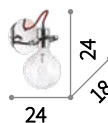
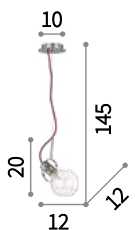
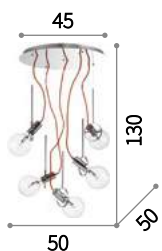

E27 max 5 x 60W

141138 SP5 Bianco  
141145 SP5 Cromo



E27 max 1 x 60W

122847 SP1 Bianco  
113333 SP1 Cromo  
113364 SP1 Nero



E27 max 1 x 60W

119465 AP1 Bianco  
119427 AP1 Cromo  
119502 AP1 Nero



E27 max 1 x 60W

141107 TL1 Bianco  
113357 TL1 Cromo



E27 max 2 x 60W

119458 PT2 Bianco  
119410 PT2 Cromo







# Minimal

Montatura in metallo rifinito in cromo o in smalto colorato. Cavo elettrico con rivestimento in tessuto. Sospensioni SP1 fornite con due metri di cavo.

**LED** Lampadine LED E27 8W Globo D125 trasparente 3000 K incluse. Cod. 101347

**ON OFF** Lampada con interruttore integrato nel modello PT1.

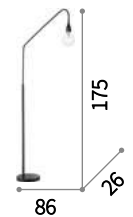
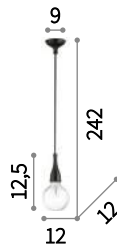
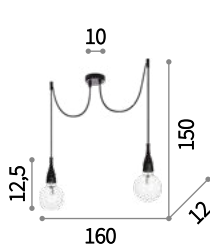

E27 max 2 x 60W

E27 max 1 x 70W

E27 max 1 x 60W

E27 max 1 x 60W

112718 SP2 Bianco opaco  
112671 SP2 Nero opaco

063614 SP1 Azzurro  
009360 SP1 Bianco  
009384 SP1 Cromo  
063621 SP1 Giallo  
101118 SP1 Grigio

009407 SP1 Nero  
009391 SP1 Oro  
009414 SP1 Rosso

045191 AP1 Bianco  
045207 AP1 Cromo  
045214 AP1 Nero  
045221 AP1 Rosso

163369 PT1 Nero





009391

009414

063621

009360

063614

009407

101118

# Hugo

Rosone e corpo luce in metallo con  
finitura in vernice opaca bianca o nera.  
Cavo elettrico rivestito in tessuto.

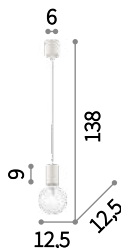

E27 max 1 x 60W

139678 SP1 Bianco  
139685 SP1 Nero

139678

139685



# It

Rosone e copriportalampade in metallo  
con finitura in smalto opaco nero. Cavo in  
tessuto.

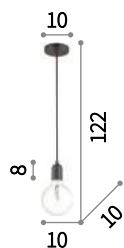

E27 max 1 x 60W

175935 SP1







# Edison

Montatura in metallo rifinito in cromo o in smalto opaco bianco o nero. Cavo elettrico in tessuto.

**LED** Lampadine LED E27 8W Globo D125 trasparente 3000 K incluse nel modello SP1. Cod. 101347

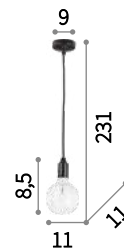

E27 max 1 x 60W  
113302 SP1 Bianco  
113319 SP1 Nero



E27 max 1 x 60W  
138374 AP1 Bianco  
138367 AP1 Cromo  
148908 AP1 Nero







# Mr Jack

Montatura e diffusore sferico in metallo rifinito in cromo. Cavo elettrico rivestito in tessuto.

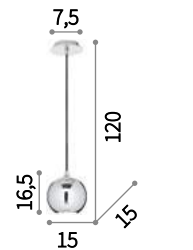
**LED** Lampadine LED GU10 5W 3000 K include. Cod.108292



  
 GU10 max 1 x 28W  
 116464 SP1 Big

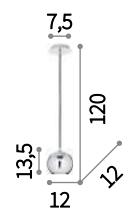

  
 GU10 max 1 x 28W  
 116457 SP1 Small



005218

# Pandora

Montatura e diffusore in metallo con interno smaltato bianco. Esterno disponibile in nickel o bianco opaco. Cavo elettrico regolabile in lunghezza.



038261

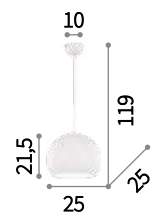

⊕ ⊖ IP20

E27 max 1x60W

005218 SP1 Bianco  
038261 SP1 Nickel



# Look

Rosone e diffusore in metallo con varie finiture. Cavo in tessuto regolabile in lunghezza. Monta lampadine sostituibili.

 Lampadine ALO GU10 28W e ALO GU10 50W 2700 K incluse.



104935



141800



104942



104928



141817



141794



141855



170589

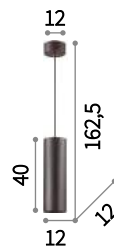

GU10 max 1 x 50W

- 158655 SP1 Big Bianco
- 187686 SP1 Big Corten
- 158686 SP1 Big Cromo
- 158723 SP1 Big Nero

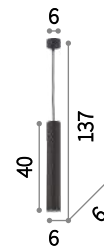

GU10 max 1 x 28W

- 141800 SP1 Small Argento
- 104935 SP1 Small Bianco
- 141794 SP1 Small Brunito
- 170589 SP1 Small Corten
- 104942 SP1 Small Cromo
- 194806 SP1 Small Cromo Sfum.
- 104928 SP1 Small Nero
- 141817 SP1 Small Oro
- 141855 SP1 Small Rame









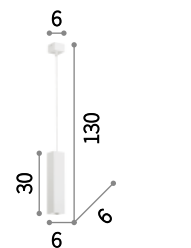

# Sky

Rosone e diffusore in metallo con varie finiture. Cavo elettrico regolabile in lunghezza.

 Lampadine ALO GU10 28W 2700 K incluse.



  IP20  INCLUSA

GU10 max 1 x 28W

136929 SP1 Argento  
126906 SP1 Bianco  
170596 SP1 Corten  
136943 SP1 Cromo  
126913 SP1 Nero  
136936 SP1 Oro

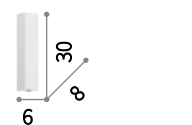

  IP20  INCLUSA

GU10 max 2 x 28W

136882 AP2 Argento  
126883 AP2 Bianco  
170602 AP2 Corten  
136905 AP2 Cromo  
126890 AP2 Nero  
136899 AP2 Oro



126906





# Bar

Diffusore in tubolare di vetro pirex con fascia centrale sabbiata. Cavi elettrici regolabili in lunghezza.



Lampadine ALO G9 28W 2700 K incluse.

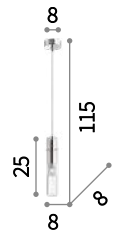

G9 max 1 x 40W



089614 SP1



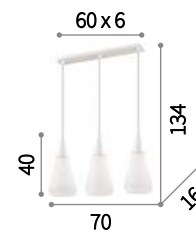

# Wave

Montatura in metallo rifinito opaco. Cavi in tessuto. Diffusori in vetro incamiciato bianco soffiato e acidato.

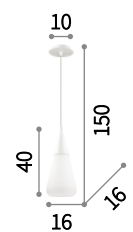

 IP20  
 E27 max 3 x 60W  
 176277 SP3





 IP20  
 E27 max 1 x 60W  
 176260 SP1



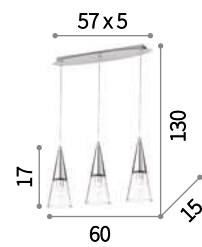

# Cono

Montatura e copri porta lampade in metallo cromato o bianco satinato. Diffusore in vetro soffiato a mano. Disponibile in bianco con vetro trasparente e fascia sabbiata, o in cromo con vetro tutto trasparente.



⊕ ⊖ IP20

E14 max 3 x 40W

112381 SP3 Bianco  
112367 SP3 Cromo

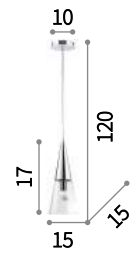

⊕ ⊖ IP20

E14 max 1 x 40W

112459 SP1 Bianco  
017440 SP1 Cromo





023038

# Kuky

Montatura in metallo cromato. Disponibile con vetro pirex smerigliato a sabbia nella zona centrale o vetro bianco soffiato e acidato.



053448

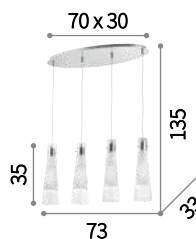

⊕ ⊖ IP20

E27 max 4 x 60W

053455 SP4 Bianco  
023038 SP4 Trasparente

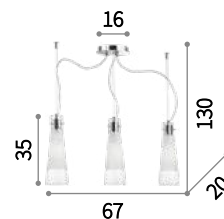

⊕ ⊖ IP20

E27 max 3 x 60W

033952 SP3 Trasparente

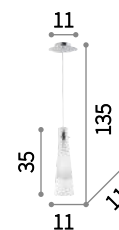

⊕ ⊖ IP20

E27 max 1 x 60W

053448 SP1 Bianco  
023021 SP1 Trasparente



# Flam

Diffusore in vetro pirex smerigliato nella zona centrale. SP3 con cavi in acciaio a lunghezza regolabile da dispositivi ferma cavo automatici.

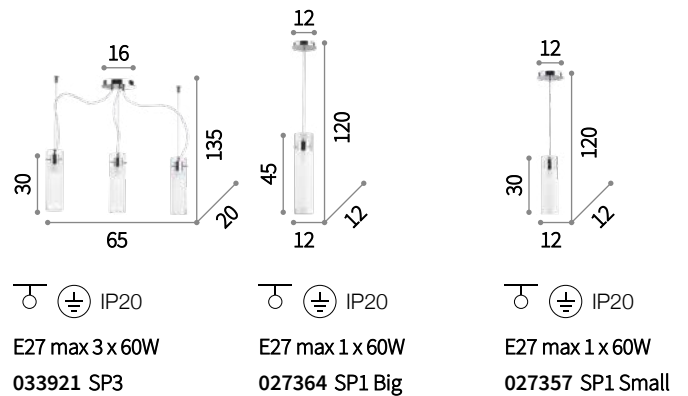





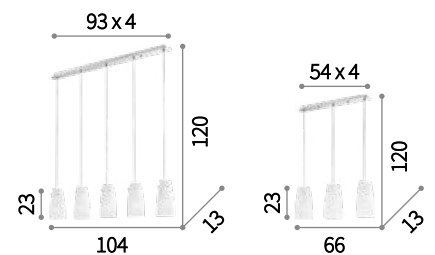

# Sugar

Montatura in metallo cromato. Diffusore in vetro trasparente soffiato e decorato a mano con graniglia all'interno.



 IP20  
 E27 max 5 x 60W  
 090764 SP5

 IP20  
 E27 max 3 x 60W  
 008776 SP3





016863

## Audi-10

Montatura in metallo cromato. Diffusore in vetro soffiato trasparente o fumè. Cavi in acciaio a lunghezza regolabile con dispositivi ferma cavo automatici.

**LED** Lampadine LED E27 8W Globo D95 3000 K incluse. Cod. 101330/101323



103983

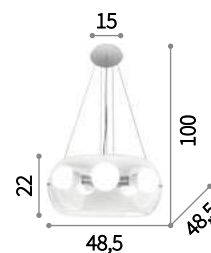

E27 max 5x 60W

103983 SP5 Fumè

016863 SP5 Trasparente

# Audi-20

Elemento centrale portalampada in metallo cromato. Diffusore in vetro soffiato trasparente o cromo sfumato. Cavo in acciaio a lunghezza regolabile con dispositivo ferma cavo automatico.

**LED** Lampadine LED E27 8W Globo D125 3000 K incluse. Cod. 101347/101354

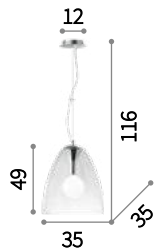

E27 max 1 x 100W

103990 SP1 Cromo Sfumato  
016931 SP1 Trasparente



# Ken

Montatura in metallo cromato. Diffusore in vetro soffiato. Cavi in acciaio a lunghezza regolabile con dispositivi ferma cavo automatici.

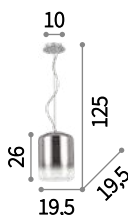
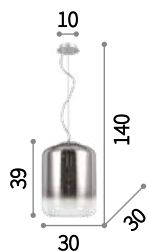

E27 max 1 x 60W

112107 SP1 Big



E27 max 1 x 60W

112084 SP1 Small





176000

# Mapa Sat

Montatura in metallo con finitura nickel o ottone. Diffusore in vetro soffiato trasparente con decoro interno in filo d'alluminio.



176031



⊕ ⊖ IP20

E27 max 7 x 60W

**176062** SP7 Nickel  
**176000** SP7 Ottone



⊕ ⊖ IP20

E27 max 3 x 60W

**176031** SP3 Nickel  
**175973** SP3 Ottone





# Mapa Max

Montatura in cromo. Diffusore in vetro soffiato con decorazione interna in filo d'alluminio. Sospensioni con cavo in acciaio a lunghezza regolabile da dispositivo ferma cavo automatico.

**ON** Lampada con interruttore integrato  
**OFF** nei modelli: TL1 D20 e TL1 D30.

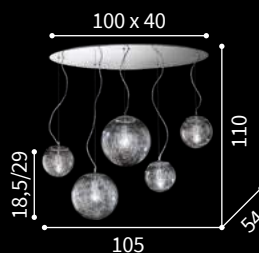

IP20

E27 max 5 x 60W

**091112** SP5

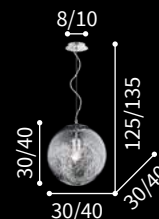

IP20

E27 max 1 x 60W

**045115** SP1 D30  
**045122** SP1 D40



IP20

E27 max 1 x 60W

**045139** TL1 D20  
**045146** TL1 D30

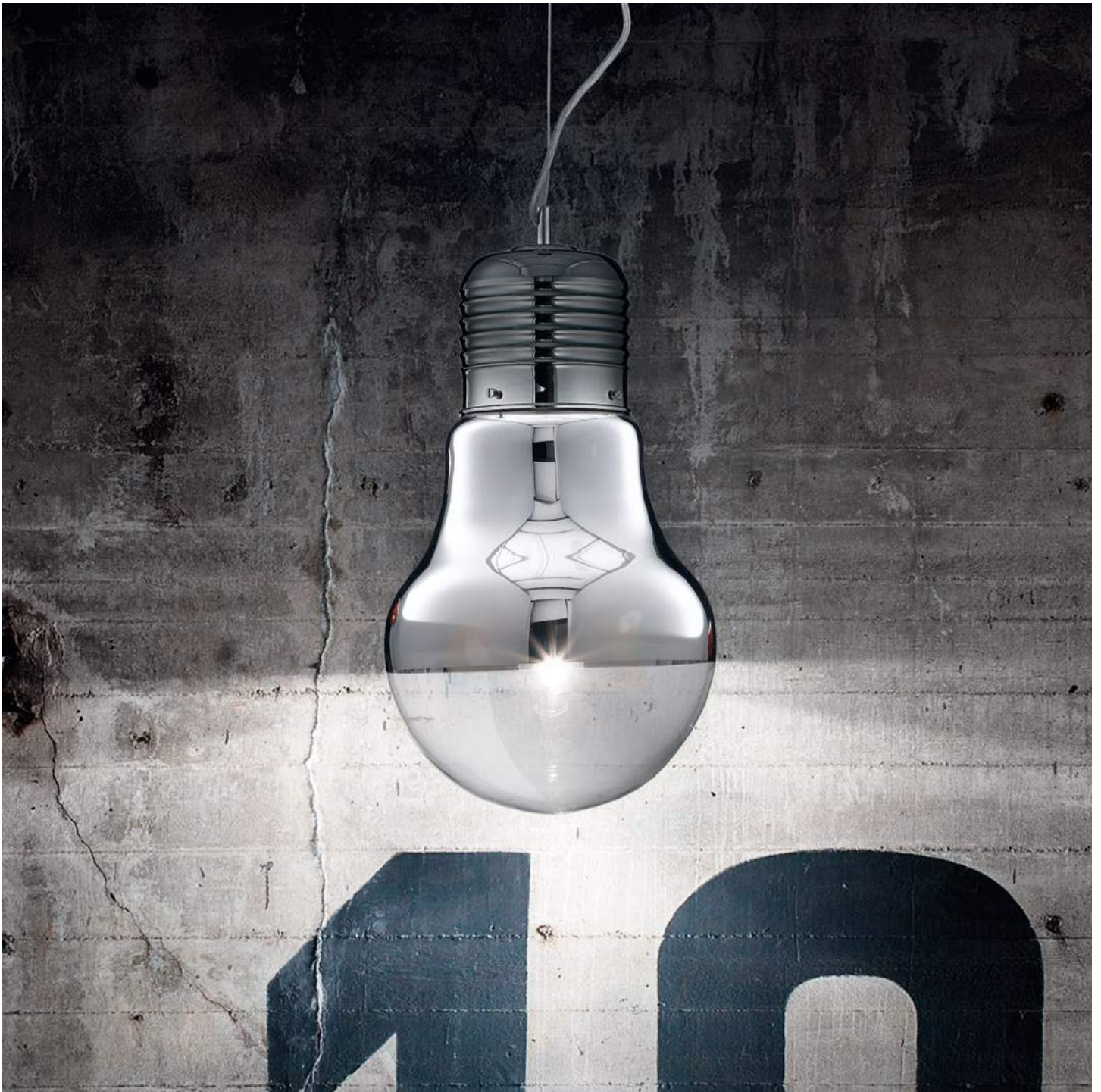

## Luce Cromo

Montatura in cromo. Diffusore in vetro soffiato trasparente e cromato nella parte superiore. Cavo in acciaio a lunghezza regolabile da dispositivo ferma cavo automatico.

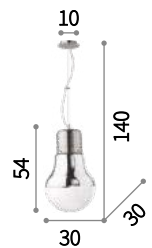

⚡ Ⓢ IP20

E27 max 1x60W

026749 SP1





## Luce Bianco

Montatura in metallo con finitura nickel satinato. Diffusore in vetro bianco soffiato e acidato.

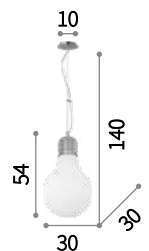

⚗ ⚡ IP20

E27 max 1x60W

006840 SP1





# Luce Max

Montatura in cromo. Diffusore in vetro soffiato con decorazione interna in filo d'alluminio. Sospensioni con cavo in acciaio a lunghezza regolabile da dispositivo ferma cavo automatico.

**ON** Lampada con interruttore integrato nel modello TL1.  
**OFF**

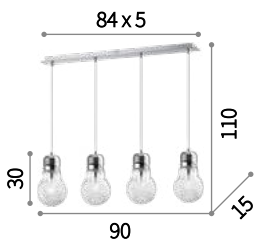

⊖ ⊕ IP20  
E27 max 4 x 60W  
047799 SP4

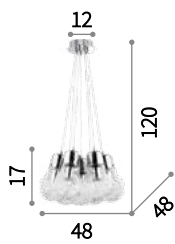

⊖ ⊕ IP20  
E27 max 7 x 60W  
081779 SP7

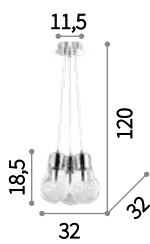

⊖ ⊕ IP20  
E27 max 3 x 60W  
081762 SP3

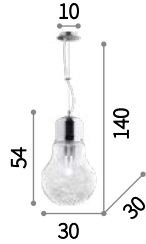

⊖ ⊕ IP20  
E27 max 1 x 60W  
033662 SP1 Big



⊖ ⊕ IP20  
E27 max 1 x 60W  
033679 SP1 Small



⊖ ⊕ IP20  
E27 max 1 x 60W  
033686 TL1





# Mapa Fade

Montatura in metallo cromato. Diffusore a sfera in vetro soffiato trasparente cromato con sfumatura verso il basso.

**ON**  
**OFF** Lampada con interruttore integrato nel modello TL1 D20.

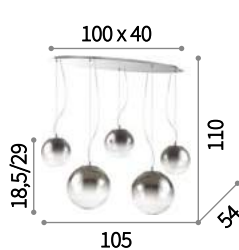

⊕ ⊖ IP20

E27 max 5 x 60W

140759 SP5

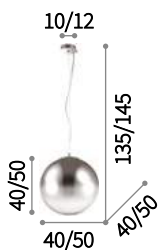

⊕ ⊖ IP20

E27 max 1 x 60W

161334 SP1 D40  
161327 SP1 D50



⊕ ⊖ IP20

E27 max 1 x 60W

140711 SP1 D20  
140728 SP1 D30



⊕ ⊖ ⊕ IP20

E27 max 1 x 60W

186849 AP1 D20  
186856 AP1 D30

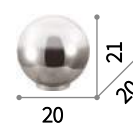

⊕ ⊖ IP20

E27 max 1 x 60W

186863 TL1 D20







# Discovery Fade

Montatura in cromo. Diffusore in vetro soffiato trasparente con rifinitura sfumata in cromo. Sospensioni con cavi in acciaio a lunghezza regolabile da dispositivi ferma cavo automatici.

 Lampadine ALO G9 28W 2700 K incluse nel modello AP2.

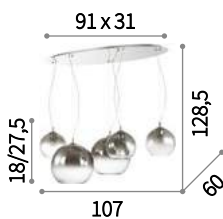

  IP20

E27 max 5 x 60W

138305 SP5

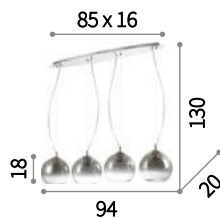

  IP20

E27 max 4 x 60W

149561 SP4

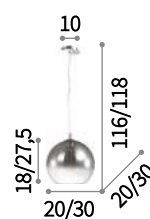

  IP20

E27 max 1 x 60W

149585 SP1 D20  
149592 SP1 D30

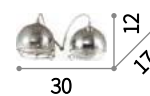

  IP20 

G9 max 2 x 40W

149547 AP2







# Discovery Cromo

Montatura in cromo. Diffusore in vetro soffiato e cromato con banda inferiore trasparente. Sospensioni con cavo in acciaio a lunghezza regolabile da dispositivo ferma cavo automatico.

 Lampadine ALO G9 28W 2700 K incluse nei modelli: PT3, AP1 e AP2.

 Lampada con interruttore integrato nel modello PT3.

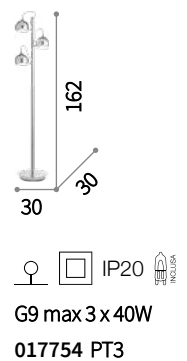
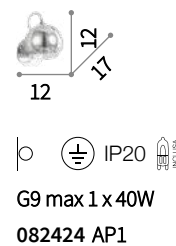
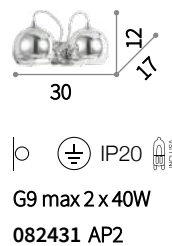
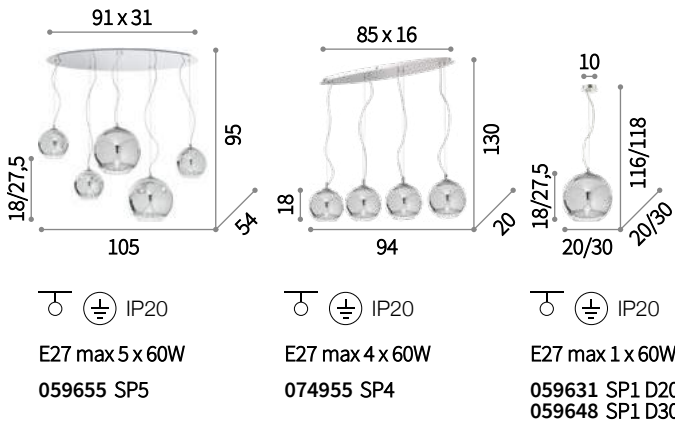





# Nemo Clear

Diffusore in vetro soffiato trasparente.  
Modello D20 con copri lampada in vetro  
bianco soffiato e acidato.



Lampadine ALO G9 28W 2700 K  
includi nel modello SP1 D20.

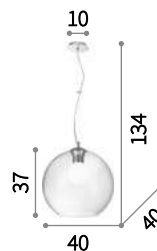

⊕ ⊖ IP20

E27 max 1 x 60W  
052816 SP1 D40

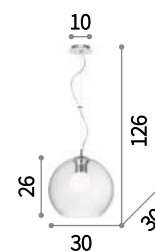

⊕ ⊖ IP20

E27 max 1 x 60W  
052809 SP1 D30

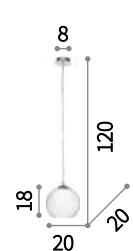

⊕ ⊖ IP20

G9 max 1 x 40W  
052793 SP1 D20





# Nemo

Rosone ed elemento centrale portalampane in metallo. Diffusore in vetro soffiato. Disponibile in varie finiture.

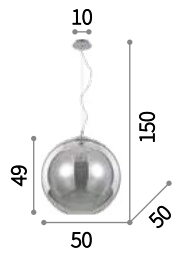

E27 max 1 x 60W

094137 SP1 D50 Fumè



E27 max 1 x 60W

094229 SP1 D40 Fumè  
111919 SP1 D40 Rame

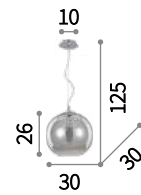

E27 max 1 x 60W

149592 SP1D30CromoSfum.  
094236 SP1D30Fumè  
111902 SP1D30Rame

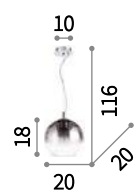

E27 max 1 x 60W

149585 SP1D20CromoSfum.



# Smarties Clear

Montatura in metallo cromato. Diffusore in vetro soffiato trasparente e sabbiato nella zona centrale. Sospensioni con cavi in acciaio a lunghezza regolabile.



Lampadine ALO G9 28W 2700 K incluse nel modello AP1.



IP20  
 E27 max 3 x 60W  
 035505 SP3 D50

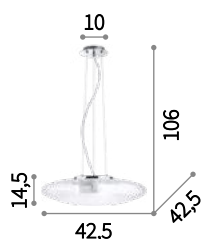

IP20  
 E27 max 3 x 60W  
 035529 SP3 D40

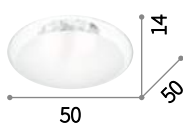

IP20  
 E27 max 3 x 60W  
 035512 PL3 D50

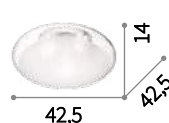

IP20  
 E27 max 2 x 60W  
 035536 PL2 D40

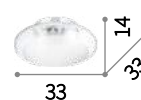

IP20  
 E27 max 1 x 60W  
 035543 PL1 D33

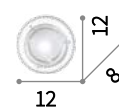

IP20
 

  
 G9 max 1 x 40W  
 035567 AP1







173023

# Yoga

Montatura in metallo rifinito con vernice opaca. Diffusori in vetro soffiato completamente trasparente o trasparente satinato.



Lampadine ALO G9 28W 2700 K incluse.



172996

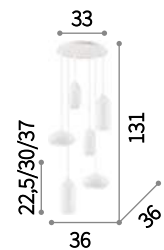

G9 max 6 x 40W

173016 SP6 Bianco  
173023 SP6 Nero

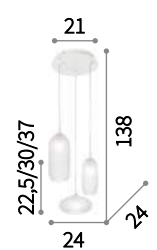

G9 max 3 x 40W

172996 SP3 Bianco  
173009 SP3 Nero



088938



088921



088969

# Zeno

Montatura in metallo cromato. Diffusore in vetro soffiato trasparente e colorato. Cavo elettrico regolabile in lunghezza.

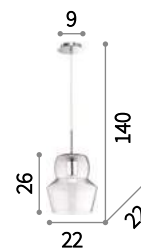

⊕ ⊖ IP20

E27 max 1 x 60W

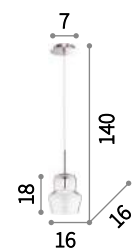

⊕ ⊖ IP20

E14 max 1 x 40W

- |                            |                              |
|----------------------------|------------------------------|
| 088969 SP1 Big Azzurro     | 036120 SP1 Small Azzurro     |
| 088938 SP1 Big Fumè        | 002040 SP1 Small Fumè        |
| 088921 SP1 Big Trasparente | 003108 SP1 Small Trasparente |



# Cognac

Rosone e montatura in metallo verniciato nero opaco. Diffusore in vetro soffiato trasparente con decoro in rilievo.

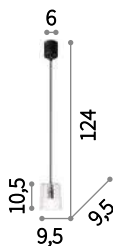

G9 max 1 x 15W  
166988 Cognac-1 SP1

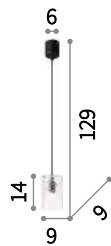

G9 max 1 x 15W  
167015 Cognac-2 SP1

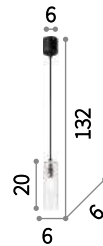

G9 max 1 x 15W  
167107 Cognac-3 SP1

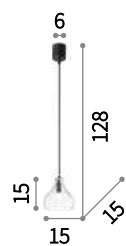

G9 max 1 x 15W  
167022 Cognac-4 SP1







# Lido

Montatura in metallo verniciato opaco.  
Cavo in tessuto. Diffusori in vetro soffiato  
bianco acidato o trasparente fumè.

**LED** Lampadine LED G9 3,2W 3000 K  
incluse. Cod. 209043

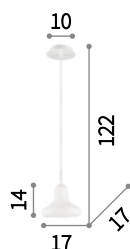

G9 max 1 x 15W

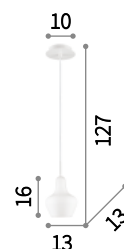

G9 max 1 x 15W

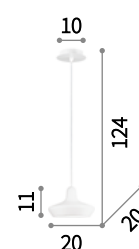

G9 max 1 x 15W

167626 Lido-1 SP1 Bianco 167640 Lido-2 SP1 Bianco 168319 Lido-3 SP1 Bianco  
168326 Lido-1 SP1 Fumè 168357 Lido-2 SP1 Fumè 168364 Lido-3 SP1 Fumè



168326





# Soft

Montatura in metallo con varie finiture.  
Diffusori in vetro soffiato bianco o fumè  
oppure in cemento.



⊕ ⊖ IP20

E14 max 6 x 40W

087818 SP6 Bianco  
111841 SP6 Fumè

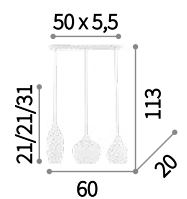

⊕ ⊖ IP20

E14 max 3 x 40W

111858 SP3 Bianco  
179766 SP3 Cemento  
111865 SP3 Fumè



111841



# Cocktail

Diffusore in vetro soffiato incamiciato e acidato. Bianco all'interno e colorato all'esterno. Sospensioni con cavi a lunghezza regolabile.

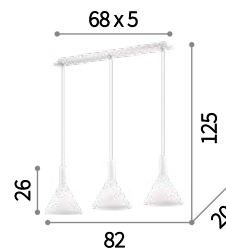

⊕ ⊖ IP20

E14 max 3 x 40W  
074245 SP3 Bianco

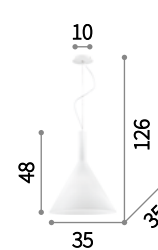

⊕ ⊖ IP20

E27 max 1 x 60W  
074313 SP1 Big Bianco



⊕ ⊖ IP20

E14 max 1 x 40W  
074337 SP1 Small Bianco  
074344 SP1 Small Nero





# Manhattan

Rosone e diffusore in metallo rifinito con vernice opaca bianca o nera e con dettaglio in legno naturale. Cavo in tessuto.

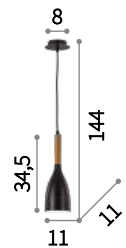

⊕ ⊖ IP20

E14 max 1x40W

110745 SP1 Bianco  
110752 SP1 Nero



012919

# Olimpia

Montatura in cromo. Diffusore in vetro colorato soffiato e incamiciato. Cavo elettrico regolabile in lunghezza.



013244

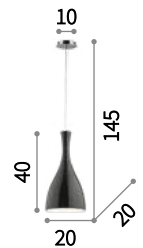

⊕ ⊖ IP20

E27 max 1x60W

013244 SP1 Bianco  
012919 SP1 Nero



# Flut

Diffusore in vetro soffiato incamiciato e acidato, bianco all'interno e colorato all'esterno. Cavo a lunghezza regolabile.

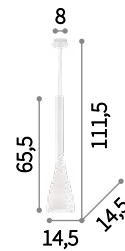

⊕ ⊖ IP20

E27 max 1 x 60W

035666 SP1 Big Bianco  
035680 SP1 Big Nero  
035673 SP1 Big Rosso

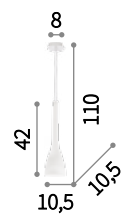

⊕ ⊖ IP20

E14 max 1 x 40W

035697 SP1 Small Bianco  
035710 SP1 Small Nero  
035703 SP1 Small Rosso







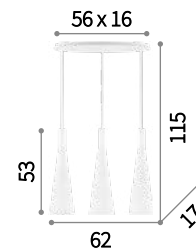

# Milk

Base ellittica in metallo smaltato bianco. Diffusore in vetro bianco soffiato e acidato. Cavi elettrici regolabili in lunghezza.

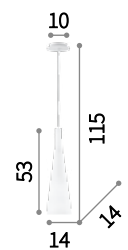

 IP20  
 E27 max 3 x 60W  
 030326 SP3



 IP20  
 E27 max 1 x 60W  
 026787 SP1



# Elica

Montatura in nickel satinato. Diffusore in vetro bianco soffiato, incamiciato e acidato. Sospensioni con cavo in acciaio a lunghezza regolabile con dispositivo ferma cavo automatico.

 Lampadine ALO G9 28W 2700 K incluse nel modello AP2.

 Lampada con interruttore integrato nei modelli: TL1 e PT1.

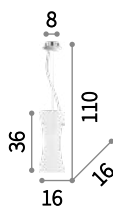

  IP20

E27 max 1 x 60W  
017600 SP1

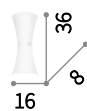

  IP20 

G9 max 2 x 40W  
017617 AP2

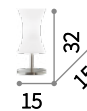

  IP20

E14 max 1 x 40W  
014593 TL1



  IP20

E27 max 1 x 60W  
017587 PT1



# Lena

Montatura in metallo cromato. Diffusore con doppio vetro: smerigliato e colorato quello esterno, bianco quello interno. Sospensioni con cavi in acciaio a lunghezza regolabile da dispositivi automatici.

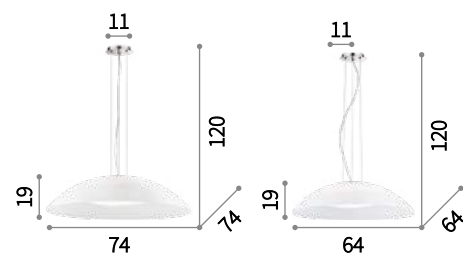

⊕ ⊖ IP20

E27 max 3 x 60W

052786 SP3 D74 Bianco

⊕ ⊖ IP20

E27 max 3 x 60W

035727 SP3 D64 Bianco  
066592 SP3 D64 Grigio  
066608 SP3 D64 Marrone



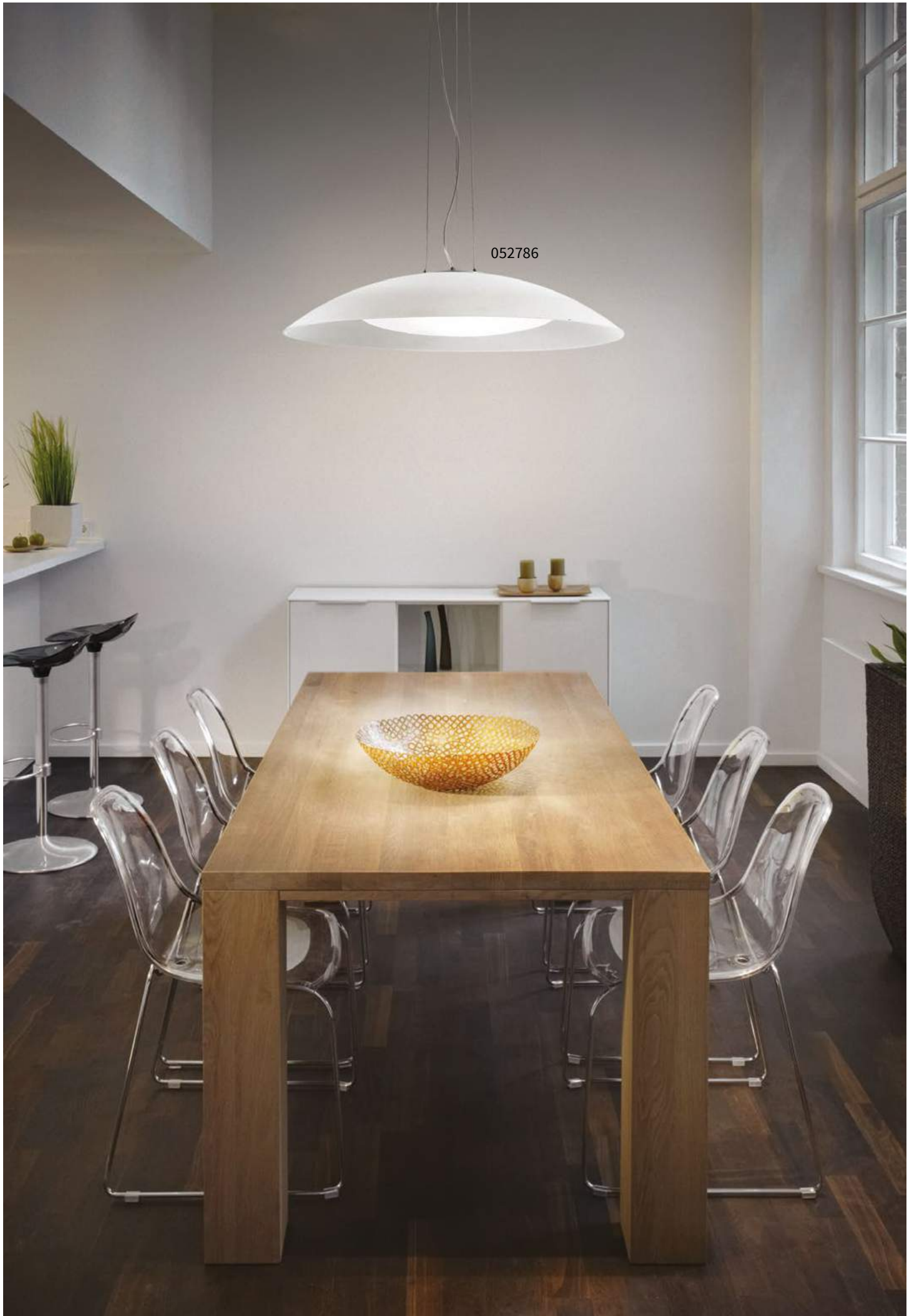

052786







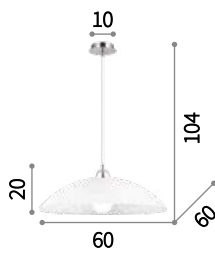

# Lana

Diffusore in vetro trasparente con decorazioni serigrafate all'interno e sabbiato all'esterno. Ganci ferma vetro in metallo cromato.



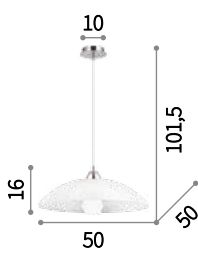



 IP20  
 E27 max 1x60W  
 068176 SP1 D60

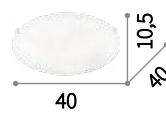





 IP20  
 E27 max 1x60W  
 068169 SP1 D50









 IP20  
 E27 max 3x60W  
 068145 PL3

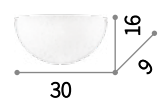



 IP20  
 E27 max 2x60W  
 068138 PL2



 IP20  
 E27 max 1x60W  
 068121 AP1







# Aria

Diffusore in vetro bianco soffiato e acidato.  
Cavi in acciaio a lunghezza regolabile con  
dispositivi ferma cavo automatici.

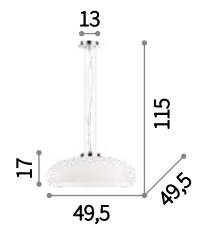

⊕ ⊕ IP20

E27 max 1x60W

059679 SP1 D50



# Mama

Montatura e anello sul bordo inferiore in metallo rifinito con smalto bianco satinato. Diffusore in vetro bianco soffiato e acidato. Cavi in acciaio a lunghezza regolabile da dispositivi automatici.

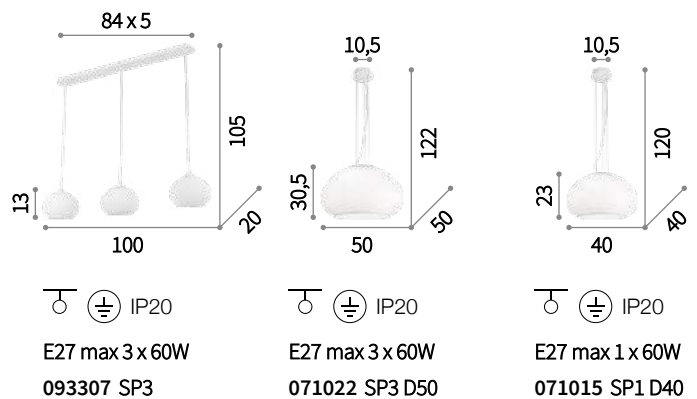



137315

# Aladino

Montatura in metallo smaltato bianco satinato. Diffusore in vetro soffiato incamiciato: acidato il bianco, lucido l'azzurro. Cavi in acciaio a lunghezza regolabile da dispositivi automatici.

**ON** Lampada con interruttore integrato nel modello TL3.  
**OFF**



⊕ ⊖ IP20

E27 max 1 x 60W

137261 SP1 D45 Azzurro  
137308 SP1 D45 Bianco

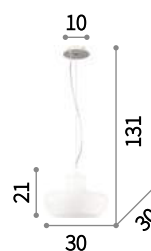

⊕ ⊖ IP20

E27 max 1 x 60W

137292 SP1 D30 Azzurro  
137315 SP1 D30 Bianco



⊕ ⊖ IP20

G9 max 3 x 40W

137285 TL3 Bianco





137261



# Eva

Montatura in metallo cromato. Diffusore in vetro soffiato. Disponibile in vetro bianco incamiciato e acidato o trasparente con effetto fumè. Cavi in acciaio a lunghezza regolabile da dispositivi automatici.

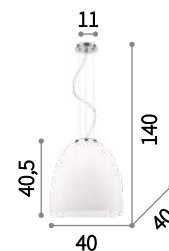

⊕ ⊖ IP20

E27 max 1 x 60W

077703 SP1 Big Bianco  
101095 SP1 Big Fumè



⊕ ⊖ IP20

E27 max 1 x 60W

077697 SP1 Small Bianco  
101101 SP1 Small Fumè



# Tolomeo

Diffusore in vetro soffiato, incamiciato e decorato a mano. Cavi in acciaio a lunghezza regolabile con dispositivi ferma cavo automatici.

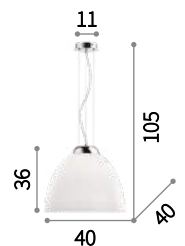

⊕ ⊖ IP20

E27 max 1x100W

001814 SP1 Bianco  
001821 SP1 Grigio



# Etna

Montatura in metallo con finitura nickel satinato. Diffusore in vetro bianco soffiato e acidato.

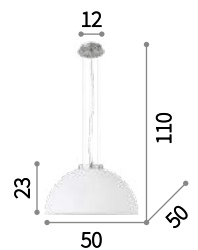

⊕ ⊖ IP20

E27 max 1x100W

027906 SP1









# Don

Montatura e diffusore in metallo rifinito con vernice bianca opaca all'esterno e lucida all'interno.

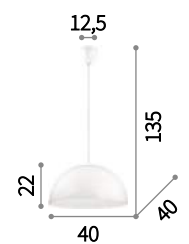

 IP20  
 E27 max 1 x 60W  
 103136 SP1 Big



 IP20  
 E27 max 1 x 60W  
 103112 SP1 Small

# Cylinder

Montatura in metallo. Diffusore in vetro soffiato bianco acidato. Cavi in acciaio a lunghezza regolabile con dispositivi ferma cavo automatici.

 Lampada con interruttore integrato nel modello PT2.



  IP20

E27 max 1 x 100W  
025438 SP1 D40



  IP20

E27 max 1 x 100W  
025421 SP1 D30

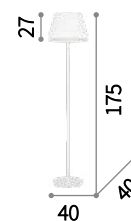

  IP20

E27 max 2 x 60W  
111452 PT2





# Compo

Montatura in metallo verniciato bianco opaco. Elementi diffusori in vetro soffiato bianco incamiciato e acidato o trasparente fumè.

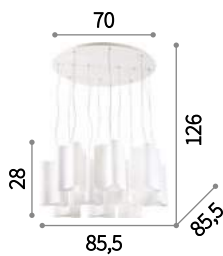

⊕ ⊖ IP20

E27 max 10 x 60W  
208053 SP10 Bianco

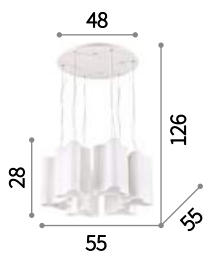

⊕ ⊖ IP20

E27 max 6 x 60W  
208046 SP6 Bianco

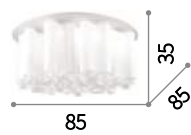

⊕ ⊖ IP20

E27 max 15 x 60W  
125565 PL15 Bianco

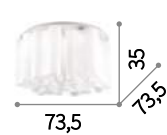

⊕ ⊖ IP20

E27 max 10 x 60W  
125510 PL10 Bianco  
172804 PL10 Fumè

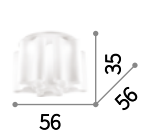

⊕ ⊖ IP20

E27 max 6 x 60W  
125503 PL6 Bianco  
172828 PL6 Fumè







125510



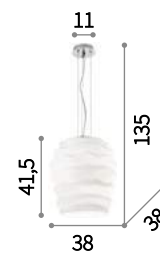

# Karma

Montatura in metallo cromato. Diffusore in vetro soffiato bianco incamiciato e acidato. Cavi in acciaio a lunghezza regolabile da dispositivi ferma cavo automatici.



 IP20  
 E27 max 1 x 60W  
 132365 SP1 Big



 IP20  
 E27 max 1 x 60W  
 132389 SP1 Small





# Origami

Montatura in metallo verniciato opaco.  
Diffusori in vetro bianco soffiato e acidato  
con effetto piegature in rilievo.



⊕ ⊖ IP20

E27 max 3 x 60W  
198095 SP3



⊕ ⊖ IP20

E27 max 1 x 60W  
200583 Origami-1 SP1

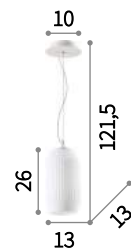

⊕ ⊖ IP20

E27 max 1 x 60W  
200590 Origami-2 SP1



⊕ ⊖ IP20

E27 max 1 x 60W  
200606 Origami-3 SP1







# Diamond

Montatura in metallo cromato. Diffusore in vetro bianco soffiato e acidato. Sospensioni con cavi in acciaio a lunghezza regolabile con dispositivi ferma cavo automatici.

**ON** Lampada con interruttore integrato nel modello TL1.  
**OFF**

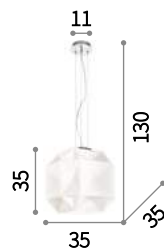

⊕ ⊖ IP20  
E27 max 1x60W  
022499 SP1 Big

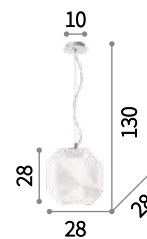

⊕ ⊖ IP20  
E27 max 1x60W  
022505 SP1 Medium

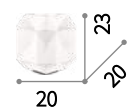

⊕ ⊖ IP20  
E27 max 1x60W  
036076 TL1



# Ovalino

Diffusore composto da elementi circolari in lastra di vetro curvata e acidata. Cavi in acciaio regolabili in lunghezza da dispositivi automatici.

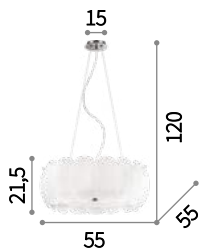

⊕ ⊖ IP20

E27 max 8 x 60W  
090481 SP8



⊕ ⊖ IP20

E27 max 5 x 60W  
074139 SP5

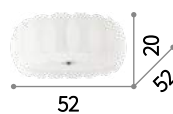

⊕ ⊖ IP20

E27 max 8 x 60W  
094014 PL8

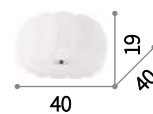

⊕ ⊖ IP20

E27 max 5 x 60W  
093963 PL5

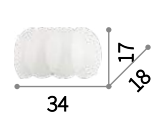

⊕ ⊖ IP20

E27 max 2 x 60W  
038025 AP2



# Cairo

Montatura in metallo veniciato opaco.  
 Diffusori in vetro bianco soffiato e acidato.  
 Sospensione grande con cavo d'acciaio.



⊕ ⊖ IP20

E27 max 4 x 60W  
 208183 SP4 D15



⊕ ⊖ IP20

E27 max 1 x 60W  
 208169 SP1 D40



⊕ ⊖ IP20

E27 max 1 x 60W  
 208176 SP1 D15





# Sesto

Montatura in metallo cromato. Diffusore in vetro soffiato bianco e acidato. Cavi in acciaio a lunghezza regolabile con dispositivi ferma cavo automatici.

**ON** Lampada con interruttore integrato nel modello PT2.  
**OFF**

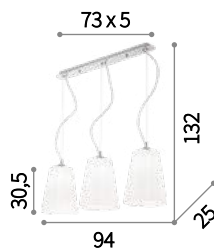

⊕ ⊖ IP20  
E27 max 3 x 60W  
132204 SP3



⊕ ⊖ IP20  
E27 max 1 x 60W  
115740 SP1 D35



⊕ ⊖ IP20  
E27 max 1 x 60W  
132228 SP1 D25

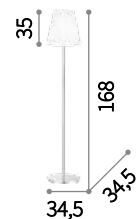

⊕ ⊖ IP20  
E27 max 2 x 60W  
125480 PT2



# Smarties Bianco

Montatura in metallo. Diffusore in vetro bianco soffiato e acidato. Per le sospensioni, cavi in acciaio a lunghezza regolabile con dispositivi ferma cavo automatici.

 Lampadine ALO G9 28W 2700 K incluse nei modelli: AP1 e TL1.

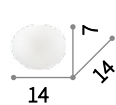
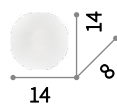
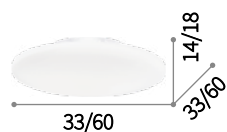
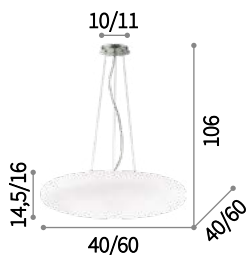

 Lampada con interruttore integrato nel modello TL1.



  IP20

E27 max 3 / 3 / 5 x 60W

032016 SP3 D40  
032009 SP3 D50  
031996 SP5 D60

   IP20

E27 max 1 / 2 / 3 / 3 x 60W

009223 PL1 D33  
032047 PL2 D40  
032030 PL3 D50  
032023 PL3 D60

    IP20 

G9 max 1 x 40W

014814 AP1

  IP20 

G9 max 1 x 40W

032078 TL1









# Glory

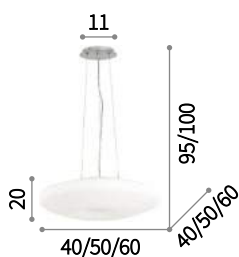

Montatura rifinita in nickel satinato.  
 Diffusore in vetro bianco soffiato e acidato. Sospensioni con cavi in acciaio regolabili in lunghezza con dispositivi automatici.

 Lampadine ALO G9 28W 2700 K incluse nel modello PL1 D30.



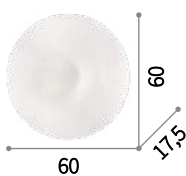

  IP20  
 E27 max 3 / 3 / 5 x 60W  
 101125 SP3 D40  
 019734 SP3 D50  
 019741 SP5 D60



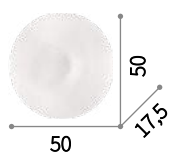

  IP20  
 E27 max 5 x 60W  
 019765 PL5 D60



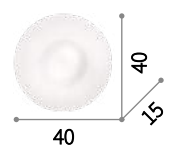



  IP20  
 E27 max 3 x 60W  
 019758 PL3 D50

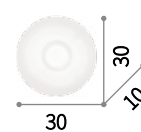

  IP20  
 E27 max 2 x 60W  
 101132 PL2 D40



   IP20   
 G9 max 1 x 40W  
 101149 PL1 D30







# Arizona

Montatura in metallo rifinito in ottone satinato. Diffusore in vetro bianco soffiato, acidato e con rigature decorative in rilievo.

**LED** Lampadine LED GX53 9,5W 3000 K incluse. Cod. 123936

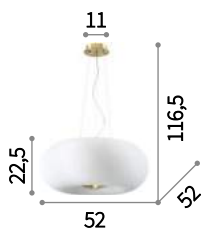

IP20
 
 GX53 max 5 x 15W  
 214481 SP5



IP20
 
 GX53 max 3 x 15W  
 214474 SP3

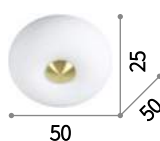

IP20
 
 GX53 max 5 x 15W  
 214511 PL5

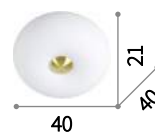

IP20
 
 GX53 max 3 x 15W  
 214504 PL3

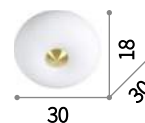

IP20
 
 GX53 max 2 x 15W  
 214498 PL2





# Ulisse

Montatura in metallo verniciato bianco opaco. Diffusore in vetro bianco soffiato e acidato. Sospensioni con cavi in acciaio a lunghezza regolabile da dispositivi automatici.

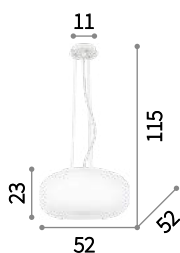

IP20  
E27 max 3 x 60W  
098616 SP3 D52



IP20  
E27 max 3 x 60W  
095226 SP3 D42

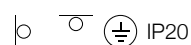
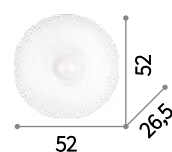

IP20  
E27 max 3 x 60W  
098586 PL3 D52

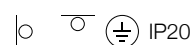
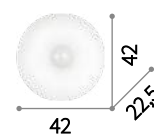

IP20  
E27 max 3 x 60W  
095196 PL3 D42







# Candy

Montatura in metallo con finitura nickel satinato. Diffusore in vetro bianco soffiato e acidato. Cavi in acciaio a lunghezza regolabile con dispositivi ferma cavo automatici.



Lampadine ALO G9 28W 2700 K incluse nei modelli: SP1 D25, TL1 D25 e TL1 D14.



Lampada con interruttore integrato nei modelli: TL1 D25 e TL1 D14.

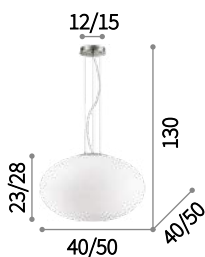

⊕ ⊖ IP20

E27 max 1x60W  
086736 SP1 D40  
086743 SP1 D50

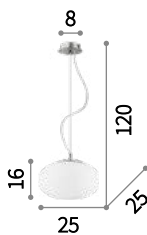

⊕ ⊖ IP20 

G9 max 1x40W  
086729 SP1 D25

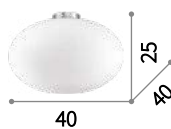

⊕ ⊖ ⊕ IP20

E27 max 1x60W  
086781 PL1 D40

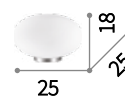

⊕ ⊖ IP20 

G9 max 1x40W  
086804 TL1 D25

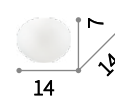

⊕ ⊖ IP20 

G9 max 1x40W  
032078 TL1





# Palladio

Montatura in metallo smaltato bianco satinato. Diffusore in vetro soffiato bianco, acidato. Cavo in acciaio a lunghezza regolabile da dispositivo automatico.

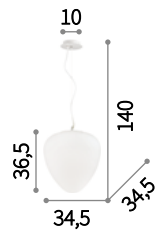

⊕ ⊖ IP20

E27 max 1x60W

132013 SP1 D35





# Boa

Montatura in metallo verniciato opaco.  
 Cavo in tessuto da 12 metri con 6 supporti.  
 Diffusore in vetro soffiato bianco acidato.

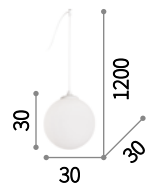

⊕ ⊖ IP20

E27 max 1x60W

160863 SP1 Bianco  
 160856 SP1 Nero



# Mapa Riga

Montatura in metallo. Diffusore in vetro soffiato bianco con decorazione dipinta.

**ON**  
**OFF** Lampada con interruttore integrato nel modello TL1 D20.

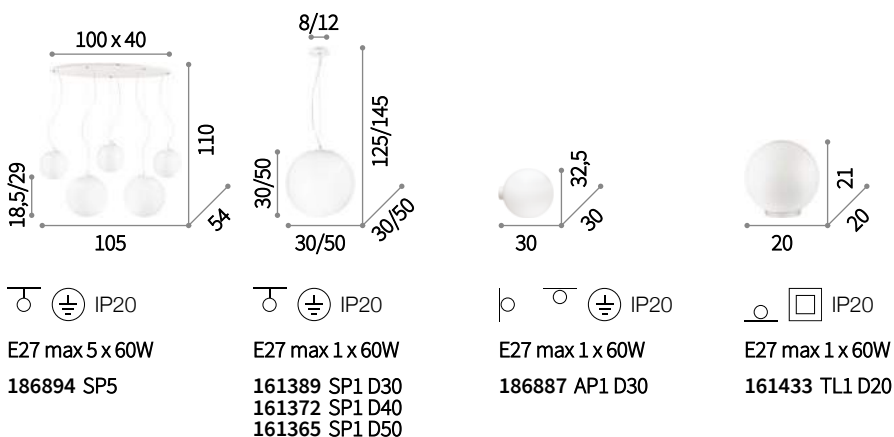





# Mapa Bianco

Montatura in metallo. Diffusore a sfera in vetro bianco soffiato e acidato. Sospensioni con cavi in acciaio a lunghezza regolabile.



Lampadine ALO G9 28W 2700 K incluse nel modello AP1 D15.



Lampada con interruttore integrato nei modelli: TL1 D20, TL1 D30 e TL1 D40.



IP20

E14 max 11 / 22 x 40W

131924 SP11  
140230 SP22

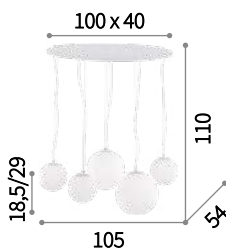

IP20

E27 max 5 x 60W

043562 SP5



IP20

E27 max 1 x 60W

009148 SP1 D20 ø 20 cm  
009087 SP1 D30 ø 30 cm  
032139 SP1 D40 ø 40 cm  
032122 SP1 D50 ø 50 cm



IP20

E27 max 1 x 60W

059815 AP1 D20  
059822 AP1 D30  
059839 PL1 D40

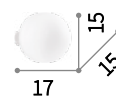

IP20

G9 max 1 x 40W

059808 AP1 D15

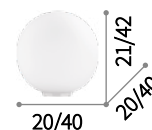

IP20

E27 max 1 x 60W

009155 TL1 D20  
009131 TL1 D30  
000206 TL1 D40







# Penombra

Montatura e vela superiore in metallo rifinito in ottone o in cromo. Diffusore in vetro bianco soffiato e acidato.

**ON**  
**OFF** Lampada con interruttore integrato nel modello TL1.



⊕ ⊖ IP20

E27 max 1x60W

176642 SP1 Cromo  
176734 SP1 Ottone

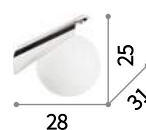

⊕ ⊖ IP20

E27 max 1x60W

176598 AP1 Cromo  
176666 AP1 Ottone



⊕ ⊖ IP20

E27 max 1x60W

176611 TL1 Cromo  
176680 TL1 Ottone

176734





# Cin Cin

Rosone e montatura in metallo cromato.  
 Diffusori in vetro soffiato trasparente con  
 decorazione interna in filo d'alluminio.  
 Sospensioni con cavi regolabili in  
 lunghezza.



Lampadine ALO G4 20W 2700 K  
 incluse.

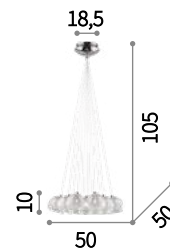

IP20   
 G4 max 11 x 20W  
 060224 SP11

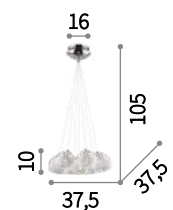

IP20   
 G4 max 7 x 20W  
 060231 SP7





# Emis

Montatura centrale in nickel satinato.  
Diffusore a sfera avvolto da filamento  
d'alluminio con perle di cristallo molato.



Lampadine ALO G9 28W 2700 K  
incluse nel modello TL1 D16.



Lampada con interruttore integrato  
nel modello TL1 D16.

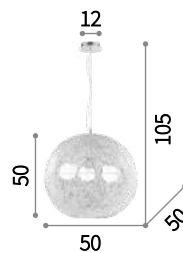

IP20

E27 max 3 x 60W

026510 SP3 D50



IP20

E27 max 1 x 60W

022420 SP1 D40

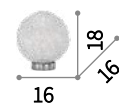

IP20

G9 max 1 x 40W

013756 TL1 D16

# Croisette

Montatura in metallo verniciato. Schermo diffusore in materiale acrilico. Cavi d'acciaio regolabili in lunghezza. Led integrato.

**LED** Sorgente luminosa LED 4000 K, 17.500 h di durata.

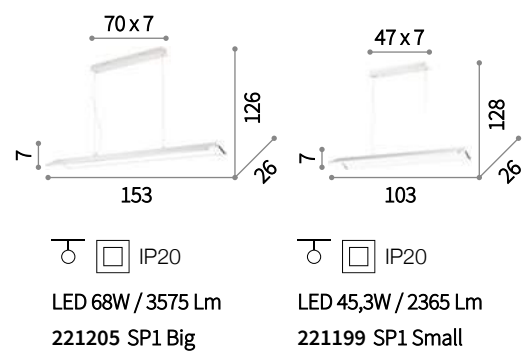





# Superior

Montatura in metallo cromato. Elemento decorativo in lastra di vetro molato trasparente. Diffusore in vetro serigrafato bianco.

**LED** Lampadine LED GX53 9,5W 3000 K incluse. Cod. 123936

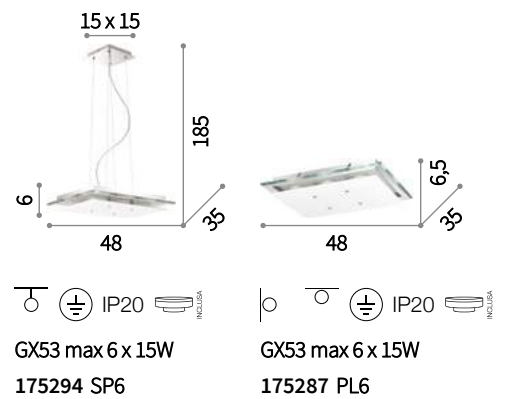





# Pacific

Montatura in metallo cromato. Diffusore con doppia lastra di vetro molato: trasparente la prima, sabbiata quella più esterna.

**LED** Sorgente luminosa LED 3000 K, 20.000 h di durata.



⌀ ⌀ Ⓧ IP20

LED 18W / 1170 Lm

074221 PL18



# Concorde

Montatura in metallo con finitura in vernice opaca. Elemento decorativo in vetro trasparente.

**LED** Lampadine LED GX53 9,5W 3000 K incluse. Cod. 123936

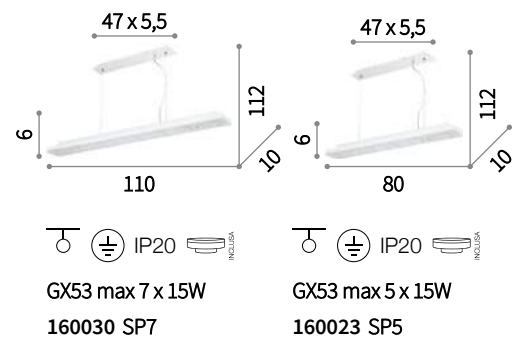



# Shots

Montatura in metallo rifinito opaco, cavi in tessuto, snodi cromati. Diffusori orientabili con elementi in acrilico satinato.

**LED** Sorgente luminosa LED 3000 K, 30.000 h di durata.

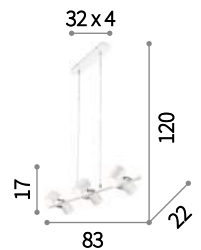

⊕ ⊖ IP20

LED 30W / 2400 Lm

186825 SP6 Bianco  
179612 SP6 Nero



# Madame

Rosone in metallo verniciato opaco. Cavo in tessuto. Diffusore con telaio metallico avvolto da nastro in tessuto di raso.

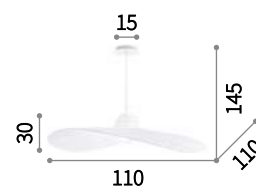

⊕ ⊖ IP20

E27 max 1x60W

219875 SP1 Avorio  
 174396 SP1 Bianco  
 174402 SP1 Nero





174402





# Basket

Montatura in metallo cromato. Diffusore in spago ignifugo. Sospensione a sfera con cavo in acciaio regolabile in lunghezza da dispositivo automatico.

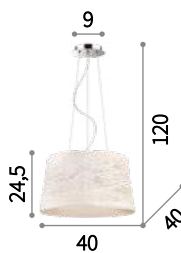

 Lampadine ALO G9 28W 2700 K incluse nel modello AP1.

 Lampada con interruttore integrato nei modelli: TL1 e PT1.





  IP20  
E27 max 3 x 60W  
082509 SP3



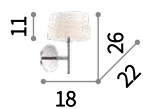

  IP20  
E27 max 1 x 60W  
096100 SP1 D30  
096162 SP1 D40





  IP20   
G9 max 1 x 40W  
082493 AP1



  IP20  
E27 max 1 x 60W  
082387 TL1



  IP20  
E27 max 1 x 60W  
082448 PT1







201092

# Luxury

Montatura in metallo. Base nera opaca.  
Paralume in pvc con bordi in tessuto.

**ON**  
**OFF** Lampada con interruttore integrato nei modelli: TL1 e PT1.

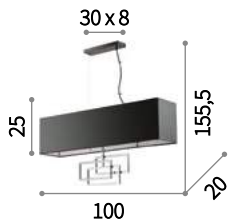

E14 max 6 x 40W  
219721 SP6 Cromo  
219738 SP6 Ottone

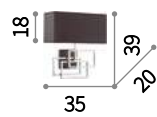

E27 max 1 x 60W  
201054 AP1 Cromo  
201092 AP1 Ottone

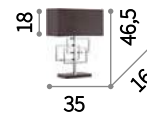

E14 max 1 x 60W  
201078 TL1 Cromo  
201115 TL1 Ottone

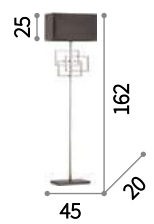

E27 max 1 x 60W  
201085 PT1 Cromo  
201122 PT1 Ottone





219721



099118

# Phoenix

Montatura in metallo cromato. Paralume con telaio in metallo e rivestimento in tessuto. Elementi decorativi con catene di ottagoni in cristallo molato. Sospensioni con cavi in acciaio regolabili in lunghezza da dispositivi automatici.

**ON** Lampada con interruttore integrato  
**OFF** nel modello PT1.

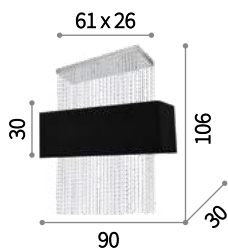
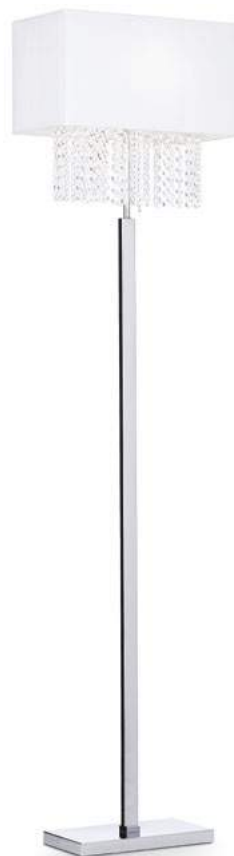

⊕ ⊖ IP20

E27 max 5 x 60W

099101 SP5 Bianco  
101163 SP5 Nero



⊕ ⊖ IP20

E27 max 5 x 60W

099118 PL5 Bianco  
101156 PL5 Nero

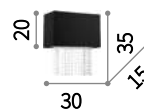

⊕ ⊖ IP20

E14 max 2 x 40W

115696 AP2 Bianco  
113715 AP2 Nero



⊕ ⊖ IP20

E27 max 1 x 60W

115719 PT1 Bianco  
113692 PT1 Nero



101163

# London Cromo

Montatura in metallo cromato. Paralume in lamina di PVC cromata e semi trasparente. Per la sospensione, cavi in acciaio a lunghezza regolabile con dispositivi ferma cavo automatici.

**ON** Lampada con interruttore integrato  
**OFF** nei modelli: TL1 Big, TL1 Small e PT1.

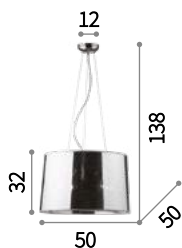

⊕ ⊖ IP20

E27 max 5 x 60W

032351 SP5



⊕ ⊖ IP20

E27 max 1 x 60W

032375 TL1 Big



⊕ ⊖ IP20

E27 max 1 x 60W

032368 TL1 Small

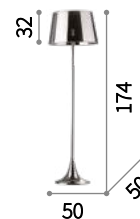

⊕ ⊖ IP20

E27 max 1 x 100W

032382 PT1







# Effetti

Montatura in metallo verniciato bianco opaco. Paralume in nastro di tessuto. Sospensioni con cavi in acciaio regolabili in lunghezza da dispositivi automatici. Applique con controllo indipendente delle due sorgenti luminose.

**LED** Sorgente luminosa LED 3000 K nel modello AP2, 15.000 h di durata.

**ON/OFF** Lampada con interruttore integrato nei modelli: AP2, TL1 e PT1.



⊕ ⊖ IP20

E27 max 5 x 60W  
132945 SP5

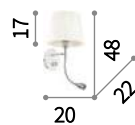

⊕ ⊖ IP20

E14 max 1 x 40W +  
LED 1W / 72 Lm  
132976 AP2



⊕ ⊖ IP20

E27 max 1 x 60W  
132952 TL1

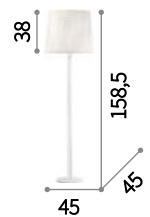

⊕ ⊖ IP20

E27 max 1 x 60W  
132969 PT1



# Ekos

Montatura in metallo con finitura bianco opaco. Paralumi in lamina di PVC rivestita di tessuto canvas.



Lampadine ALO G9 28W 2700 K incluse.

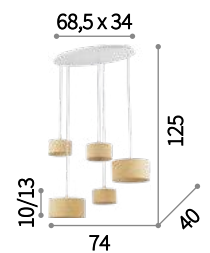

⊕ IP20 RECYCLING

G9 max 5 x 40W

110868 SP5



# Smug

Rosone in metallo cromato. Paralume in tessuto d'organza con riflessi brillanti. Sospensione con cavi in acciaio a lunghezza regolabile.

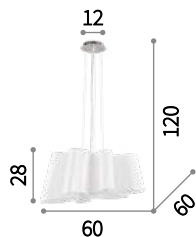

⊕ IP20

E27 max 1 x 60W

110684 SP1



# Nastrino

Montatura in metallo cromato. Paralumi con telaio in metallo smaltato bianco avvolto da nastro in tessuto d'organza bianco.



Lampadine ALO G9 28W 2700 K incluse.

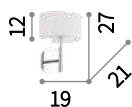
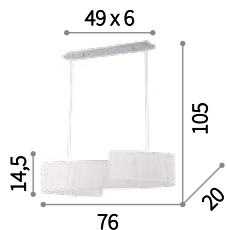

⊕ IP20 

G9 max 4 x 40W

088631 SP4

⊕ IP20 

G9 max 1 x 40W

092577 AP1









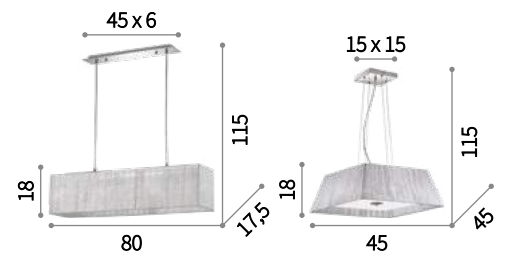

# Missouri

Montatura in cromo. Paralumi in tessuto d'organza con riflessi metallizzati. Sospensioni con cavi in acciaio a lunghezza regolabile. Quella quadrata con fondo chiuso da vetro acidato.



 IP20  
 E14 max 6 x 40W  
 035925 SP6

 IP20  
 E27 max 4 x 60W  
 035932 SP4



# Foil

Rosone in materiale plastico. Cavo in tessuto. Paralume in lamina di pvc rifinito con effetto metallico.



⊕ □ IP20

E27 max 1x60W

168234 SP1 Alluminio  
157719 SP1 Rame





# Woody

Montatura in metallo cromato. Diffusore in PVC o in tessuto, chiuso sul fondo da vetro trasparente acidato. Sospensioni con cavi regolabili in lunghezza.

 Lampadine ALO G9 28W 2700 K incluse nei modelli: AP1 e TL1.

 Lampada con interruttore integrato nei modelli: TL1 e PT2.

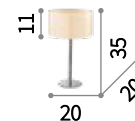
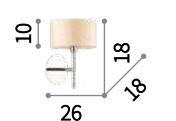
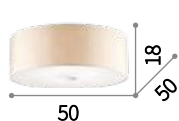
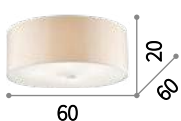
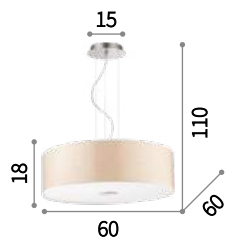

  IP20

E27 max 5 x 60W

103242 SP5 Bianco  
105628 SP5 Nero  
087719 SP5 Wood

  IP20

E27 max 4 x 60W

122236 SP4 Bianco  
122243 SP4 Nero  
087702 SP4 Wood

   IP20

E27 max 5 x 60W

122205 PL5 Bianco  
122212 PL5 Nero  
090863 PL5 Wood

   IP20

E27 max 4 x 60W

103266 PL4 Bianco  
103273 PL4 Nero  
090900 PL4 Wood

  IP20 

G9 max 1 x 40W

143156 AP1 Bianco  
087665 AP1 Wood

  IP20 

G9 max 1 x 40W

143187 TL1 Bianco  
087672 TL1 Wood



105628



103242

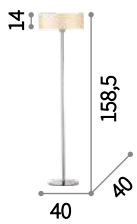

♀ □ IP20

E14 max 2 x 40W

143163 PT2 Bianco  
087689 PT2 Wood



# Nordik

Montatura in metallo verniciato nero opaco. Paralume in lamina di PVC dorato rivestito in tessuto nero.

**LED** Sorgente luminosa LED 3000 K nel modello AP2, 15.000 h di durata.

**ON OFF** Lampada con interruttore integrato nei modelli: AP2, TL1 e PT1.



⊕ ⊖ IP20  
E27 max 6 x 60W  
161662 SP6



⊕ ⊖ IP20  
E27 max 4 x 60W  
161648 SP4

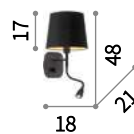

⊕ ⊖ IP20  
E14 max 1 x 40W +  
LED 1W / 45 Lm  
158242 AP2

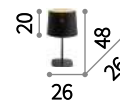

⊕ ⊖ IP20  
E27 max 1 x 60W  
161686 TL1

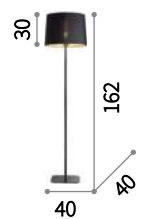

⊕ ⊖ IP20  
E27 max 1 x 60W  
161716 PT1





# Ritz

Base in metallo smaltato. Paralume e pannello diffusore inferiore in lamina di PVC rivestita di tessuto.

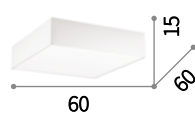

⊕ IP20

E27 max 4 x 60W  
152912 PL4 D60

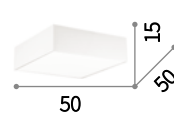

⊕ IP20

E27 max 4 x 60W  
152899 PL4 D50

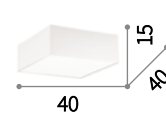

⊕ IP20

E27 max 4 x 52W  
152875 PL4 D40









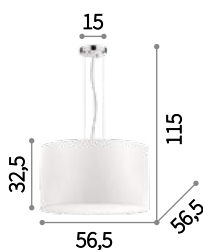

# Wheel

Montatura circolare in metallo smaltato.  
Paralume in lamina di PVC rivestita di tessuto. Cavi in acciaio a lunghezza regolabile con dispositivi ferma cavo automatici.



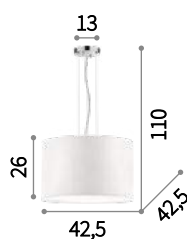



 IP20  
 E27 max 5 x 60W  
 009698 SP5

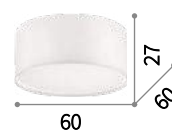



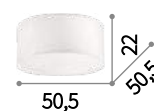

 IP20  
 E27 max 3 x 60W  
 009681 SP3





 IP20  
 E27 max 5 x 60W  
 036021 PL5





 IP20  
 E27 max 3 x 60W  
 036014 PL3







# Hilton

Montatura in cromo. Paralume in lamina di PVC rivestita in tessuto. Sul fondo, diffusore in vetro trasparente sabbiato. Sospensioni con cavi a lunghezza regolabile.

 Lampadine ALO G9 28W 2700 K incluse nei modelli: SP4 Linear, AP1 e TL1.

 Lampada con interruttore integrato nei modelli: TL2, TL1 e PT2.

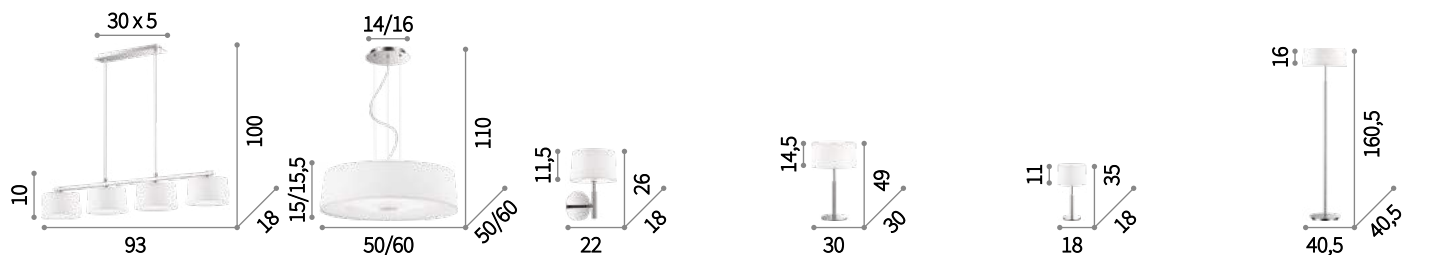

  IP20 



G9 max 4 x 40W  
075495 SP4 Linear Bianco

  IP20

E27 max 4 / 6 x 60W  
075501 SP4 Round Bianco  
075518 SP6 Round Bianco

  IP20 

G9 max 1 x 40W  
075471 AP1 Bianco  
164601 AP1 Nero

  IP20

E14 max 2 x 40W  
075532 TL2 Bianco

  IP20 

G9 max 1 x 40W  
075525 TL1 Bianco

  IP20

E14 max 2 x 40W  
075488 PT2 Bianco







# Isa

Montatura in metallo cromato. Paralumi in lamina di pvc trasparente avvolto da nastri in tessuto leggero di colore bianco. Diffusore in vetro trasparente sabbaiato.



Lampadine ALO G9 28W 2700 K incluse nei modelli: AP1 e TL1.



Lampada con interruttore integrato nei modelli: TL1 e PT2.

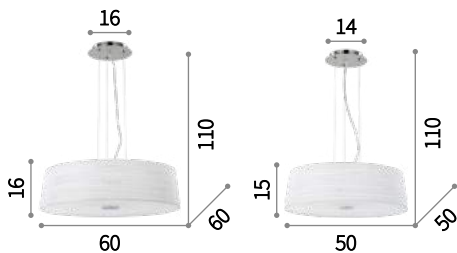

⊕ ⊖ IP20

E27 max 6 x 60W

016535 SP6

⊕ ⊖ IP20

E27 max 4 x 60W

043531 SP4

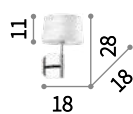

⊕ ⊖ IP20 

G9 max 1 x 40W

000589 AP1

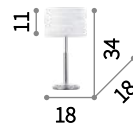

⊕ ⊖ IP20 

G9 max 1 x 40W

016559 TL1

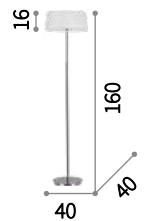

⊕ ⊖ IP20

E14 max 2 x 40W

018546 PT2





074917



074931

# Sheraton

Montatura in metallo cromato. Paralumi in lamina di PVC rivestita di tessuto. Applique con luci a controllo indipendente da interruttore unico.

 Lampadine ALO G9 28W 2700 K incluse nel modello TL1.

 Sorgente luminosa LED 3000 K nel modello AP2, 15.000 h di durata.

 Lampada con interruttore integrato nei modelli: AP2, TL1 e PT1.

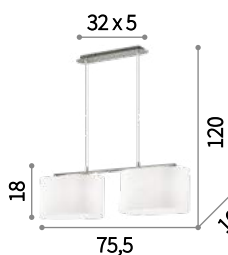

  IP20

E14 max 4 x 40W  
074962 SP4 Bianco

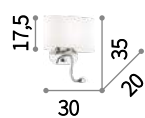

  IP20

E14 max 1 x 40W +  
LED 1W / 45 Lm  
074900 AP2 Bianco  
074917 AP2 Marrone



  IP20 

G9 max 1 x 40W  
075013 TL1 Bianco

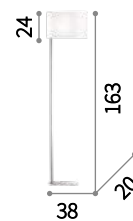

  IP20

E27 max 1 x 60W  
074931 PT1 Bianco







199962



221342

# Circus

Corpo luce interamente in metallo con finitura in vernice bianca o rossa lucida.

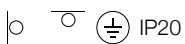
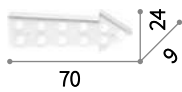

E14 max 11 x 40W

153513 Circus-1AP11Bianco  
153520 Circus-1AP11Rosso

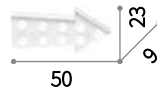

E14 max 9 x 40W

153537 Circus-1AP9Bianco  
153544 Circus-1AP9Rosso

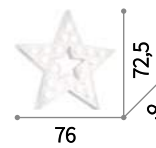

E14 max 20 x 40W

199962 Circus-2AP20Bianco  
221359 Circus-2AP20Rosso

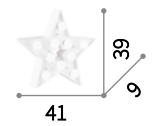

E14 max 10 x 40W

203041 Circus-2AP10Bianco  
221342 Circus-2AP10Rosso







# Multiflex

Montatura in metallo rifinito con vernice opaca. Bracci flessibili rivestiti di gomma. Cavo in acciaio regolabile in lunghezza da dispositivo automatico.

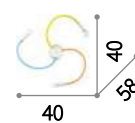
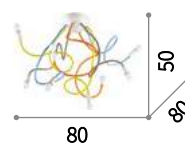
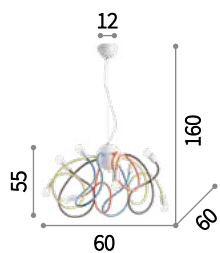
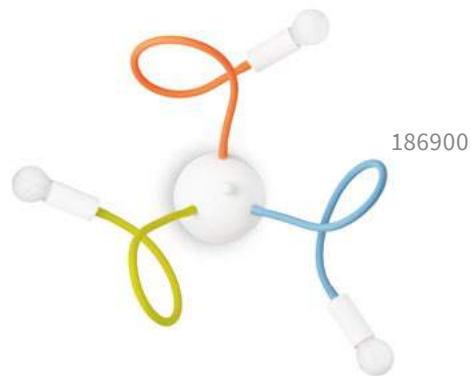

⊕ ⊖ IP20

E14 max 8 x 40W  
 141893 SP8 Bianco  
 141909 SP8 Color  
 141916 SP8 Nero

⊕ ⊖ IP20

E14 max 8 x 40W  
 159010 PL8 Color

⊕ ⊖ ⚠ IP20

E14 max 3 x 40W  
 186900 AP3 Color







# Dream Big

Rosone in metallo verniciato opaco. Cavo in tessuto. Diffusore in vetro soffiato bianco acidato. Cesto in corda.

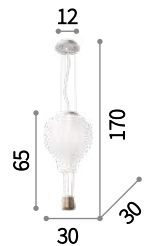

⊕ ⊖ IP20

E27 max 1x42W

179858 SP1



# Titti

Montatura in metallo con elementi in legno naturale. Diffusori in metallo. Rifinito con vernice lucida.

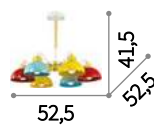

⊕ ⊖ IP20  
E27 max 6 x 60W  
157160 PL6

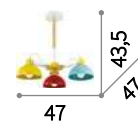

⊕ ⊖ IP20  
E27 max 3 x 60W  
157146 PL3

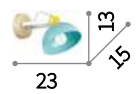

⊕ ⊖ IP20  
E27 max 1 x 60W  
157139 AP1 Azzurro  
157122 AP1 Rosso



# Ecoflex

Struttura a bracci flessibili in metallo cromato, modellabili a piacere. Diffusori in vetro colorato soffiato e acidato.

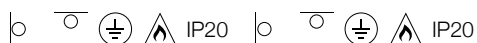
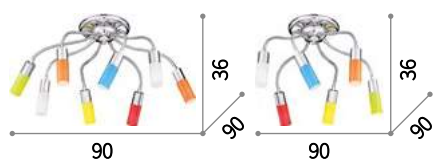

E14 max 8 x 40W

044545 PL8

E14 max 6 x 40W

044538 PL6



# Flower

Montatura centrale in metallo con elementi decorativi in materiale acrilico multicolore.

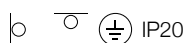
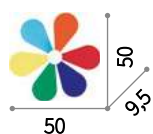

E27 max 1 x 60W

141336 PL1 D50

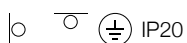
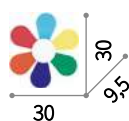

E27 max 1 x 60W

141329 AP1 D30









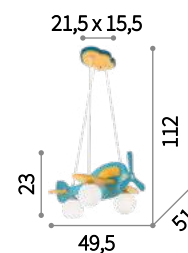

# Avion

Corpo luce e rosone in legno dipinto con vernice opaca. Dettagli in metallo cromato. Diffusori in vetro soffiato bianco acidato.

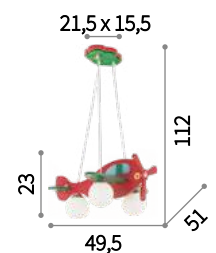

 IP20  
 E14 max 3 x 40W  
 136325 Avion-1 SP3



 IP20  
 E14 max 3 x 40W  
 136318 Avion-2 SP3

# Parete e soffitto







133409

# Nodino

Montatura in metallo con finitura in cromo o in vernice opaca bianca. Diffusori in vetro bianco soffiato e acidato.

**LED** Lampadine LED G9 3,2W 3000 K incluse. Cod. 209043



133386

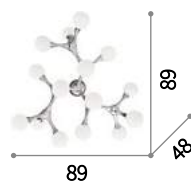

G9 max 15 x 15W

149608 PL15 Bianco  
133409 PL15 Cromo

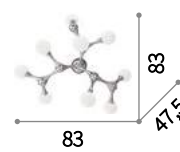

G9 max 9 x 15W

149622 PL9 Bianco  
133393 PL9 Cromo

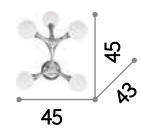

G9 max 5 x 15W

149615 PL5 Bianco  
133386 PL5 Cromo









# Nodi Crystal

Montatura in metallo cromato. Diffusori composti da anelli in metallo cromato con ottagoni di cristallo incastonati all'interno.

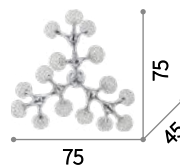



Lampadine ALO G9 28W 2700 K incluse.



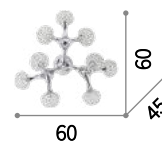



 IP20  
 G9 max 15 x 40W  
 093512 PL15

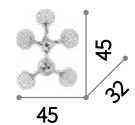



 IP20  
 G9 max 9 x 40W  
 093505 PL9

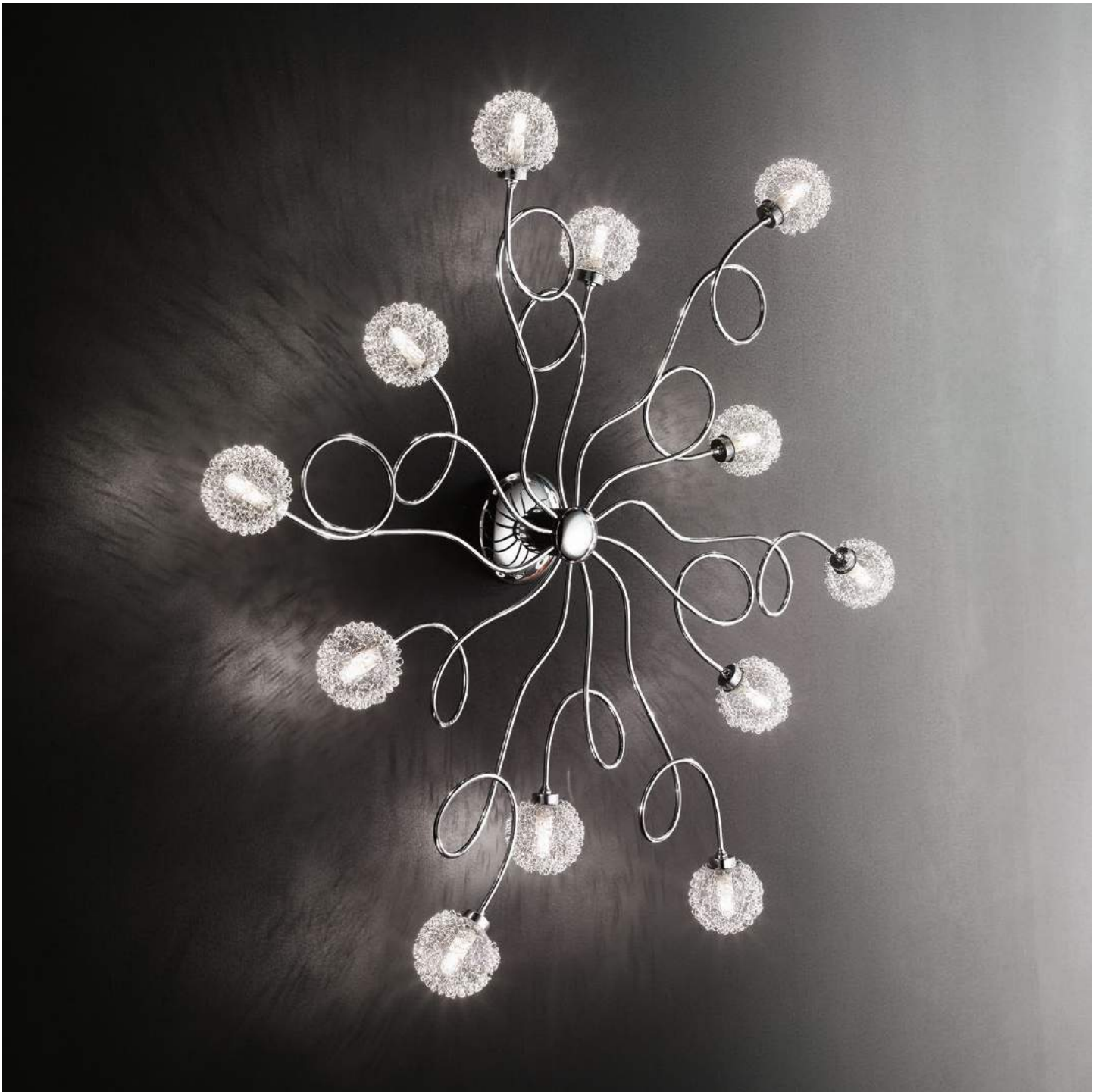



 IP20  
 G9 max 5 x 40W  
 098043 PL5



# Pon Pon

Montatura in metallo cromato modellato artigianalmente. Diffusori con bolle di vetro soffiato avvolte da filamento in alluminio.



Lampadine ALO G9 28W 2700 K incluse.

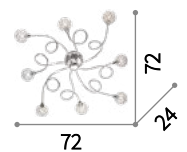
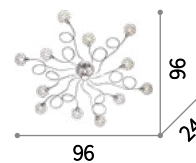

G9 max 12 x 40W

074641 PL12



G9 max 8 x 40W

074665 PL8



004211

# Tender

Montatura in cromo con bracci flessibili.  
Diffusori trasparenti in vetro pirex soffiato  
con parte interna smerigliata. Diffusori  
colorati in pasta di vetro soffiato e  
incamiciato.

**ON** Lampada con interruttore integrato  
**OFF** nel modello AP1.



006550

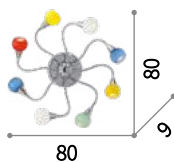

⊙ ⊙ ⊕ ⚡ IP20

E14 max 8 x 40W

007113 PL8 Color  
004211 PL8 Trasparente

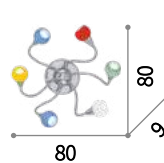

⊙ ⊙ ⊕ ⚡ IP20

E14 max 6 x 40W

006550 PL6 Color  
028699 PL6 Trasparente

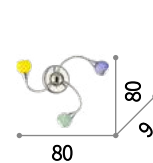

⊙ ⊙ ⊕ ⚡ IP20

E14 max 3 x 40W

006543 PL3 Color  
028682 PL3 Trasparente

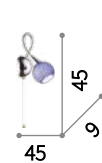

⊙ ⊕ ⚡ IP20

E14 max 1 x 40W

006529 AP1 Color  
004235 AP1 Trasparente

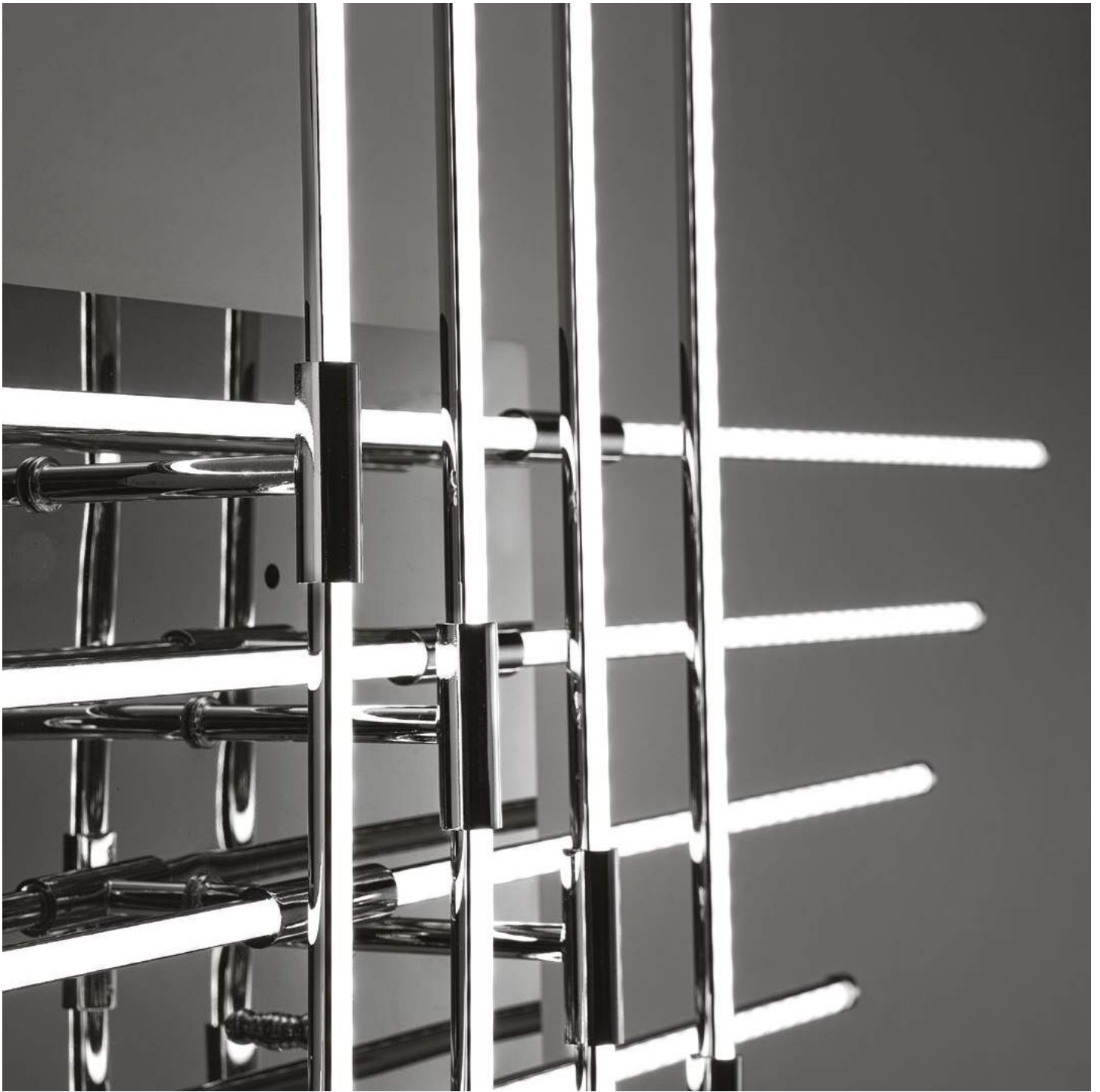

# Cross

Montatura in metallo cromato con LED integrati su bacchette removibili per una rapida sostituzione.

**LED** Sorgente luminosa LED 3000 K, 20.000 h di durata.

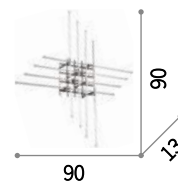
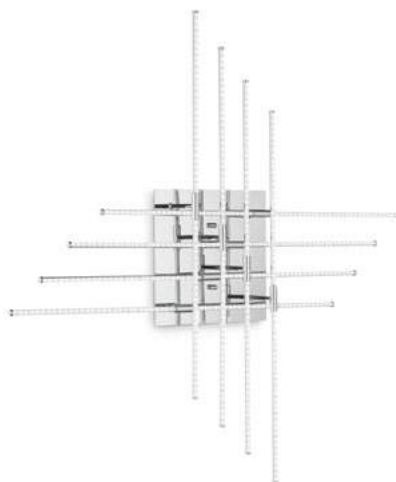

LED 38,4W / 2000 Lm  
114767 PL480

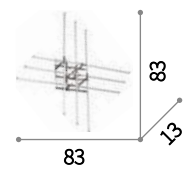

LED 28,8W / 1500 Lm  
114750 PL360





# Mikado

Montatura in metallo cromato. Diffusori in materiale acrilico satinato. Sorgente luminosa a led integrati.

**LED** Sorgente luminosa LED 3000 K, 20.000 h di durata.

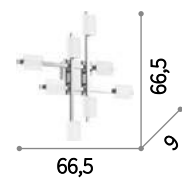

IP20  
 LED 56W / 4400 Lm  
 196657 PL8

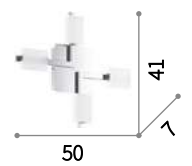

IP20  
 LED 28W / 2600 Lm  
 196640 PL4



# Rubens

Montatura e ferma vetro centrale in metallo rifinito bianco opaco. Diffusore in vetro trasparente con graniglia.

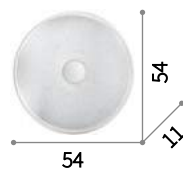

**LED** Sorgente luminosa LED 3000 K, 20.000 h di durata.



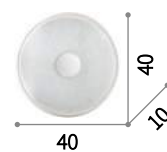

 IP20  
 LED 50W / 4000 Lm  
 178790 AP50



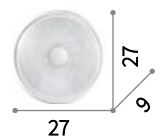

 IP20  
 LED 24W / 1920 Lm  
 178783 AP24





 IP20  
 LED 10W / 800 Lm  
 178776 AP10





# Sunrise

Corpo luce interamente in metallo rifinito con vernice opaca. Disponibile tutto bianco o nero con interno in foglia oro.



Lampadine ALO G9 28W 2700 K incluse.



133294

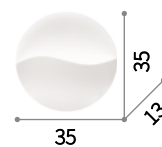

G9 max 4 x 40W

133294 AP4 Bianco  
133300 AP4 Nero Oro

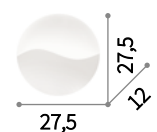

G9 max 3 x 40W

133263 AP3 Bianco  
133270 AP3 Nero Oro



124179

## Holiday

Montatura in metallo con base in vernice opaca e struttura in cromo. Paralume con lamina di pvc rivestita in tessuto. Interruttore unico con controllo indipendente delle due sorgenti luminose.

**LED** Sorgente luminosa LED 3000 K, 15.000 h di durata.

**ON OFF** Lampada con interruttore integrato.

124162

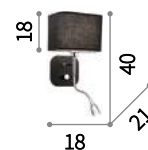

⊕ IP20

E14 max 1 x 40W + LED 1W / 45 Lm

124162 AP2 Bianco  
124179 AP2 Nero





035956

# Hotel

Paralume rivestito in tessuto. Diffusori in vetro satinato. Modello AP2 con LED esterno orientabile e interruttore indipendente.

**LED** Sorgente luminosa LED 3000 K nel modello AP2, 15.000 h di durata.

**ON OFF** Lampada con interruttore integrato nel modello AP2.



103204

035949

215709

152851

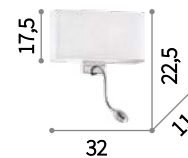

⌀ IP20

⌀ IP20

E27 max 1 x 60W +  
LED 1W / 45 Lm

E27 max 1 x 60W  
152851 AP1 Bianco

215709 AP2 All Black  
215693 AP2 All White  
035949 AP2 Bianco  
103204 AP2 Canvas  
035956 AP2 Nero



# Union

Montatura in metallo rifinito con vernice opaca bianca. Diffusore con lastra di vetro trasparente acidato, fissato con magneti.

**LED** Lampadine LED GX53 9,5W 3000 K incluse. Cod. 123936

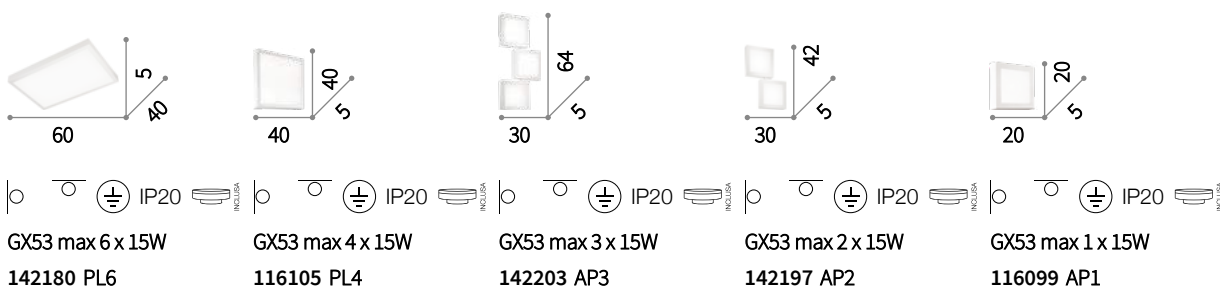



138640

# Universal

Montatura in metallo in varie finiture.  
Diffusore a led in materiale plastico.

**LED** Sorgente luminosa LED 3000 K,  
25.000 h di durata.



141480



141497

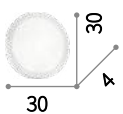

IP20  
LED 24W / 1400 Lm

138619 24W Round Bianco  
141497 24W Round Cromo  
141480 24W Round Nickel

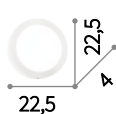

IP20  
LED 18W / 1050 Lm

138602 18W Round Bianco

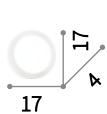

IP20  
LED 12W / 700 Lm

138596 12W Round Bianco

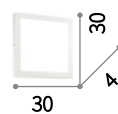

IP20  
LED 24W / 1400 Lm

138657 24W Square Bianco

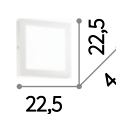

IP20  
LED 18W / 1050 Lm

138640 18W Square Bianco

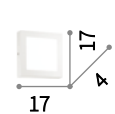

IP20  
LED 12W / 700 Lm

138633 12W Square Bianco

# Commodore

Corpo luce interamente in metallo con finitura in vernice bianca opaca.



Lampadine LED GX53 9,5W 3000 K incluse. Cod. 123936

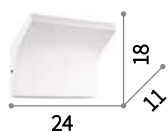

GX53 max 2 x 15W

125923 AP2

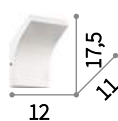

GX53 max 1 x 15W

125886 AP1



# Fix

Base in metallo. Diffusore-dissipatore in lastra d'alluminio da 6 mm di spessore. LED integrati.



Sorgente luminosa LED 3000 K, 20.000 h di durata.

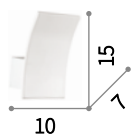

LED 5W / 420 Lm

117867 AP1 Bianco  
123066 AP1 Cromo







# Vela

Base in metallo verniciato. Diffusore-dissipatore in lastra curva d'alluminio da 6 mm di spessore.

**LED** Sorgente luminosa LED 3000 K, 15.000 h di durata.



IP20

LED 5W / 180 Lm

090337 AP1





# Gingle

Base e corpo luce in metallo verniciato a polveri. Sorgente luminosa a led integrati con emissione di luce riflessa.

**LED** Sorgente luminosa LED 3000 K, 17.500 h di durata.

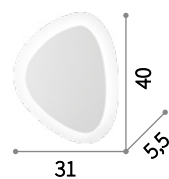

IP20  
 LED 34W / 3550 Lm  
 196220 AP170 Big

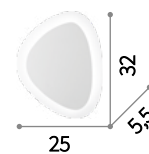

IP20  
 LED 26W / 2585 Lm  
 196206 AP125 Medium

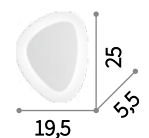





IP20  
 LED 18W / 1940 Lm  
 196190 AP90 Small



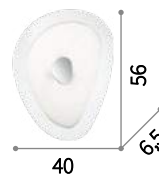



# Geko

Montatura in metallo smaltato bianco.  
 Diffusore con vetro trasparente  
 serigrafato in bianco. Elemento centrale  
 fissa vetro in metallo cromato.

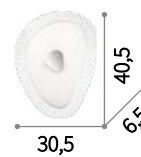





 IP20  
 E27 max 4 x 60W  
 116112 PL4

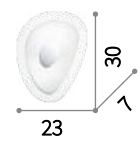





 IP20  
 E27 max 3 x 60W  
 018508 PL3







 IP20  
 E27 max 2 x 60W  
 010861 PL2





142333

# Tea

Corpo luce in fusione di alluminio rifinito con vernici opache a polveri. Doppio diffusore in acrilico trasparente satinato: uno sopra e uno sotto.

**LED** Sorgente luminosa LED 3000 K, 30.000 h di durata.



142340

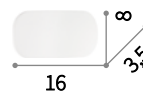

⊕ IP20

LED 6W / 450 Lm

142340 AP30 Bianco  
142333 AP30 Nero





# Posta

Corpo luce in metallo disponibile in alluminio spazzolato, in cromo o smaltato. Diffusore composto di tre vetri trasparenti smerigliati.



⊙ ⊕ IP20

E14 max 4 x 40W

009957 AP4 Alluminio  
051987 AP4 Bianco  
051956 AP4 Cromo

⊙ ⊕ IP20

E14 max 3 x 40W

009933 AP3 Alluminio  
051970 AP3 Bianco  
051949 AP3 Cromo

⊙ ⊕ IP20

E14 max 2 x 40W

009940 AP2 Alluminio  
051963 AP2 Bianco  
051932 AP2 Cromo

# Zed

Base in metallo. Diffusore-dissipatore in lastra d'alluminio da 6 mm di spessore. LED integrati.

**LED** Sorgente luminosa LED 3000 K, 20.000 h di durata.



115153



115177



115191



IP20

LED 5W / 390 Lm

115153 AP1 Oval Bianco  
115160 AP1 Oval Cromo

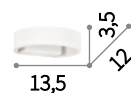

IP20

LED 5W / 390 Lm

115177 AP1 Round Bianco

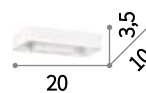

IP20

LED 5W / 390 Lm

115191 AP1 Square Bianco





115160



# Paul

Montatura in metallo rifinito bianco.  
Diffusore in vetro bianco soffiato,  
incamiciato e acidato.

 Lampadine ALO G9 28W 2700 K  
includi.



  IP20 

G9 max 2x 40W

060620 AP2



# Puzzle

Montatura in metallo cromato. Diffusore in  
vetro soffiato, incamiciato e acidato. Bianco  
all'interno e all'esterno disponibile in bianco  
e in nero.

 Lampadine ALO G9 28W 2700 K  
includi.

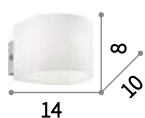

  IP20 

G9 max 1x 40W

035185 AP1 Bianco  
035192 AP1 Nero

035192





# Anello

Montatura in metallo cromato. Diffusore disponibile in vetro soffiato incamiciato e acidato oppure in vetro trasparente cromato. Copri lampadina in vetro pirex satinato.

 Lampadine ALO G9 28W 2700 K incluse.



028361



028323

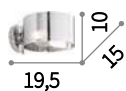

G9 max 1 x 40W

028361 AP1 Bianco  
028323 AP1 Cromo

# Box

Montatura in metallo cromato. Diffusore in vetro soffiato, incamiciato e acidato. Bianco all'interno e colorato all'esterno.

 Lampadine ALO G9 28W 2700 K incluse.

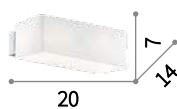

G9 max 2 x 40W

009537 AP2 Bianco  
009513 AP2 Nero



009537

009513



# Almond

Montatura in metallo verniciato bianco opaco. Elementi diffusori in vetro soffiato bianco incamiciato e acidato.



⊕ ⊖ IP20

E27 max 9 x 60W

159645 PL9

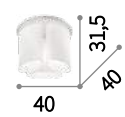

⊕ ⊖ IP20

E27 max 3 x 60W

159638 PL3



# Moris

Diffusore in vetro soffiato incamiciato e acidato bianco o in vetro trasparente rifinito in cromo.



Lampadine ALO G9 28W 2700 K incluse.

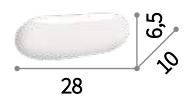

G9 max 2 x 40W  
 034546 AP2 Bianco  
 134987 AP2 Cromo

# Clip

Corpo luce interamente in lamina di metallo con varie finiture. Nella versione piccola, diffusori in vetro pirex sabbato.

 Lampadine ALO G9 28W 2700 K incluse nel modello AP2 Mini.



088273



014166





187365



088266



  IP20

  IP20 

E27 max 2 x 60W

G9 max 2 x 40W

088273 AP2 Small Argento    091136 AP2 Mini Argento  
 014166 AP2 Small Bianco    049236 AP2 Mini Bianco  
 187365 AP2 Small Corten    170923 AP2 Mini Corten  
 031361 AP2 Small Cromo    049229 AP2 Mini Cromo  
 088266 AP2 Small Oro        091129 AP2 Mini Oro





031361



# Lumina

Corpo luce in metallo con finitura disponibile in brunito, cromo o nickel satinato. Diffusore in vetro trasparente acidato.



Lampadine ALO R7s 70W 78 mm  
2700 K incluse.



002507



007557



002491

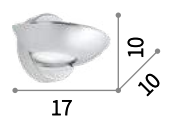

R7s max 1 x 80W

002507 AP1 Brunito  
007557 AP1 Cromo  
002491 AP1 Nickel

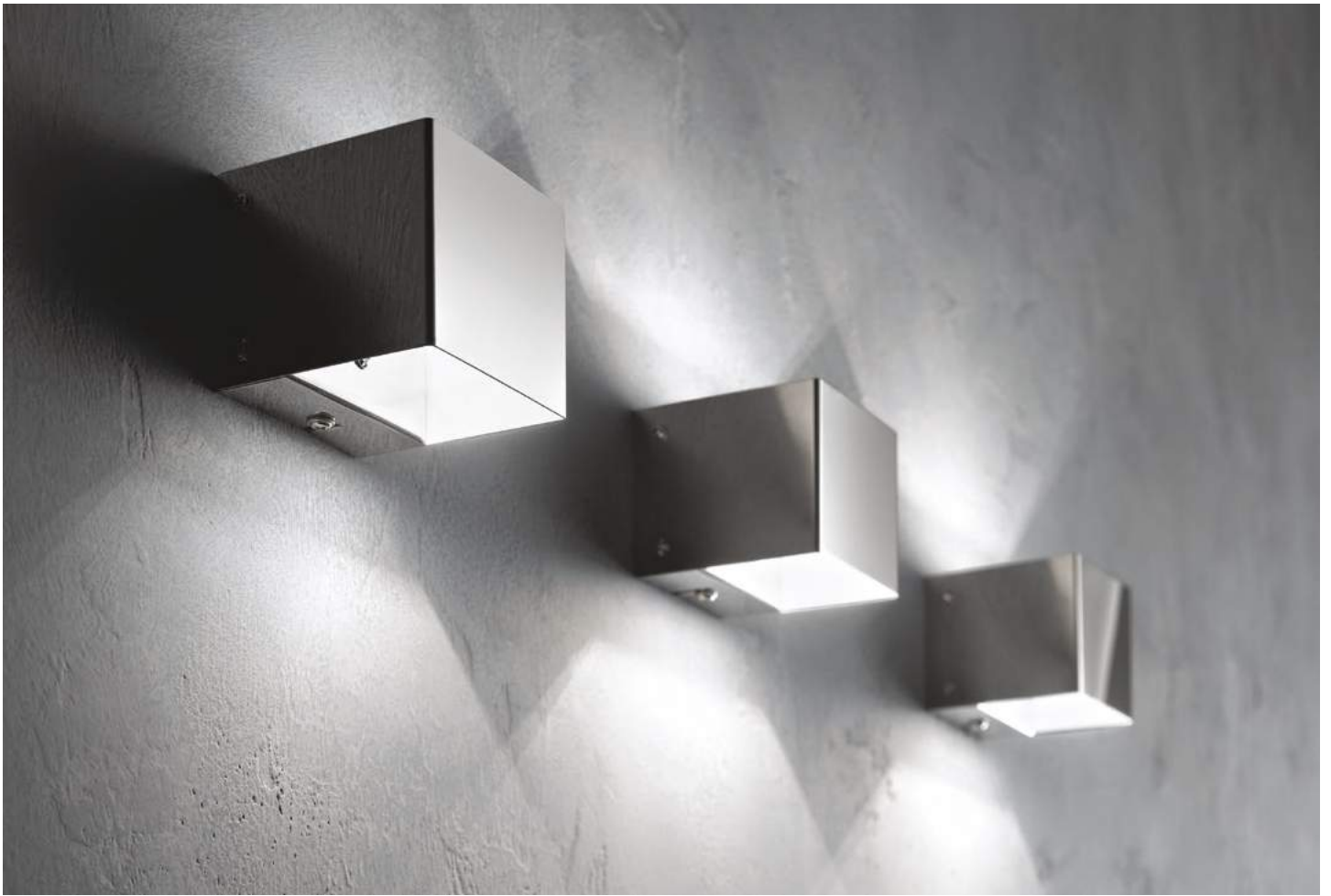

# Flash

Corpo luce in metallo con finitura in corten, cromo o vernice opaca bianca.



Lampadine ALO G9 28W 2700 K incluse.



 095264

 169118

 007380

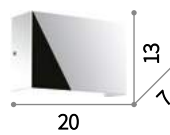

G9 max 2 x 40W

200910 AP2 High Bianco  
200927 AP2 High Corten  
200934 AP2 High Cromo

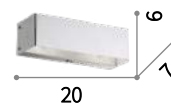

G9 max 2 x 40W

095288 AP2 Bianco  
169125 AP2 Corten  
007397 AP2 Cromo

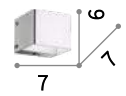

G9 max 1 x 40W

095264 AP1 Bianco  
169118 AP1 Corten  
007380 AP1 Cromo









# Evolution

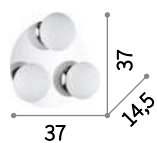

Base in metallo cromato. Diffusori in vetro bianco soffiato e acidato. Grado di impermeabilità IP44. Led integrato.

**LED** Sorgente luminosa LED 3000 K, 17.500 h di durata.



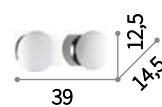

 IP44  
 LED 15W / 1150 Lm  
 193106 PL3





 IP44  
 LED 10W / 750 Lm  
 193137 PL2





 IP44  
 LED 5W / 400 Lm  
 193090 PL1





# Totem

Base in metallo sagomato a laser e verniciato opaco. Lampadine led GX53 sostituibili.

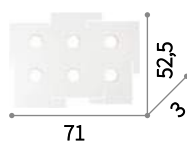
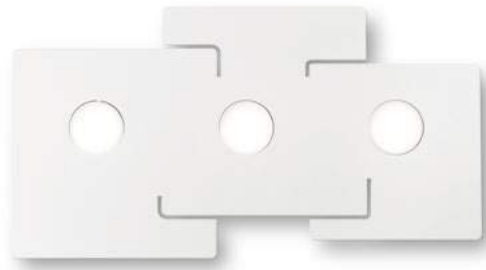

IP20  
 GX53 max 6 x 15W  
 215785 PL6

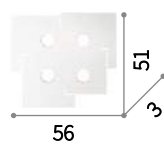

IP20  
 GX53 max 4 x 15W  
 215778 PL4

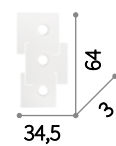

IP20  
 GX53 max 3 x 15W  
 215761 PL3

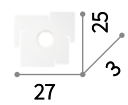

IP20  
 GX53 max 1 x 15W  
 215747 PL1





# Mito

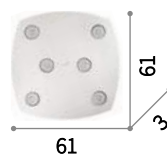

Montatura in metallo con finitura  
in vernice opaca. Lampadine GX53  
sostituibili.

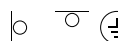
**LED** Lampadine LED GX53 9,5W 3000 K  
incluse. Cod. 123936



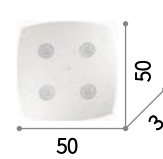

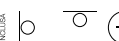
 IP20
 
  
 GX53 max 6 x 15W  
 175690 PL6

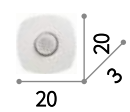

 IP20
 
  
 GX53 max 4 x 15W  
 175706 PL4

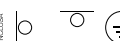

 IP20
 
  
 GX53 max 1 x 15W  
 175676 PL1







# Logos

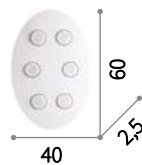



Montatura in metallo con finitura in vernice opaca. Lampadine GX53 sostituibili.

**LED** Lampadine LED GX53 9,5W 3000 K incluse. Cod. 123936

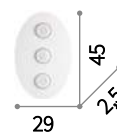





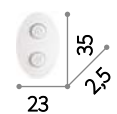

 IP20
 
  
 GX53 max 6 x 15W  
 175799 PL6





 IP20
 
  
 GX53 max 3 x 15W  
 175768 PL3





 IP20
 
  
 GX53 max 2 x 15W  
 175720 AP2







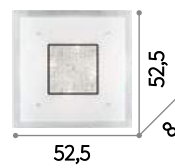





# Steno

Base in metallo con vetro serigrafato e sabbato. Diffusore in vetro con decorazione serigrafata e applicazioni di elementi in cristallo molato.

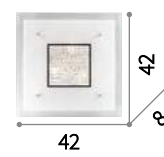



 IP20  
 E27 max 4 x 60W  
 087597 PL4



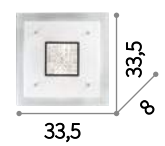

 IP20  
 E27 max 3 x 60W  
 087580 PL3





 IP20  
 E27 max 2 x 60W  
 087573 PL2





# Ikes

Base e dettagli in metallo cromato.  
Diffusore in lastra di vetro trasparente con  
zone circolari sabbiate. Led integrati.

**LED** Sorgente luminosa LED 3000 K,  
20.000 h di durata.

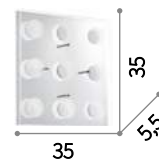

⌀ ⌀ Ⓧ IP20  
LED 45W / 2800 Lm  
196732 PL9

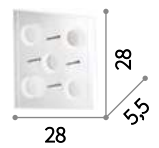

⌀ ⌀ Ⓧ IP20  
LED 25W / 1500 Lm  
196725 PL5

# Ocean

Diffusore composto da due lastre di vetro: sotto con bordo a specchio e smerigliato al centro, sopra con decorazione serigrafata e applicazioni di bottoni in vetro.



091013



081434

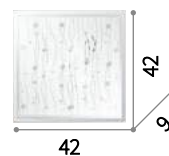

42

42

9

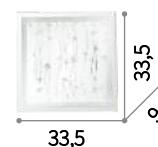

33,5

33,5

9



E27 max 3 x 60W

091013 PL3 Color

081441 PL3 Trasparente



E27 max 2 x 60W

091006 PL2 Color

081434 PL2 Trasparente

# Esil

Diffusore in vetro trasparente sabbato con decorazione serigrafata e applicazioni di elementi in cristallo molato. Viti ferma vetro in metallo cromato.

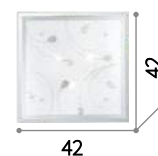

42

42

9

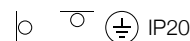

E27 max 3 x 60W

080390 PL3



# Flat

Montatura in metallo smaltato bianco opaco. Diffusore in lastra di acrilico satinato trasparente.

**LED** Lampadine LED GX53 9,5W 3000 K incluse. Cod. 123936

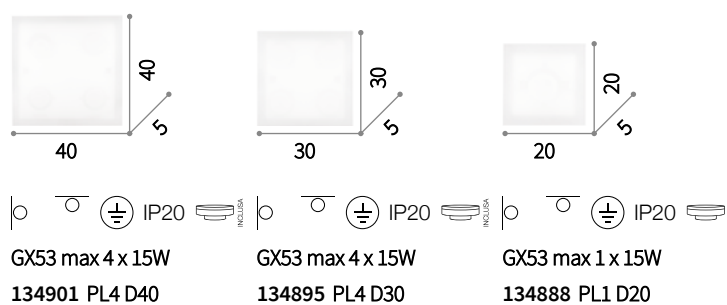

# Dony

Diffusore in vetro trasparente soffiato ed acidato. Decorazioni serigrafate in bianco. Ganci ferma vetro in metallo cromato.

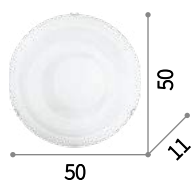

⊕ ⊖ ⊕ ⊕ IP20  
E27 max 4 x 60W  
019642 PL4

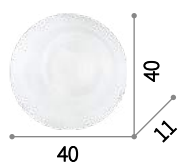

⊕ ⊖ ⊕ ⊕ IP20  
E27 max 3 x 60W  
019635 PL3

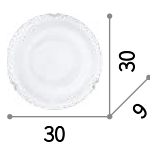

⊕ ⊖ ⊕ ⊕ IP20  
E27 max 2 x 60W  
020891 PL2

# Save

Montatura in metallo cromato. Diffusore in vetro soffiato bianco acidato.

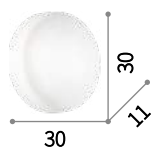

⊕ ⊖ ⊕ IP20  
E27 max 1 x 60W  
093345 PL1





# Ring

Montatura in metallo cromato. Diffusore in vetro bianco soffiato e acidato con fissaggio a baionetta.

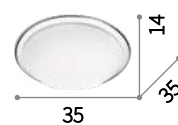

⊕ ⊖ ⊕ ⚠ IP20  
E27 max 3 x 60W  
045733 PL3

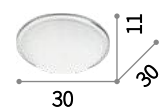

⊕ ⊖ ⊕ ⚠ IP20  
E27 max 2 x 60W  
045726 PL2

# Toffee

Base in metallo cromato. Diffusore in vetro trasparente acidato.

**LED** Lampadine LED GX53 9,5W 3000 K incluse. Cod. 123936

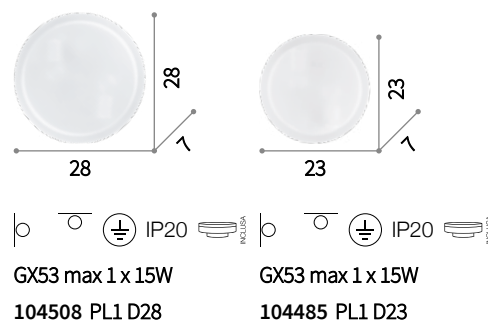

# Iris

Base in metallo cromato. Diffusore in vetro trasparente acidato.



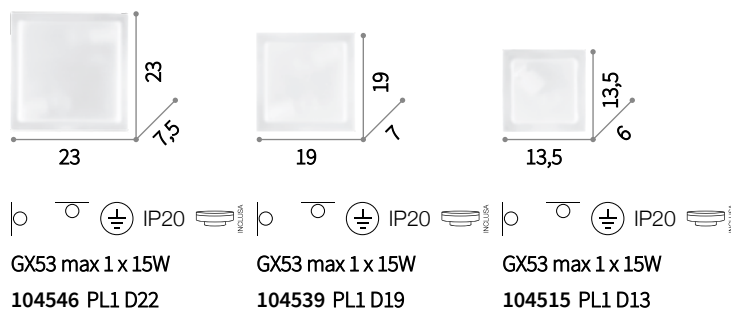

**LED** Lampadine LED GX53 9,5W 3000 K incluse. Cod. 123936



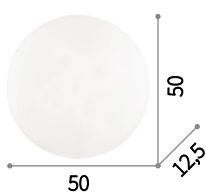



# Simply

Diffusore in vetro trasparente sabbiato.  
Ganci ferma vetro in metallo smaltato con sistema di bloccaggio a molla.

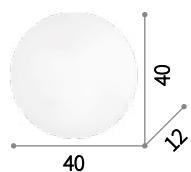





 IP20  
 E27 max 4 x 60W  
 007991 PL4

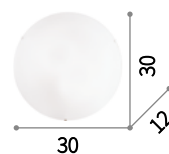







 IP20  
 E27 max 3 x 60W  
 007984 PL3

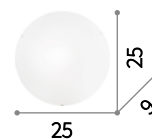



 IP20  
 E27 max 2 x 60W  
 007977 PL2









 IP20  
 E27 max 1 x 60W  
 007960 PL1

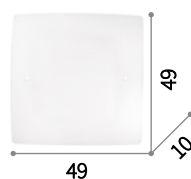

# Celine

Base in metallo smaltato. Diffusore in vetro trasparente sabbiato. Viti ferma vetro in metallo cromato.



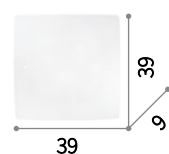



 IP20  
 E27 max 4 x 60W  
 044293 PL4

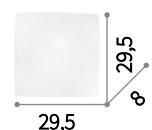



 IP20  
 E27 max 3 x 60W  
 044286 PL3





 IP20  
 E27 max 2 x 60W  
 044279 PL2

# Tek

Montatura in metallo cromato. Diffusore con lastra in vetro trasparente molato e smerigliato nella zona centrale.

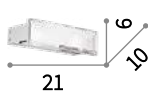

Lampadine ALO G9 28W 2700 K incluse.



G9 max 3 x 40W

052151 AP3



G9 max 2 x 40W

052144 AP2

# Triplo

Diffusore con triplo vetro, uno trasparente e piano alla base e due smerigliati ad acido e ricurvi sulla parte superiore. Elementi ferma vetro in metallo cromato.

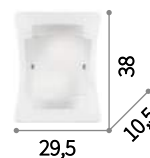

E27 max 2 x 60W

026480 AP2



E27 max 1 x 60W

026473 AP1





## Audi-B

Montatura in metallo cromato. Diffusore in lastra di vetro trasparente con spessore di 10 mm. Emette luce verso l'alto e verso il basso.



Lampadine ALO R7s 80W 78 mm  
2700 K incluse.

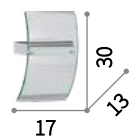

R7s max 1x100W  
017082 AP1

# Ali

Diffusore in vetro bianco acidato composto da tre elementi: due laterali e uno frontale. Viti fermavetro cromate.

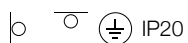
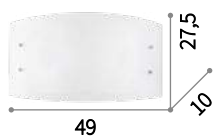

E27 max 4 x 60W

026565 PL4

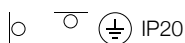

E27 max 2 x 60W

026558 AP2

# Denis

Diffusore con triplo vetro. Due laterali in vetro trasparente acidato e uno frontale trasparente con decorazione bianca centrale serigrafata.



Lampadine ALO R7s 100W 118 mm 2700 K incluse.



R7s max 1 x 100W

005454 AP1 Medium



R7s max 1 x 100W

005294 AP1 Small







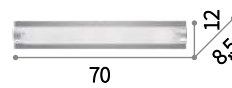

# Tudor

Base in metallo cromato. Diffusore composto da cornice in vetro trasparente molato e mezzo tubo in vetro pirex sabbato nella parte centrale.



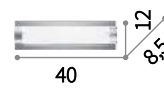

 IP20  
 E14 max 4 x 40W  
 051864 AP4



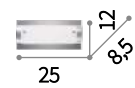

 IP20  
 E14 max 2 x 40W  
 051857 AP2







 IP20  
 E14 max 1 x 40W  
 051840 AP1

# Pila

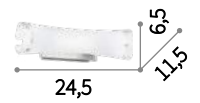
Montatura in metallo con finitura in cromo. Diffusore in vetro pirex smerigliato nella parte centrale.

 Lampadine ALO R7s 120W 118 mm 2700 K incluse.







  IP20   
R7s max 1 x 150W  
027265 AP1

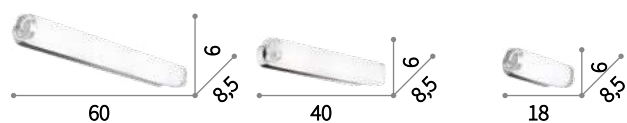

# Lulù



Base e protezioni laterali in metallo cromato. Diffusore in vetro trasparente sabbato nella zona centrale.

 Lampadine ALO R7s 70W 78 mm 2700 K incluse.



  IP20   
R7s max 3 x 80W  
060798 AP3

  IP20   
R7s max 2 x 80W  
060781 AP2

  IP20   
R7s max 1 x 80W  
060774 AP1





# Camerino

Base in alluminio. Diffusore in vetro bianco soffiato e acidato, chiuso alle estremità da dischi in materiale acrilico trasparente.





# Toy Linear

Montatura in alluminio cromato.  
Predisposto per fissaggio diretto su  
specchio. Diffusore acrilico. Driver  
esterno.

**LED** Sorgente luminosa LED 3000 K,  
20.000 h di durata.

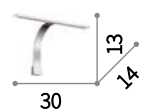

○ □ IP44

LED 7,2W / 490 Lm

005225 AP1



# Line

Montatura in metallo con finitura in cromo o in bianco satinato. Diffusore a LED con barra a sezione quadrata in acrilico satinato.

**LED** Sorgente luminosa LED 3000 K, 20.000 h di durata.

**ON OFF** Lampada con interruttore integrato.

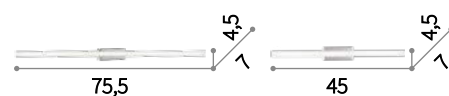

IP20

LED 8,4W / 740 Lm

118987 AP84 Bianco  
031491 AP84 Cromo

IP20

LED 4,8W / 420 Lm

118970 AP48 Bianco  
031484 AP48 Cromo



# Privè

Corpo luce interamente in metallo con varie finiture. L'assenza di diffusore consente di montare una vasta gamma di lampade con attacco E14.

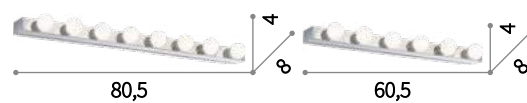

⌀ Ⓜ IP20

E14 max 8 x 40W

159522 AP8 Bianco  
045634 AP8 Cromo

⌀ Ⓜ IP20

E14 max 6 x 40W

159423 AP6 Bianco  
187570 AP6 Corten  
045627 AP6 Cromo  
159508 AP6 Nero  
179681 AP6 Ottone





045627



199870



199894

# Bonjour

Base e dettagli in metallo cromato.  
Diffusore in lastra di vetro trasparente con  
zone circolari sabbiato. Led integrati.

**LED** Sorgente luminosa LED 3000 K,  
20.000 h di durata.

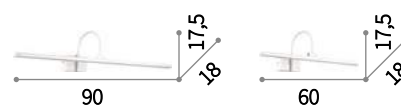

○ □ IP20

LED 12W / 900 Lm

199931 AP1 Big Bianco  
199917 AP1 Big Cromo

○ □ IP20

LED 8W / 650 Lm

199894 AP1 Small Bianco  
199870 AP1 Small Cromo





# Bow

Montatura in metallo con finitura disponibile in bianco, brunito, cromo, nickel o ottone satinato. Diffusore a LED inclinabile. Interruttore sulla base.

**LED** Sorgente luminosa LED 3000 K, 20.000 h di durata.

**ON OFF** Lampada con interruttore integrato.

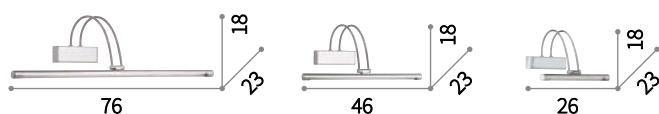

⊙ ⊕ IP20

LED 7,98W / 450 Lm

137612 AP114 Bianco  
121147 AP114 Brunito  
007021 AP114 Cromo  
007069 AP114 Nickel  
121130 AP114 Ottone Sat.

⊙ ⊕ IP20

LED 4,62W / 250 Lm

137605 AP66 Bianco  
121161 AP66 Brunito  
007045 AP66 Cromo  
007038 AP66 Nickel  
121178 AP66 Ottone Sat.

⊙ ⊕ IP20

LED 2,52W / 150 Lm

137599 AP36 Bianco  
121338 AP36 Brunito  
005386 AP36 Cromo  
005379 AP36 Nickel  
121154 AP36 Ottone Sat.





005386



# Mirror-10

Montatura in metallo con finitura disponibile in brunito, cromo o nickel. Diffusore posizionabile.

 Lampadine ALO G9 28W 2700 K include.

 017310

 017303

 017297

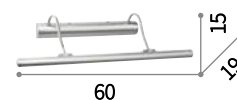

  IP20 

G9 max 4 x 40W

017310 AP4 Brunito  
017303 AP4 Cromo  
017297 AP4 Nickel

# Mirror-20

Montatura in metallo con finitura disponibile in brunito, in cromo o in ottone. Diffusore regolabile.

 Lampadine ALO G9 28W 2700 K incluse.

 Lampada con interruttore integrato.

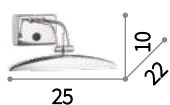

 017327

 017334

 031507



G9 max 2 x 40W

017327 AP2 Brunito  
017334 AP2 Cromo  
031507 AP2 Ottone





# Mirror-51

Montatura in metallo con finitura cromo. Diffusore posizionabile.

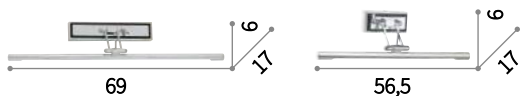
 Sorgente luminosa LED 3000 K, 15.000 h di durata.



 IP20  
LED 15W / 1500 Lm  
143842 AP75

 IP20  
LED 12W / 1200 Lm  
143859 AP60



# Arco

Montatura in metallo con finitura disponibile in cromo, brunito o nickel.  
Diffusore in tubolare di vetro pirex trasparente con schermo in rete metallica all'interno.

 Lampadine ALO R7s 120W 118 mm 2700 K incluse.

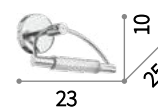

R7s max 1 x 150W

008929 AP1 Brunito  
008905 AP1 Cromo  
008912 AP1 Nickel

 008929

 008905

 008912

# Cico

Montatura in metallo con finitura disponibile in cromo, brunito o nickel.  
Diffusori indipendenti tra loro e posizionabili.

 Lampadine ALO G9 28W 2700 K incluse.



G9 max 2 x 40W

014456 AP2 Brunito  
014432 AP2 Cromo  
014449 AP2 Nickel

 014456

 014432

 014449





# Double

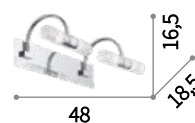

Montatura in metallo cromato. Diffusori in vetro pirex trasparente chiuso alle estremità e smerigliato a sabbia nelle parti centrali.

 Lampadine ALO G9 28W 2700 K incluse.

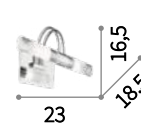

  IP20   
G9 max 4 x 40W  
018874 AP4







  IP20   
G9 max 2 x 40W  
008851 AP2

# Lucciola

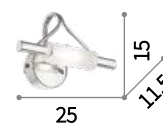
Montatura interamente in metallo, disponibile con finitura in cromo, nickel o brunito. Diffusore in vetro trasparente acidato.

 Lampadine ALO R7s 80W 78 mm 2700 K incluse.



  IP20   
R7s max 1 x 100W  
119755 AP1 Brunito  
013275 AP1 Cromo  
004358 AP1 Nickel

 119755

 013275

 004358



167121



167152

# Gim

Montatura in alluminio verniciato a polveri. Diffusore ruotabile con schermo acrilico satinato. Interruttore incorporato. LED integrati.

**LED** Sorgente luminosa LED 3000 K, 15.000 h di durata.

**ON OFF** Lampada con interruttore integrato.

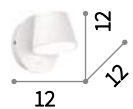

⊕ IP20

LED 6W / 530 Lm

167152 AP1 Bianco  
167121 AP1 Nero



# Hellen

Montatura in alluminio verniciato a polveri. Diffusore ruotabile con schermo acrilico satinato.

**LED** Sorgente luminosa LED 3000 K, 15.000 h di durata.

**ON/OFF** Lampada con interruttore integrato.

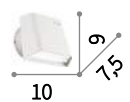

⊕ IP20  
LED 6W / 470 Lm  
176628 AP1





# Focus-1

Corpo luce in metallo con braccio flessibile orientabile rivestito in gomma. Rifinito in bianco o in nero opaco oppure in grigio con dettagli in cromo.

**LED** Sorgente luminosa LED 3000 K, 30.000 h di durata.

**ON OFF** Lampada con interruttore integrato.

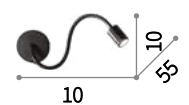

⊕ IP20

LED 3W / 200 Lm

097183 AP1 Bianco  
097206 AP1 Cromo  
097190 AP1 Nero





## Focus-2

Base e corpo luce in metallo con braccio flessibile orientabile rivestito in gomma. Interruttore sulla base. Led integrato.

**LED** Sorgente luminosa LED 3000 K, 30.000 h di durata.

**ON OFF** Lampada con interruttore integrato.

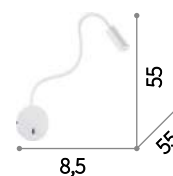

⊕ ⊖ IP20

LED 3W / 130 Lm

203171 AP1 Bianco  
203188 AP1 Cromo  
203195 AP1 Nero



142708

# Goose

Montatura e diffusore in fusione d'alluminio verniciato a polveri con colori opachi. Braccio flessibile rivestito in gomma siliconica.

**LED** Sorgente luminosa LED 3000 K, 30.000 h di durata.

**ON/OFF** Lampada con interruttore integrato.



142692



⊕ IP20

LED 3W / 200 Lm

142708 AP1 Bianco  
142692 AP1 Nero





# Page

Corpo luce in fusione di alluminio rifinito con vernice a polveri opaca. Diffusore orientabile con lente e elemento snodato in metallo cromato.

**LED** Sorgente luminosa LED 3000 K, 30.000 h di durata.

**ON OFF** Lampada con interruttore integrato.



142586



142241

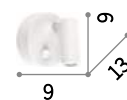

⌀ IP20

LED 3W / 210 Lm

142586 AP1 Round Bianco  
142579 AP1 Round Nero

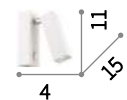

⌀ IP20

LED 3W / 210 Lm

142258 AP1 Square Bianco  
142241 AP1 Square Nero

142586

142579

# Strale

Montatura e braccio snodabile in metallo con finitura disponibile in cromo o nickel. Diffusore orientabile a piacere. Dotato di interruttore sulla base.



Lampadine ALO GU10 28W 2700 K incluse.



Lampada con interruttore integrato.

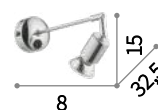

GU10 max 1 x 50W

013206 AP1 Cromo  
013183 AP1 Nickel



013206



013183

# Flex

Montatura e braccio flessibile in metallo con finitura disponibile in cromo e nickel. Diffusore orientabile a piacere. Dotato di interruttore sulla base.



Lampadine ALO GU10 28W 2700 K incluse.



Lampada con interruttore integrato.



GU10 max 1 x 50W

000305 AP1 Cromo  
006161 AP1 Nickel



000305



006161



# Orson

Montatura e braccio flessibile in metallo con finitura disponibile in cromo o nickel. Diffusore a LED orientabile a piacere. Dotato di interruttore sulla base.

**LED** Sorgente luminosa LED 4000 K, 20.000 h di durata.

**ON OFF** Lampada con interruttore integrato.



IP20

LED 3W / 200 Lm

031446 AP1 Cromo  
031453 AP1 Nickel

 031446

 031453

# Dynamo

Montatura e braccio flessibile in metallo con finitura disponibile in cromo, nickel e brunito. Diffusore orientabile a piacere. Dotato di interruttore sulla base.

**LED** Sorgente luminosa LED 4000 K, 20.000 h di durata.

**ON OFF** Lampada con interruttore integrato.

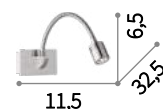

IP20

LED 3W / 200 Lm

121352 AP1 Brunito  
031460 AP1 Cromo  
031477 AP1 Nickel

 121352

 031460

 031477



098944

# Picchio

Lampada a pinza con montatura e copriportalampada in metallo. Filo elettrico in tessuto. Disponibile con finitura in cromo o smaltata in bianco.



IP20

E27 max 1x60W

098944 AP1 Bianco  
098951 AP1 Cromo

098951

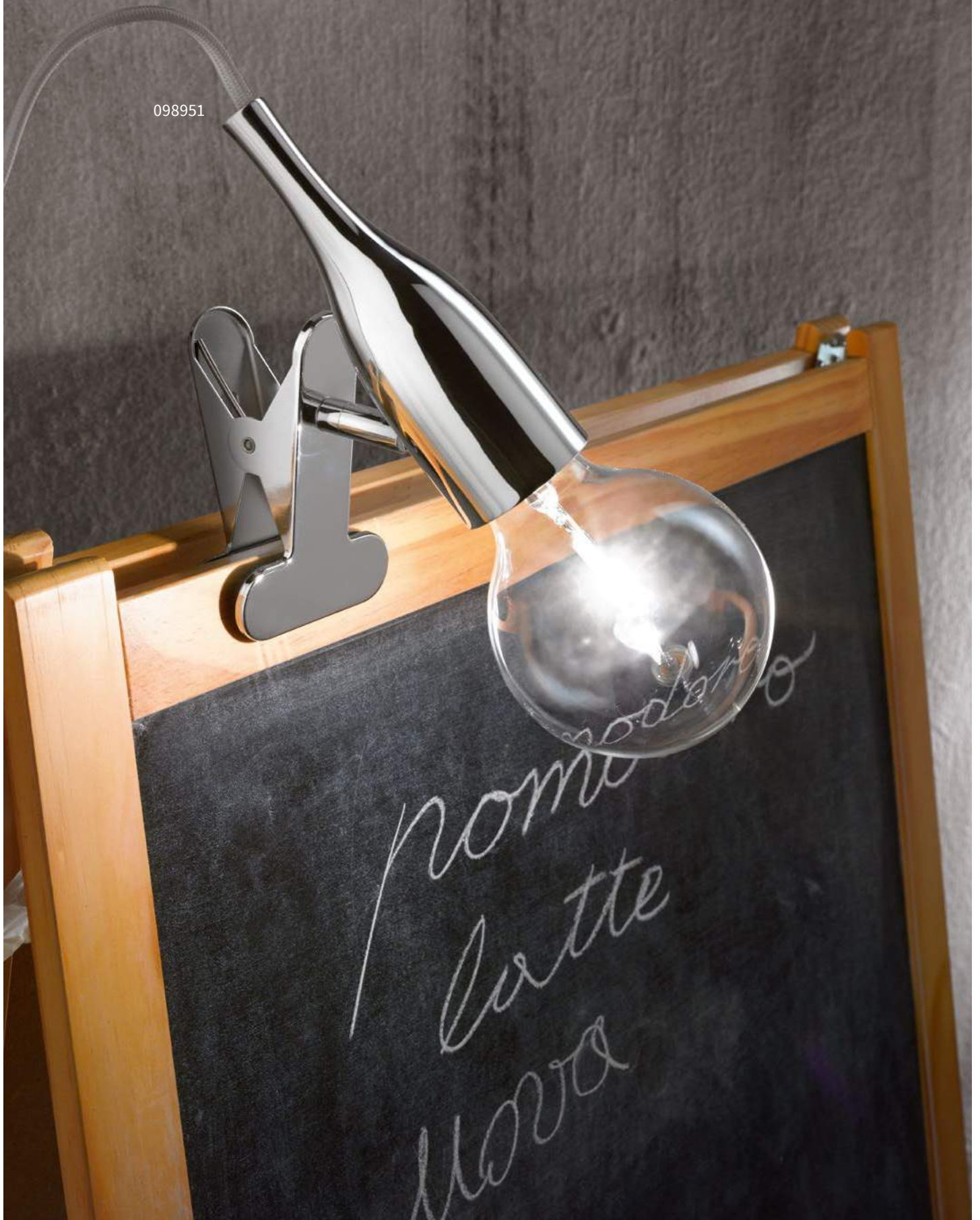



# Book

Montatura metallica verniciata a polveri.  
Diffusore in vetro satinato. Braccio  
flessibile gommato con LED. Doppio  
interruttore. Presa USB.

**LED** Sorgente luminosa LED 3000 K,  
15.000 h di durata.

**ON  
OFF** Lampada con interruttore integrato.

174972



⌀ ⚡ IP20

G9 max 1 x 28W +  
LED 3W / 130 Lm

174792 Book-1 AP2 Bianco  
174808 Book-1 AP2 Nero

⌀ ⚡ IP20

G9 max 1 x 28W +  
LED 3W / 130 Lm

174822 Book-2 AP2 Bianco  
174846 Book-2 AP2 Nero





176536

# Read

Montatura metallica verniciata a polveri.  
Diffusore orientabile con LED integrato.  
Presa USB.

**LED** Sorgente luminosa LED 3000 K,  
15.000 h di durata.

**ON**  
**OFF** Lampada con interruttore integrato.



176550

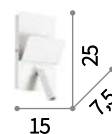

IP20

LED 3W / 130 Lm

176536 AP1 Bianco  
176550 AP1 Nero





# Oby



Montatura in metallo verniciato opaco, con snodi cromati. Corpo luce orientabile con diffusore in materiale plastico bianco.

**LED** Sorgente luminosa LED 3000 K, 20.000 h di durata.





 IP20  
 LED 24W / 1600 Lm  
 196718 PL4





 IP20  
 LED 18W / 1200 Lm  
 196701 PL3



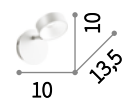

 IP20  
 LED 12W / 810 Lm  
 196695 AP2





 IP20  
 LED 6W / 450 Lm  
 196688 AP1





077888



066790

# Lunare

Base e corpo luce interamente in metallo con varie finiture. Cavo esterno rivestito da spirale metallica. Diffusori posizionabili.



Lampadine ALO GU10 28W 2700 K incluse.

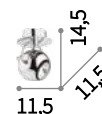
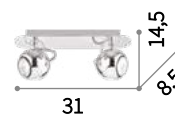
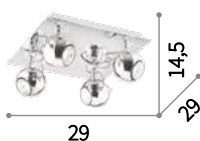

GU10 max 4 x 28W  
077918 PL4 Bianco  
066820 PL4 Cromo



GU10 max 3 x 28W  
077901 AP3 Bianco  
066813 AP3 Cromo



GU10 max 2 x 28W  
077895 AP2 Bianco  
066806 AP2 Cromo



GU10 max 1 x 28W  
077888 AP1 Bianco  
066790 AP1 Cromo







095684



095677

# Ciak

Montatura in metallo verniciato bianco o nero opaco. Diffusore posizionabile con alette mobili per l'orientamento del flusso luminoso.



Lampadine ALO GU10 28W 2700 K incluse.

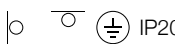
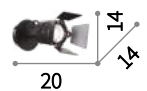
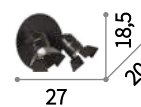
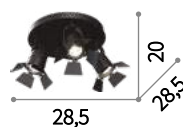
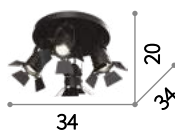

GU10 max 4 x 50W  
095707 PL4 Nero



GU10 max 3 x 50W  
122267 AP3 Bianco  
095691 AP3 Nero

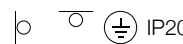

GU10 max 2 x 50W  
122274 AP2 Bianco  
095684 AP2 Nero



GU10 max 1 x 50W  
095677 AP1 Bianco  
095653 AP1 Nero











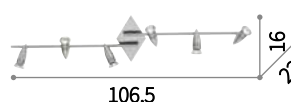
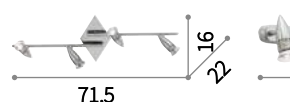
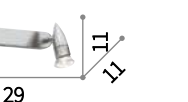
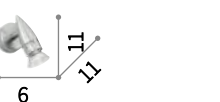













# Alfa

Montatura in metallo con finitura in cromo, brunito, bianco satinato o nickel satinato. Corpo luce posizionabile con rotazione dello stelo e snodo per l'inclinazione.

 Lampadine ALO GU10 28W 2700 K incluse.

					
	106,5	71,5	29	6	
	099057	   IP20 	   IP20 	   IP20 	   IP20 
	119786	GU10 max 6 x 50W	GU10 max 4 x 50W	GU10 max 2 x 50W	GU10 max 1 x 50W
	089560	122748 PL6 Bianco 119908 PL6 Brunito 089591 PL6 Cromo 006338 PL6 Nickel	122731 PL4 Bianco 119830 PL4 Brunito 089584 PL4 Cromo 006321 PL4 Nickel	122717 AP2 Bianco 119816 AP2 Brunito 089577 AP2 Cromo 009483 AP2 Nickel	099057 AP1 Bianco 119786 AP1 Brunito 089560 AP1 Cromo 009377 AP1 Nickel
	009377				







018829

122984

099064

# Slem

Montatura in metallo con finitura in bianco, cromo o nickel satinato. Corpo luce posizionabile con rotazione dello stelo e snodo per l'inclinazione.

 Lampadine ALO GU10 28W 2700 K incluse.

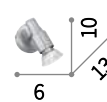
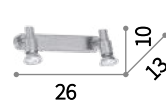
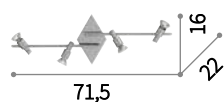

GU10 max 4 x 50W

142098 PL4 Bianco  
142067 PL4 Cromo  
018850 PL4 Nickel



GU10 max 2 x 50W

142081 AP2 Bianco  
142050 AP2 Cromo  
018836 AP2 Nickel



GU10 max 1 x 50W

099064 AP1 Bianco  
122984 AP1 Cromo  
018829 AP1 Nickel









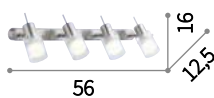



# Elis

Montatura in metallo cromato. Corpo luce orientabile. Diffusore in vetro pirex trasparente e smerigliato a sabbia nella parte centrale.

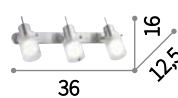





 IP20  
 E14 max 4 x 40W  
 031101 PL4

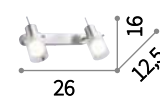





 IP20  
 E14 max 3 x 40W  
 031095 AP3



 IP20  
 E14 max 2 x 40W  
 031088 AP2





 IP20  
 E14 max 1 x 40W  
 031071 AP1









# Nostalgia



Montatura in metallo cromato. Base con lastra in vetro bianco. Diffusori posizionabili in vetro trasparente stampato.

 Lampadine ALO G9 28W 2700 K incluse.







   IP20   
G9 max 4 x 40W  
**077963 PL4**

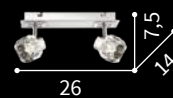

   IP20   
G9 max 3 x 40W  
**077956 AP3**



   IP20   
G9 max 2 x 40W  
**077949 AP2**

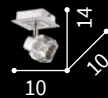

   IP20   
G9 max 1 x 40W  
**077932 AP1**



# Soffio

Montatura in metallo cromato. Corpo luce posizionabile. Diffusore in vetro soffiato variegato bianco e acidato.



Lampadine ALO G9 28W 2700 K incluse.

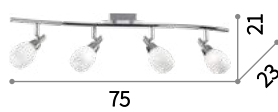









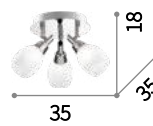







  
 G9 max 4 x 40W  
 075082 PL4

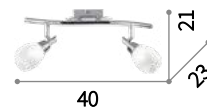





  
 G9 max 3 x 40W  
 075075 AP3

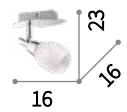





  
 G9 max 2 x 40W  
 075051 AP2







  
 G9 max 1 x 40W  
 075044 AP1

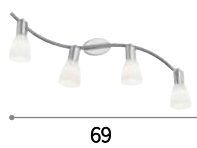

# Snake

Montatura in metallo cromato. Corpo luce posizionabile. Diffusore in vetro bianco soffiato e acidato.



⊙ ⊖ ⊕ IP20

E14 max 4 x 40W  
002781 PL4

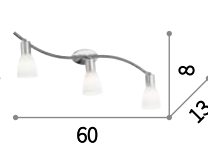

⊙ ⊖ ⊕ IP20

E14 max 3 x 40W  
002774 AP3

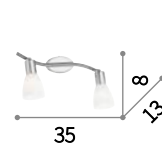

⊙ ⊖ ⊕ IP20

E14 max 2 x 40W  
002767 AP2



⊙ ⊖ ⊕ IP20

E14 max 1 x 40W  
002705 AP1

# Tavolo e terra







# Dorsale

Montatura in metallo rifinito in cromo o con vernice opaca bianca o nera. Braccio a sezione quadrata composto da tre elementi. Paralume in lamina di PVC, disponibile in colore cromo o rivestita in tessuto bianco o nero.

**ON**  
**OFF** Lampada con interruttore integrato.

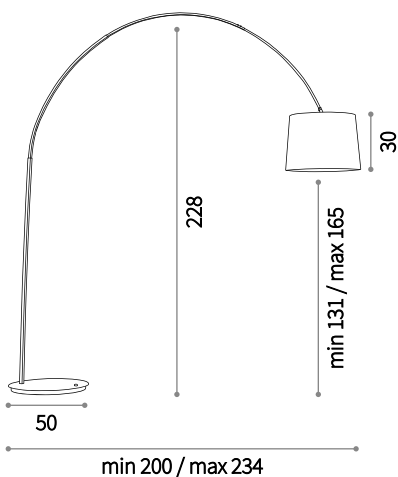

♀ □ IP20

E27 max 1 x 60W

012605 PT1 Bianco  
005126 PT1 Cromo  
014371 PT1 Nero  
091983 PT1 Total Black  
095127 PT1 Total White



095127

091983



# Daddy

Montatura in metallo. Disponibile in nero e bianco opaco con paralume rivestito in tessuto o in cromo con paralume in lamina di pvc cromata semitrasparente.

 Lampada con interruttore integrato.

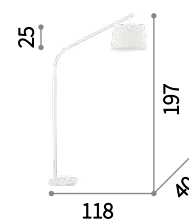

  IP20

E27 max 1x60W

110356 PT1 Bianco  
110370 PT1 Cromo  
110363 PT1 Nero





110363

# Colonna

Montatura in metallo cromato o verniciato opaco. Diffusore in acrilico. Cavo in tessuto. Lampadine a LED sostituibili.

**LED** Lampadine LED GX53 9,5W 3000 K incluse. Cod. 123936

**ON OFF** Lampada con interruttore integrato.

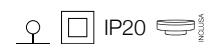
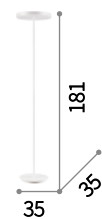
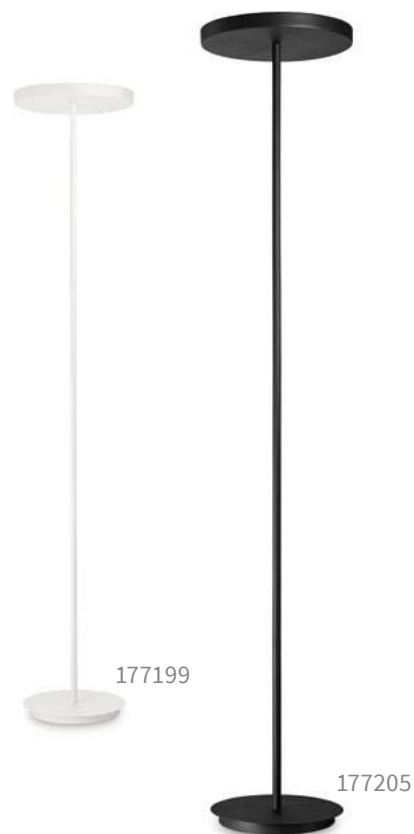

GX53 max 4 x 15W

177199 PT4 Bianco  
177212 PT4 Cromo  
177205 PT4 Nero



177212





# London

Montatura in metallo rifinito in ottone o con vernice opaca bianca o nera.  
Paralume in lamina di PVC rivestito di tessuto.



 Lampada con interruttore integrato.



  IP20  
E27 max 1x60W



110448 TL1 Big Bianco  
110455 TL1 Big Nero  
110479 TL1 Big Ottone

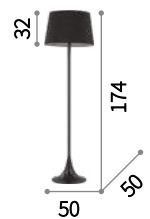

  IP20  
E27 max 1x60W

110530 TL1 Small Bianco  
110554 TL1 Small Nero  
110578 TL1 Small Ottone



  IP20  
E27 max 1x100W

110233 PT1 Bianco  
110240 PT1 Nero  
110257 PT1 Ottone





# Stage

Corpo luce in metallo rifinito con vernice nera opaca. Treppiede con asta telescopica regolabile in altezza. Diffusore orientabile, decorato internamente in foglia argento o in foglia oro.

 Lampada con interruttore integrato.

132778



132785

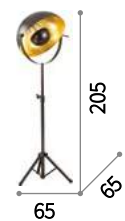

  IP20

E27 max 1 x 60W

132785 PT1 Foglia Argento  
132778 PT1 Foglia Oro





# Movie

Montatura interamente in metallo verniciato nero opaco. Diffusore orientabile con alette mobili per la regolazione del flusso luminoso.

**ON** Lampada con interruttore integrato  
**OFF** nel modello PT1.

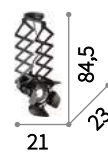

⊕ ⊖ IP20  
E27 max 1 x 60W  
155500 PL1



♀ ⊞ IP20  
E27 max 1 x 60W  
138527 PT1





# Pagoda

Montatura e base in metallo rifinito con smalto satinato. Paralume a inclinazione regolabile rivestito di tessuto.

 Lampada con interruttore integrato.

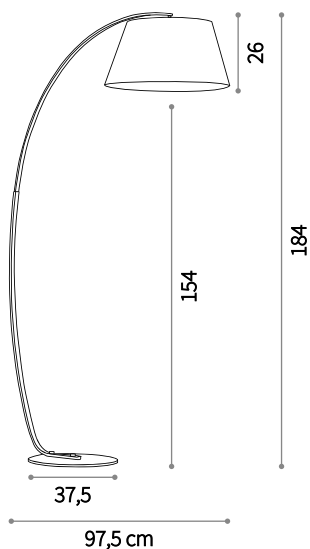

  IP20

E27 max 1x60W

062273 PT1 Argento  
051741 PT1 Bianco  
051765 PT1 Nero





051765





# Eminent

Montatura in metallo verniciato a polveri.  
 Base con elemento in legno naturale.  
 Paralume in pvc rivestito di tessuto.  
 Interruttore su cavo di alimentazione.

**ON**  
**OFF** Lampada con interruttore integrato.



♀ □ IP20  
 E27 max 1x60W  
 207582 PT1





145365

# Piano

Montatura e diffusore in metallo rifinito con vernice opaca. Tavolino di supporto in legno naturale tornito.

**ON** **OFF** Lampada con interruttore integrato.



138282

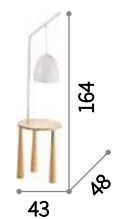

♀ □ IP20

E27 max 1x60W

138282 PT1 Bianco  
145365 PT1 Nero

# Futura

Braccio in alluminio e plastica, snodato con cavo a vista in pvc. Diffusore orientabile a led e interruttore incorporato. Spina con alimentatore.

**LED** Sorgente luminosa LED 4000 K, 25.000 h di durata.

**ON OFF** Lampada con interruttore integrato.

**+** Lampada con dimmer.

**Hand** Lampada con dimmer tattile.

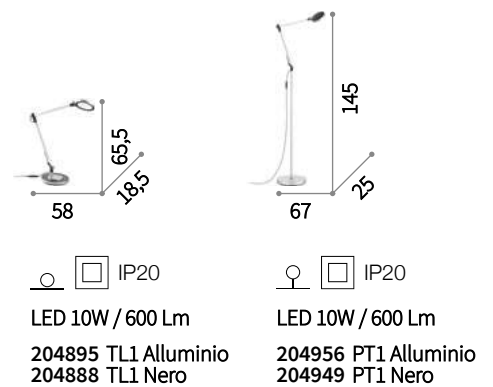



204888



# Polly

Diffusori e base in metallo cromato o smaltato. Dettagli e raccordi in metallo cromato. Diffusori orientabili.

 Lampada con interruttore integrato.

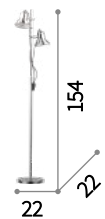

  IP20

E27 max 2 x 60W

061115 PT2 Argento  
061122 PT2 Cromo  
061139 PT2 Nero







# Kelly

Lampada tecnica in metallo con finitura bianco o nero opaco. Braccio snodato e bilanciato a molle. Diffusore orientabile.

**ON**  
**OFF** Lampada con interruttore integrato.

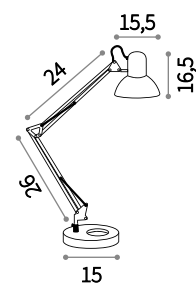

IP20

max 1 x 42W E27



108117 TL1 Bianco  
108094 TL1 Nero

# Wally

Lampada tecnica in metallo con finitura nero opaco. Braccio snodato e bilanciato a molle. Diffusore orientabile.

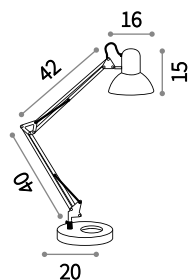
 Lampada con interruttore integrato.



  IP20  
max 1 x 42W E27  
061191 TL1





# Sally

Lampada tecnica in metallo con finitura nero opaco. Braccio snodato e bilanciato a molle. Diffusore orientabile.

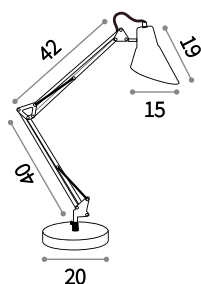
 Lampada con interruttore integrato.



  IP20  
max 1 x 42W E27  
061160 TL1





# Air

Diffusori e base in metallo cromato o smaltato. Dettagli e raccordi in metallo cromato. Diffusori orientabili.

**LED** Sorgente luminosa LED 3000 K, 20.000 h di durata.

**ON OFF** Lampada con interruttore integrato.



○ □ IP20

LED 10W / 720 Lm

207766 TL24 Bianco  
207780 TL24 Nero





# Gru

Montatura interamente in metallo. Asta con finitura in cromo. Base e diffusore con finitura in alluminio anodizzato o in vernice opaca bianca o nera. Diffusore ruotabile e regolabile in altezza.

**LED** Sorgente luminosa LED 3000 K, 15.000 h di durata.

**ON/OFF** Lampada con interruttore integrato.

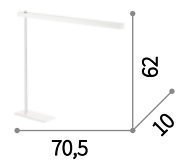

○ □ IP20

LED 6,3W / 400 Lm

147635 TL105 Alluminio  
147642 TL105 Bianco  
147659 TL105 Nero



# Regol

Montatura snodata in metallo. Diffusore regolabile ad altezze diverse. Disponibile con finitura nickel satinato e paralume rivestito in tessuto bianco o con finitura cromo e paralume in PVC cromato.

**ON**  
**OFF** Lampada con interruttore integrato.



○ □ IP20  
E27 max 1 x 60W

014616 TL1 Bianco  
019772 TL1 Cromo



○ □ IP20  
E27 max 1 x 60W

014609 PT1 Bianco



# Stand Up

Montatura in metallo con finitura in cromo. Diffusore in vetro pirex smerigliato nella parte centrale.



Lampadine ALO R7s 120W 118 mm 2700 K incluse.



Lampada con interruttore integrato.



Pila AP1  
Pag. 314

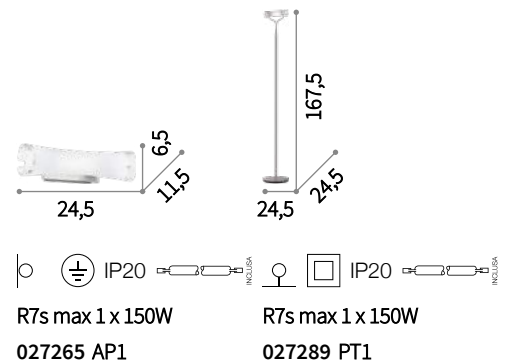

# Fit

Base in metallo verniciato opaco.  
Paralume con tessuto naturale  
intercambiabile e lavabile. Due tessuti  
inclusi: bianco/nero e canvas.

 Lampada con interruttore integrato.

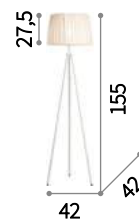
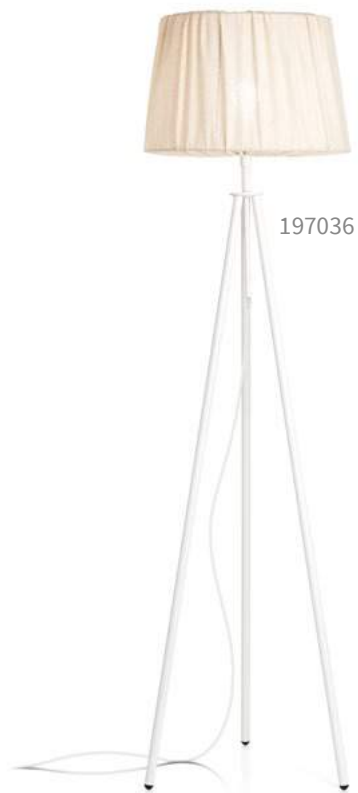

  IP20

E27 max 1x60W

197036 PT1 Bianco  
220963 PT1 Nero





220963





# Tridente

Treppiede in legno naturale. Paralume in lamina di pvc rivestita in tessuto e con supporto in metallo con finitura nickel satinato.

**ON**  
**OFF** Lampada con interruttore integrato.



♀ □ IP20  
E27 max 1x60W  
146317 PT1



# Klimt

Treppiede in legno naturale. Paralume in lamina di pvc rivestita in tessuto e con supporto in metallo cromato.

**ON** / **OFF** Lampada con interruttore integrato.

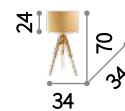

○ □ IP20  
E27 max 1 x 60W  
137841 TL1

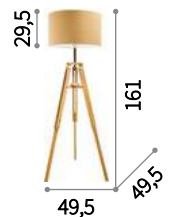



○ □ IP20  
E27 max 1 x 60W  
137827 PT1

# York

Base in legno naturale con dettagli in metallo. Paralume in lamina di pvc rivestito in tessuto bianco. Cavo esterno in tessuto. Disponibile anche con montatura e paralume bianchi o neri.

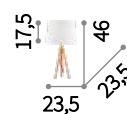

 Lampada con interruttore integrato.



  IP20  
E27 max 1 x 60W

121376 TL1 Bianco  
121413 TL1 Nero  
089782 TL1 Wood



  IP20  
E27 max 1 x 60W

121406 PT1 Bianco  
121437 PT1 Nero  
089805 PT1 Wood







# Touch

Corpo luce in metallo rifinito in cromo o smaltato bianco. Interruttore touch: si accende e si regola l'intensità col tocco di un dito sul corpo luce.

**LED** Lampadine LED E27 8W Globo D125 trasparente 3000 K incluse. Cod. 101347

**ON OFF** Lampada con interruttore integrato.

**+** Lampada con dimmer.

**Hand icon** Lampada con dimmer tattile.



IP20 **Touch** **LED**

E27 max 1x60W

046334 TL1 Bianco  
046341 TL1 Cromo





# Kool Table

Corpo luce interamente in vero cemento  
con supporto metallico interno.

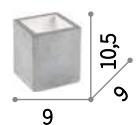
 Lampada con interruttore integrato.



  IP20  
G9 max 1 x 15W  
141282 TL1





# Birillo

Lampada da tavolo o da terra con base in metallo cromato e diffusore in vetro soffiato bianco e acidato o fumè.

**ON**  
**OFF** Lampada con interruttore integrato.

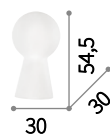

○ ♀ □ IP20  
E27 max 1x60W

000275 TL1 Big Bianco  
116594 TL1 Big Fumè



○ ♀ □ IP20  
E27 max 1x60W

000251 TL1 Medium Bianco  
116587 TL1 Medium Fumè

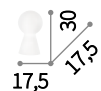

○ ♀ □ IP20  
E27 max 1x60W

000268 TL1 Small Bianco  
116570 TL1 Small Fumè





194448

# Cupcake

Base in resina smaltata. Diffusore in vetro bianco soffiato e acidato. Cavo di alimentazione con interruttore.

**ON**  
**OFF** Lampada con interruttore integrato.



IP20

E27 max 1x60W

194417 TL1 Bianco  
194424 TL1 Cromo  
194448 TL1 Rosa



# Studio

Montatura in metallo. Diffusore in vetro soffiato incamiciato. Accensione e regolazione di intensità con dispositivo touch attivo su tutta la montatura.



Lampadine ALO G9 28W 2700 K incluse.



Lampada con interruttore integrato.



Lampada con dimmer.



Lampada con dimmer tattile.

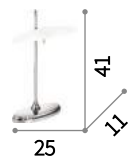

G9 max 2 x 28W

010069 TL2



# Edo

Montatura interna in metallo cromato.  
Diffusore in vetro bianco soffiato,  
incamiciato e acidato.

**ON**  
**OFF** Lampada con interruttore integrato.



○ □ IP20  
E27 max 1 x 60W  
044590 TL1 Big



○ □ IP20  
E27 max 1 x 60W  
044606 TL1 Small







# Prato

Diffusore in vetro soffiato bianco incamiciato e acidato.





Lampada con interruttore integrato.

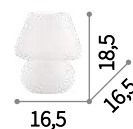

  IP20  
E27 max 1 x 60W  
074702 TL1 Big



  IP20  
E14 max 1 x 40W  
074726 TL1 Small







# Fungo

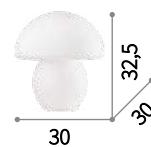

Montatura in metallo smaltato bianco opaco. Corpo luce-diffusore in vetro soffiato bianco acidato.

 Lampada con interruttore integrato.

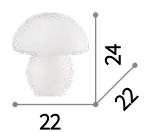

  IP20  
E27 max 1 x 60W  
142630 TL1 Big



  IP20  
E27 max 1 x 60W  
142647 TL1 Small

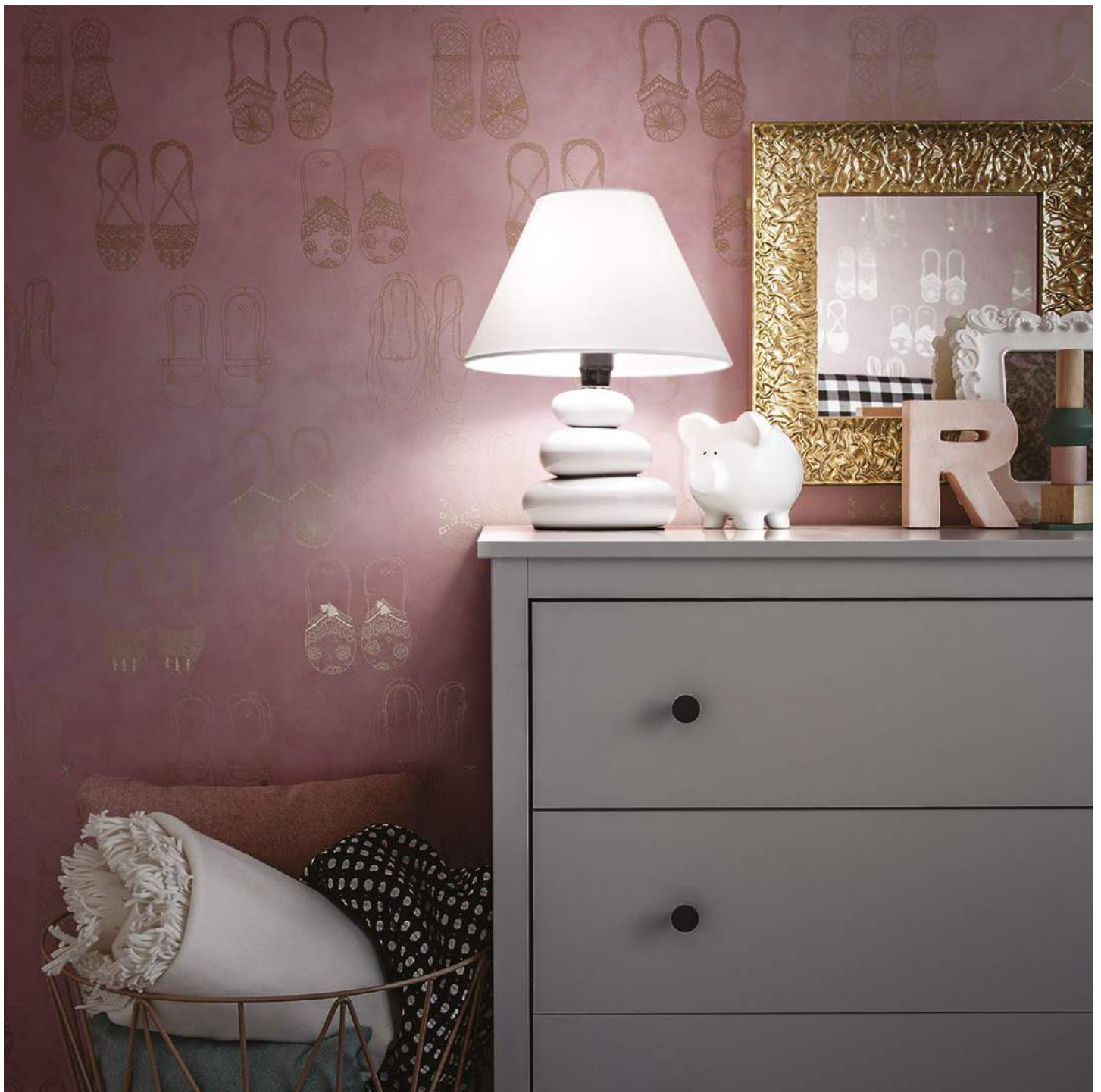

## K2

Corpo luce con elementi in ceramica smaltati. Paralume in lamina di PVC rivestita di tessuto.

**ON** **OFF** Lampada con interruttore integrato.



○ □ IP20

E14 max 1x 40W

035093 TL1 Bianco  
035031 TL1 Blu





# Desiree

Montatura e base in metallo cromato.  
Paralume in lamina di PVC rivestita in  
tessuto.

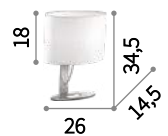
 Lampada con interruttore integrato.



  IP20  
E14 max 1x 40W  
074870 TL1



# Classico

## Coordinati e sospensioni









# Copernico

Montatura in metallo verniciato opaco con dettagli in ottone. Diffusori in vetro incamiciato bianco soffiato e acidato.

**LED** Lampadine LED G9 3,2W 3000 K incluse. Cod. 209043

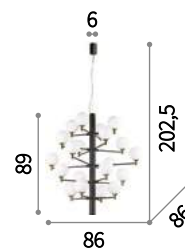

G9 max 20 x 40W

197326 SP20 Bianco  
197333 SP20 Nero

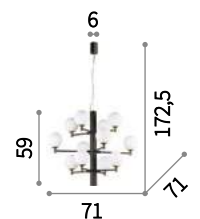

G9 max 12 x 40W

197302 SP12 Bianco  
197319 SP12 Nero





197333





200118

# Equinoxe

Montatura a bracci in metallo con finitura cromo o ottone antico. Diffusori in vetro soffiato trasparente.

**LED** Lampadine LED G4 2W 3000 K incluse. Cod. 222257

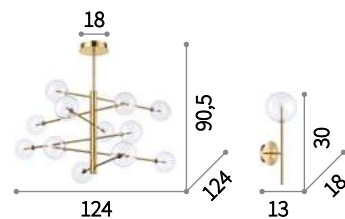

⌀ 18  
⊕ IP20

G4 max 12 x 2W

200118 SP12 Cromo

200125 SP12 Ottone Antico

⌀ 18  
⊕ IP20

G4 max 1 x 2W

200132 AP1 Cromo

200149 AP1 Ottone Antico





200125



# Abc

Rosone, copri portalamapade e struttura decorativa interamente in metallo rifinito ottone satinato. Cavo in tessuto nero.

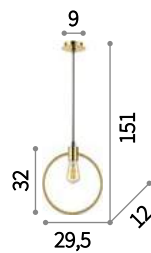

⊕ ⊖ IP20

E27 max 1 x 70W  
207841 SP1 Round

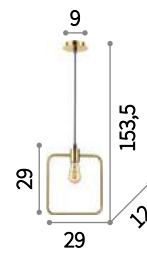

⊕ ⊖ IP20

E27 max 1 x 70W  
207858 SP1 Square

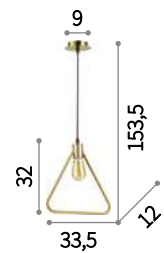

⊕ ⊖ IP20

E27 max 1 x 70W  
207834 SP1 Triangle







# Triumph

Montatura interamente in metallo con finitura ottone invecchiato. Modelli AP con cavo in tessuto con interruttore e spina.

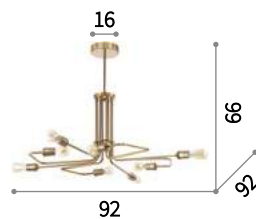

⊕ ⊖ IP20

E27 max 8 x 60W  
160269 SP8

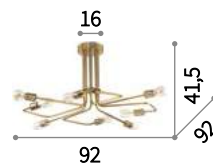

⊕ ⊖ IP20

E27 max 8 x 60W  
160313 PL8

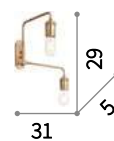

⊕ ⊖ IP20

E27 max 2 x 60W  
160245 AP2

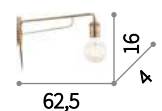

⊕ ⊖ IP20

E27 max 1 x 60W  
160214 AP1











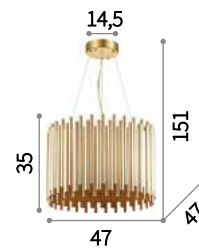

# Pan

Montatura in metallo. Diffusori con elementi decorativi a tubi metallici di diverse misure. Cavi d'acciaio regolabili.

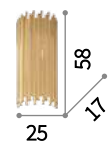

 IP20  
 E27 max 5 x 60W  
 208817 SP5





 IP20  
 E14 max 2 x 40W  
 208794 AP2

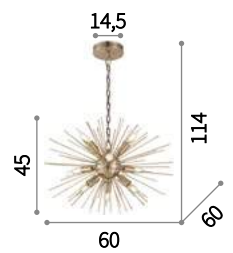

# Kiss

Rosone, elemento centrale con portalampane e aste decorative interamente in metallo con finitura ottone satinato.



⊕ □ IP20

E14 max 9x 40W

201368 SP9



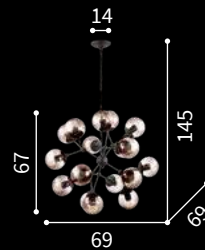

# Kepler

Catena e montatura in metallo verniciato nero opaco. Diffusori in vetro soffiato trasparente ambrato.



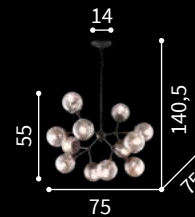

 IP20  
 E27 max 18 x 40W  
**162478 SP18**



 IP20  
 E27 max 12 x 40W  
**162201 SP12**



 IP20  
 E27 max 3 x 40W  
**187006 AP3**







# World

Montatura in metallo. Diffusore in vetro soffiato trasparente. SP4 con paralumi in PVC rivestiti in tessuto. Copricatena in velluto.

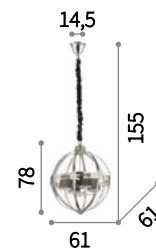

E14 max 4 x 40W  
 156330 SP4 Brunito  
 156347 SP4 Cromo

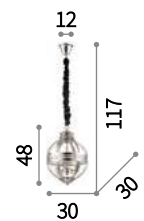

E14 max 3 x 40W  
 156316 SP3 Brunito  
 156323 SP3 Cromo



156347







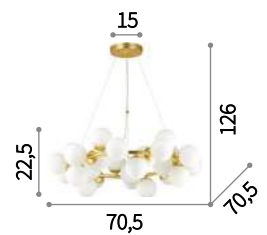

# Dna

Rosone e montatura in metallo dorato.  
 Diffusori in vetro incamiciato bianco,  
 soffiato e acidato. Cavi d'acciaio regolabili.

**LED** Lampadine LED G9 3,2W 3000 K  
 incluse. Cod. 209043



 IP20
 

G9 max 25 x 40W  
 208398 SP25







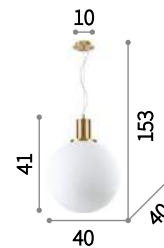

# Loko

Montatura in metallo con finitura ottone satinato. Diffusore in vetro incamiciato bianco, soffiato e acidato.

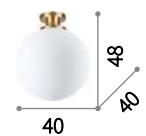

 IP20  
 E27 max 1 x 60W  
 197920 SP1



 IP20  
 E27 max 1 x 60W  
 197944 PL1



# Bistrò

Montatura in metallo verniciato nero.  
 Diffusore in vetro, ambra, trasparente o  
 fumè, soffiato e modellato artigianalmente.



⊕ ⊖ IP20

E27 max 1 x 60W

163772 SP1RoundAmbra

120904 SP1RoundFumè

120898 SP1RoundTrasparente

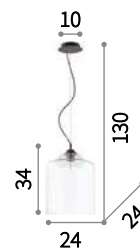

⊕ ⊖ IP20

E27 max 1 x 60W

163789 SP1SquareAmbra

112312 SP1SquareFumè

112305 SP1SquareTrasparente



⊕ ⊖ IP20

E27 max 1 x 60W

112343 SP1PlateFumè

112336 SP1PlateTrasparente





# Hansel

Montatura in metallo verniciato nero opaco con inserto in corda. Diffusore in vetro trasparente ambrato con bordi nero opaco.



⊕ ⊖ IP20

E27 max 1x60W  
168579 SP1 Round



⊕ ⊖ IP20

E27 max 1x60W  
168609 SP1 Oval

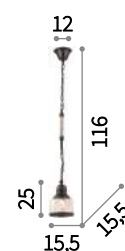

⊕ ⊖ IP20

E27 max 1x60W  
168586 SP1 Square





# Gretel

Montatura in metallo rifinito in vernice nera opaca con applicazione in legno naturale. Diffusori in vetro soffiato trasparente. Cavi in tessuto nero.



⊕ ⊖ IP20

E27 max 5 x 60W

103174 SP5

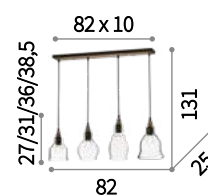

⊕ ⊖ IP20

E27 max 4 x 60W

122557 SP4

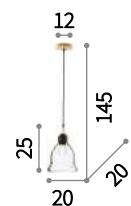

⊕ ⊖ IP20

E27 max 1 x 60W

122564 SP1

# Rustik

Rosone in metallo nero opaco. Cavo in tessuto. Portalampade in metallo brunito. Diffusore in vetro soffiato trasparente effetto fumè.



⏏ ⏏ IP20

E27 max 1 x 60W

198071 SP1



# Blob

Montatura in metallo. Cavo in tessuto. Diffusore in vetro soffiato trasparente con finitura fumè o ambra.



⏏ ⏏ IP20

E27 max 1 x 42W

207988 SP1 Ambra  
207995 SP1 Fumè







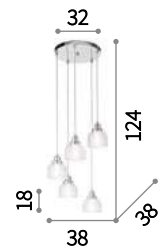

# Ruby

Montatura in metallo cromato. Diffusore in vetro trasparente con decoro in rilievo. Cavo trasparente intrecciato.



 IP20  
 E14 max 5 x 40W  
 153100 SP5



092850



149684



# Igor

Montatura in metallo con finitura opaca bianca o nera. Diffusore con lastre di vetro trasparente.

**ON**  
**OFF** Lampada con interruttore integrato nel modello PT8.

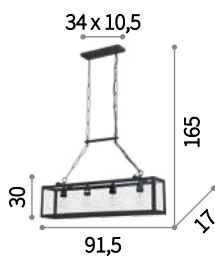

⊕ ⊖ IP20  
E27 max 4 x 60W  
092942 SP4 Nero



⊕ ⊖ IP20  
E27 max 3 x 60W  
092881 SP3 Nero

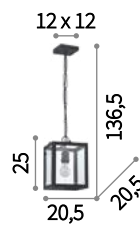

⊕ ⊖ IP20  
E27 max 1 x 60W  
092850 SP1 Nero

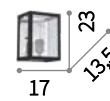

⊕ ⊖ IP20  
E27 max 1 x 60W  
149684 AP1 Bianco  
092836 AP1 Nero

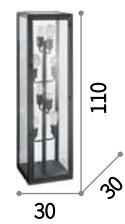

⊕ ⊖ IP20  
E27 max 8 x 52W  
187389 PT8 Nero







# Plumber

Montatura con elementi idraulici in metallo. Finiture: nero opaco o nero antichizzato. Modello SP1 con cavo in tessuto intrecciato.

**ON** Lampada con interruttore integrato  
**OFF** nel modello PT1.



136738

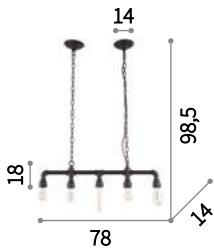

⊕ ⊖ IP20

E27 max 5 x 60W

136738 SP5 Nero  
175355 SP5 Vintage



175355



⊕ ⊖ IP20

E27 max 1 x 60W

155906 SP1 Nero  
187716 SP1 Vintage

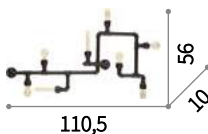

⊕ ⊖ IP20

E27 max 8 x 42W

136714 PL8 Nero  
175331 PL8 Vintage

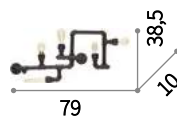

⊕ ⊖ IP20

E27 max 5 x 42W

136707 PL5 Nero  
175324 PL5 Vintage

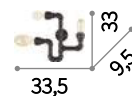

⊕ ⊖ IP20

E27 max 3 x 42W

142517 AP3 Nero  
175317 AP3 Vintage

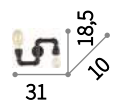

⊕ ⊖ IP20

E27 max 2 x 42W

136691 AP2 Nero



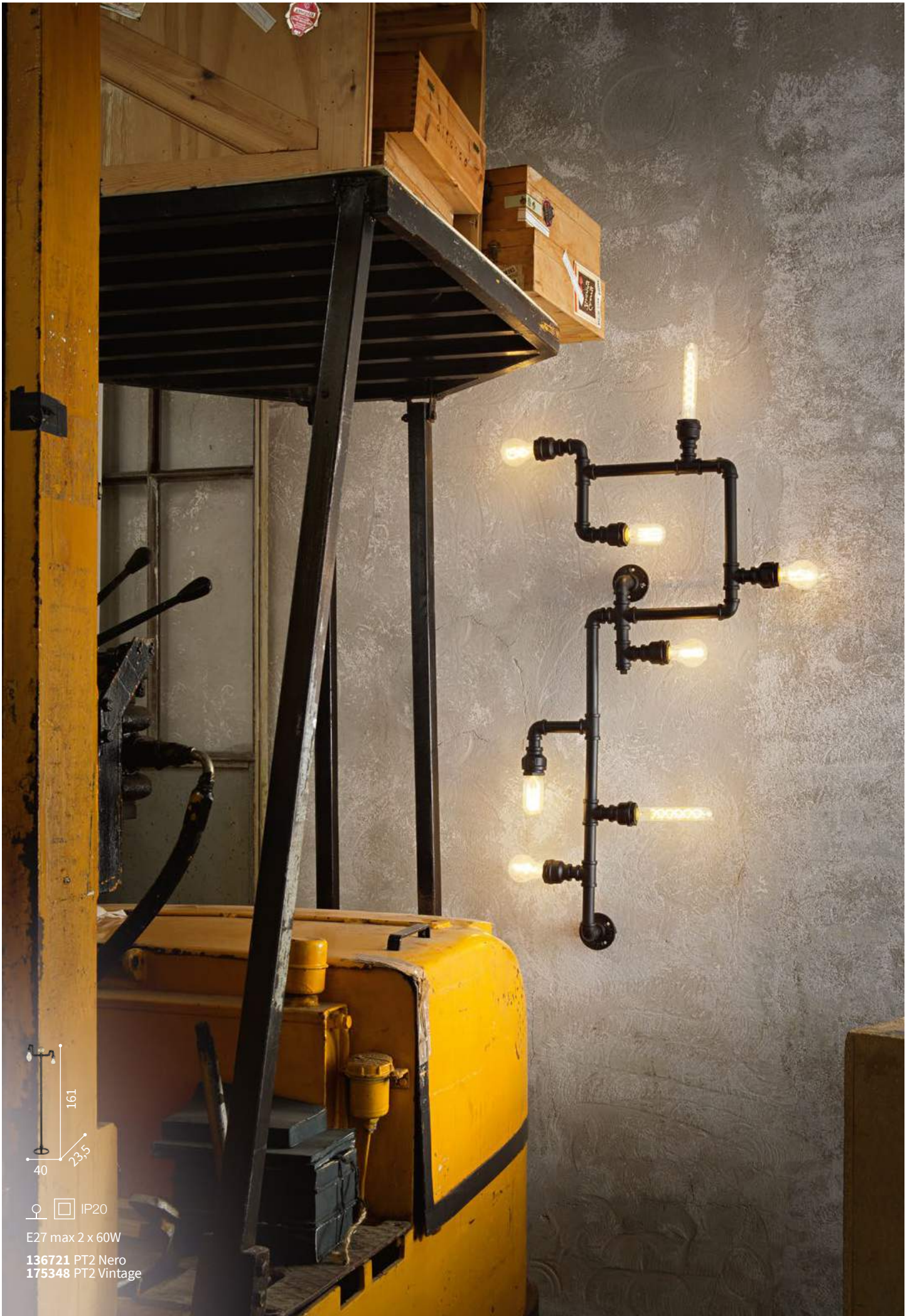

IP20

E27 max 2 x 60W

136721 PT2 Nero  
175348 PT2 Vintage







# Cesto

Montatura e diffusore interamente in metallo modellato artigianalmente con finitura grezza. Cavo in tessuto.



⊕ ⊞ IP20

E27 max 1x60W

162416 SP1





# Saloon

Rosone in metallo con finitura bronzo.  
Cavi elettrici in tessuto. Paralume  
in metallo rifinito nickel, lavorato e  
antichizzato a mano.

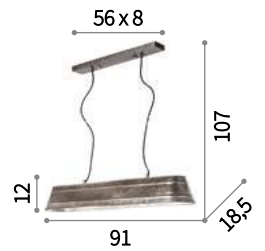

⊕ ⊖ IP20

E27 max 4 x 60W

195872 SP4



# Citrus

Rosone in legno naturale. Corpo luce con elementi in multistrato di legno verniciato. Cavo in tessuto nero.

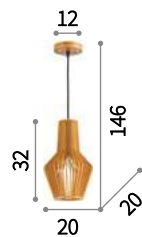

⊕ ⊞ IP20

E27 max 1x60W

159843 Citrus-1 SP1

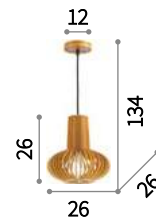

⊕ ⊞ IP20

E27 max 1x60W

159850 Citrus-2 SP1

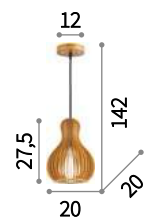

⊕ ⊞ IP20

E27 max 1x60W

159867 Citrus-3 SP1



# Electric

Montatura in metallo rifinito corten. Cavo in tessuto. Portalampane in ceramica smaltata. Cavi in acciaio a lunghezza regolabile.

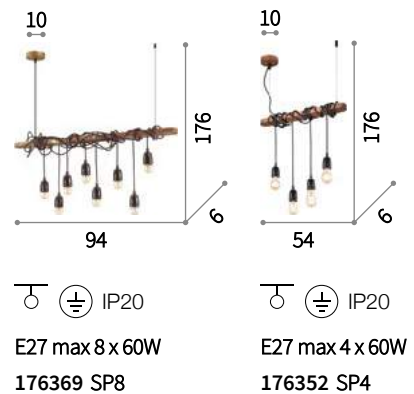



# Lingotto

Montatura in metallo verniciato: base nera opaca e telaio ottone opaco. Diffusori in vetro incamiciato bianco, soffiato e acidato.

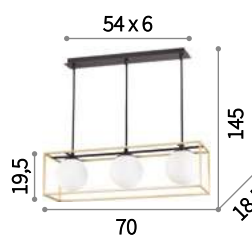

E14 max 3 x 40W  
198125 SP3



E14 max 4 x 40W  
198156 PL4

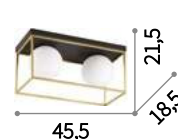

E14 max 2 x 40W  
198149 PL2

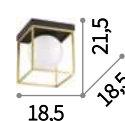

E14 max 1 x 40W  
198132 PL1







# Volt

Montatura interamente in metallo con finitura rame. Sospensione con cavo elettrico regolabile in lunghezza.

**ON**  
**OFF** Lampada con interruttore integrato nel modello TL1.

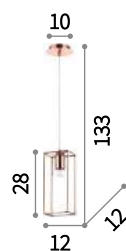

⊕ ⊖ IP20

E27 max 1x60W

137124 SP1

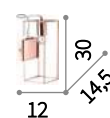

⊕ ⊖ IP20

E27 max 1x60W

137117 AP1

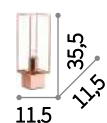

⊕ ⊖ IP20

E27 max 1x60W

137131 TL1







220604

# Clarissa

Rosone, copri portalampane e diffusore interamente in metallo verniciato bianco opaco o rifinito in rame lucido.



220611

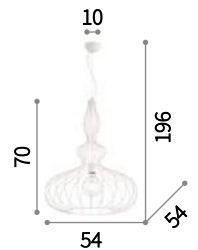

⊕ ⊖ IP20

E27 max 1x8W

220604 SP1 Bianco  
220611 SP1 Rame





# Onion

Montatura interamente in metallo rifinito con vernice marrone a effetto metallico. Cavo in tessuto.



⊕ ⊖ IP20

E27 max 1 x 60W  
205311 SP1 D60



⊕ ⊖ IP20

E27 max 1 x 60W  
205304 SP1 D48



⊕ ⊖ IP20

E27 max 1 x 60W  
205298 SP1 D38



⊕ ⊖ IP20

E27 max 1 x 60W  
205281 SP1 D23



# Ampolla

Rosone porta lampade e struttura decorativa in metallo con varie finiture.  
Cavo elettrico regolabile in lunghezza.

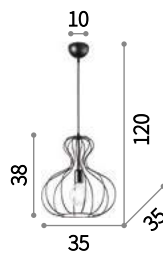

⊕ ⊖ IP20

E27 max 1 x 60W

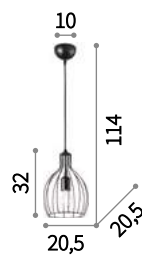

⊕ ⊖ IP20

E27 max 1 x 60W

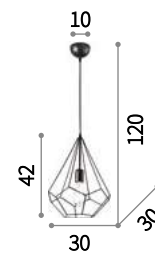

⊕ ⊖ IP20

E27 max 1 x 60W

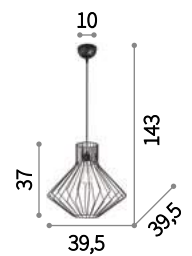

⊕ ⊖ IP20

E27 max 1 x 60W

194295 Ampolla-1SP1.Bianco 200880 Ampolla-2SP1.Bianco 200897 Ampolla-3SP1.Bianco 200903 Ampolla-4SP1.Bianco  
148502 Ampolla-1SP1.Nero 148151 Ampolla-2SP1.Nero 148175 Ampolla-3SP1.Nero 167497 Ampolla-4SP1.Nero  
166209 Ampolla-1SP1.Rame 167282 Ampolla-2SP1.Rame 167367 Ampolla-3SP1.Rame 167503 Ampolla-4SP1.Rame





148502





# Frida

Rosone e copriportalampada in metallo con finiture varie. Cavo in tessuto nero. Disponibile con diffusore in vetro.

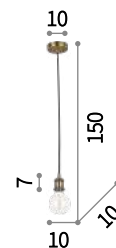

⊕ ⊖ IP20

⊕ ⊖ IP20

E27 max 1 x 60W

E27 max 1 x 60W

122083 SP1 Brunito  
 139432 SP1 Cromo  
 139425 SP1 Nero  
 122106 SP1 Rame Antico

163321 AP1 Brunito  
 163338 AP1 Rame Antico





# Doc

Rosone e copriportalampada in metallo con finiture varie. Cavo in tessuto nero. Interruttore incorporato al portalampade.

**ON**  
**OFF** Lampada con interruttore integrato.

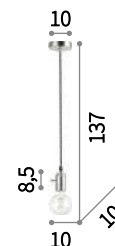

⊕ IP20

E27 max 1x60W

- 163109 SP1 Brunito
- 163116 SP1 Cromo
- 163154 SP1 Ottone
- 163161 SP1 Piombo
- 163123 SP1 Rame Antico

# Tnt

Montatura con elementi idraulici in metallo rifinito con effetto ghisa. Corpo luce in cemento. Diffusore con gabbia metallica.



⊕ ⊖ IP20

E27 max 1 x 60W

168159 SP1

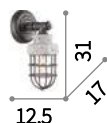

⊕ ⊖ IP20

E27 max 1 x 60W

168180 AP1



# Klaus

Rosone e copri portalampada in ceramica smaltata lucida. Cavo elettrico intrecciato rivestito in tessuto.



⊕ ⊖ IP20

E27 max 1 x 60W

135038 SP1





# Alpen

Rosone elemento decorativo a sfera e copri portalampade in ceramica smaltata, decorata a mano. Cavo in tessuto.

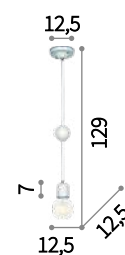

⊕ ⊖ IP20

E27 max 1x 40W

173115 SP1 Azzurro  
173122 SP1 Verde







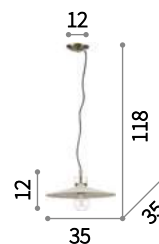

# Brooklyn

Montatura in metallo con finitura in brunito. Diffusore in cemento. Sospensioni con cavo in tessuto nero.



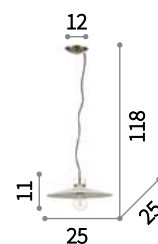

 IP20  
 E27 max 1x60W  
 153445 SP1 D35

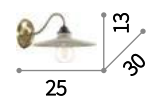

 IP20  
 E27 max 1x60W  
 153438 SP1 D25





 IP20  
 E27 max 1x60W  
 153421 AP1



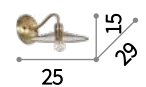
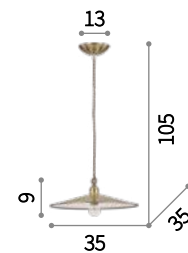

# Cantina

Montatura, diffusore e copriportalampada in metallo disponibile con varie finiture. Cavo elettrico rivestito in tessuto e intrecciato.



⊕ □ IP20

E27 max 1 x 60W

112701 SP1 Brunito  
112732 SP1 Rame

⊕ ⊕ IP20

E14 max 1 x 40W



112626 AP1 Brunito  
112695 AP1 Rame



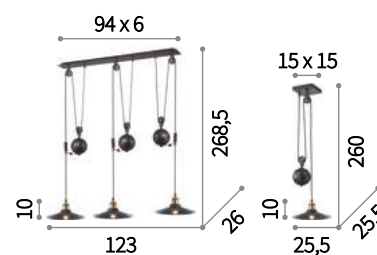

## Up and Down

Montatura in metallo rifinito con vernice nera opaca. Copri portalampade e viti in metallo brunito. Diffusori regolabili in altezza individualmente con sistema a contrappeso.



 IP20  
 E27 max 3 x 60W  
 136349 SP3

 IP20  
 E27 max 1 x 60W  
 136332 SP1





174242



027876

# Newton

Montatura e diffusore in metallo. Disponibile con finitura in nickel satinato, brunito o con vernice nera opaca. Braccio regolabile. Diffusore orientabile smaltato bianco all'interno.

**ON** Lampada con interruttore integrato nei modelli: TL1 e PT1.  
**OFF**



012209

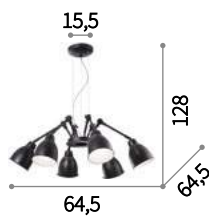

E27 max 6 x 60W  
174242 SP6 Nero

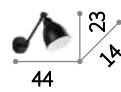

E27 max 1 x 60W  
027876 AP1 Brunito  
027852 AP1 Nero  
016399 AP1 Nickel

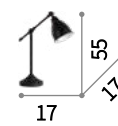

E27 max 1 x 60W  
003535 TL1 Nero  
012209 TL1 Nickel

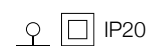
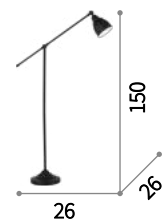

E27 max 1 x 60W  
003528 PT1 Nero  
015286 PT1 Nickel







# Edelweiss

Rosone in metallo verniciato opaco. Cavo in tessuto con portalampane in metallo brunito. Diffusore in ceramica.

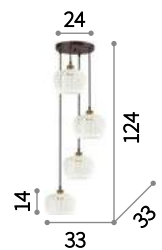

⊕ ⊖ IP20

E27 max 4 x 60W

206790 SP4





# Lugano

Rosone in metallo verniciato opaco. Cavo in tessuto con portalampade in metallo brunito. Diffusore in ceramica.



⊕ ⊖ IP20

E27 max 3 x 60W  
206875 SP3

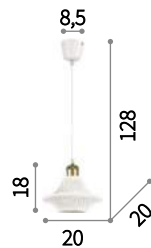

⊕ ⊖ IP20

E27 max 1 x 60W  
206806 SP1 D23

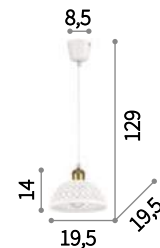

⊕ ⊖ IP20

E27 max 1 x 60W  
206844 SP1 D20



⊕ ⊖ IP20

E27 max 1 x 60W  
206820 SP1 D18



# Triade

Rosone e diffusore in metallo verniciato a polveri con interno bianco. Elemento decorativo a sfera dorato.



⊕ ⊖ IP20

E27 max 3 x 42W

194677 SP3

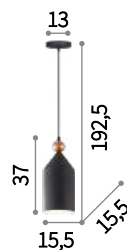

⊕ ⊖ IP20

E27 max 1 x 42W

194684 Triade-1 SP1



⊕ ⊖ IP20

E27 max 1 x 42W

221489 Triade-2 SP1

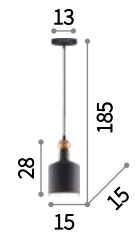

⊕ ⊖ IP20

E27 max 1 x 42W

221496 Triade-3 SP1





166384

## Deda

Rosone e diffusore in ceramica smaltata.  
Montatura centrale in metallo con finitura  
in rame spazzolato e dettagli nero opaco.



166377



⊕ ⊖ IP20

E27 max 1x40W

166377 SP1 Bianco  
166384 SP1 Nero



# Tuly

Rosone e diffusore in metallo rifinito con vernice opaca. Diffusore smaltato bianco all'interno con elemento decorativo in legno.

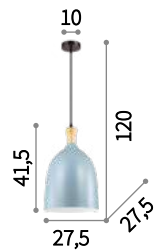

⊕ ⊖ IP20

E27 max 1x60W

134246 SP1



# Mandarin

Montatura e diffusore in metallo. Interno rifinito con smalto bianco. Cavo elettrico regolabile in lunghezza.

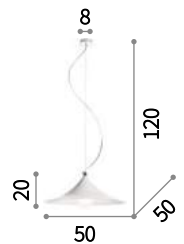

⊕ ⊖ IP20

E27 max 1x60W

087276 SP1





100326

# Hangar

Montatura e diffusore in alluminio anodizzato. Interno smaltato bianco. Cavo elettrico regolabile in lunghezza.



100333



⊕ IP20

E27 max 1x60W

100326 SP1 Alluminio  
100333 SP1 Nero





# Navy

Montatura e diffusore in metallo con varie finiture. Interno smaltato bianco. Cavo elettrico regolabile in lunghezza.

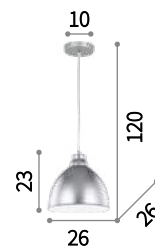

⚡ Ⓧ IP20

E27 max 1x60W

020716 SP1 Alluminio  
 020723 SP1 Brunito  
 020747 SP1 Rame



# Breeze

Montatura e diffusore in metallo. Interno smaltato in bianco. Cavo elettrico regolabile in lunghezza.

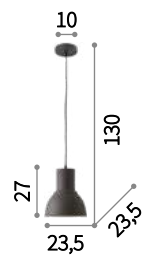

⊕ ⊖ IP20

E27 max 1x60W

137681 SP1



# Metro

Montatura e diffusore in metallo. Interno smaltato in bianco. Cavo elettrico regolabile in lunghezza.

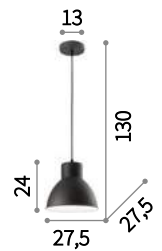

⊕ ⊖ IP20

E27 max 1x60W

139098 SP1



# Moby

Montatura e diffusore in metallo con interno bianco e varie finiture all'esterno.



⚡ Ⓧ IP20

E27 max 1 x 60W

102054 SP1 Alluminio  
102047 SP1 Bianco  
093680 SP1 Cromo  
093659 SP1 Nero  
093697 SP1 Rame





093659





# Fisherman

Corpo luce interamente in metallo con finitura in cromo, rame o in vernice nera opaca. Diffusore in lastra di vetro serigrafato bianco.



⊕ ⊖ IP20

E27 max 1x60W

125824 SP1 Cromo

125831 SP1 Nero

134871 SP1 Rame



# Folk

Rosone e diffusore in metallo decorato con effetto ossidato. Parabola interna ondulata e smaltata bianca. Cavo in tessuto nero.

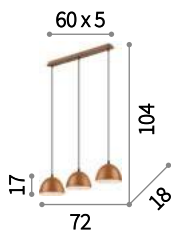

⊕ ⊖ IP20

E27 max 3 x 60W  
174235 SP3

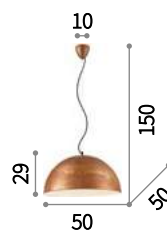

⊕ ⊖ IP20

E27 max 1 x 60W  
174228 SP1 D50

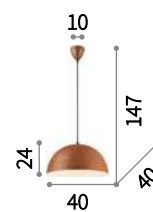

⊕ ⊖ IP20

E27 max 1 x 60W  
174211 SP1 D40

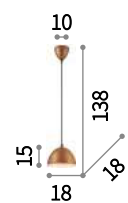

⊕ ⊖ IP20

E27 max 1 x 60W  
174204 SP1 D18





# Sailor

Corpo luce a cupola in metallo con varie finiture e smaltato bianco all'interno. Diffusore in vetro soffiato con effetto rustico.

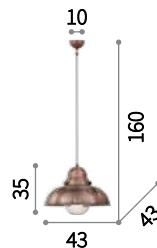

⊕ IP20

E27 max 1x60W

025285 SP1 D43 Brunito  
025315 SP1 D43 Rame

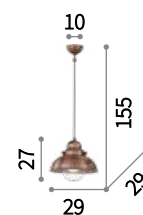

⊕ IP20

E27 max 1x60W

025308 SP1 D29 Brunito  
025278 SP1 D29 Rame

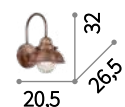

⊕ IP20

E27 max 1x60W

025261 AP1 D20 Brunito  
025292 AP1 D20 Rame



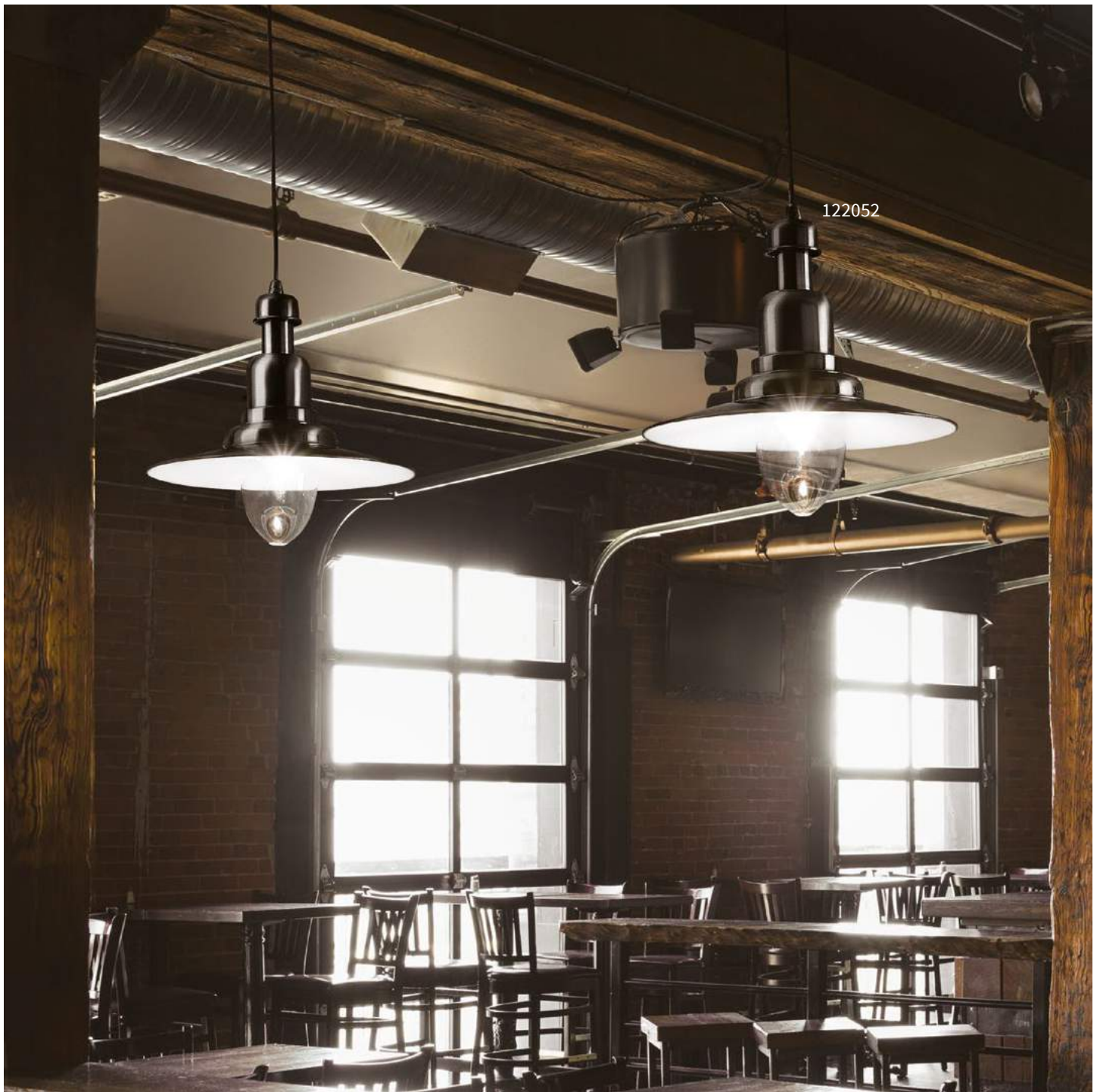

122052

# Fiordi

Corpo luce in metallo, disponibile con finitura in alluminio spazzolato, brunito, rame o smalto nero. Diffusore in vetro trasparente soffiato e rifinito artigianalmente.



022819



005041

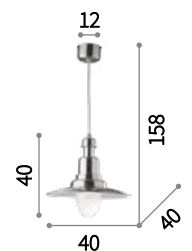

⊕ ⊖ IP20

E27 max 1x60W

022819 SP1 Alluminio

005041 SP1 Brunito

122052 SP1 Nero



# Redentore

Montatura in metallo cromato. Elementi decorativi in vetro soffiato e cristallo molato. Copricatena in velluto.

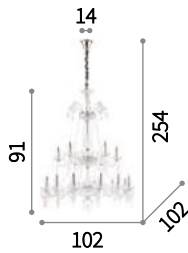

⊕ ⊖ IP20

E14 max 18 x 40W  
176291 SP18

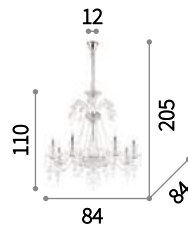

⊕ ⊖ IP20

E14 max 8 x 40W  
187457 SP8

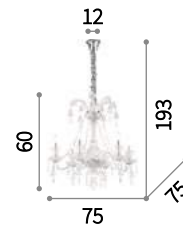

⊕ ⊖ IP20

E14 max 6 x 40W  
187440 SP6

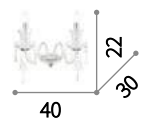

⊕ ⊖ IP20

E14 max 2 x 40W  
187433 AP2







081564



114170

# Colossal

Montatura e dettagli in metallo cromato.  
 Bracci in vetro soffiato trasparente o  
 con interno di colore grigio o bianco  
 avorio. Pendagli ed elementi decorativi  
 in vetro trasparente e cristallo molato.  
 Copricatena in velluto.

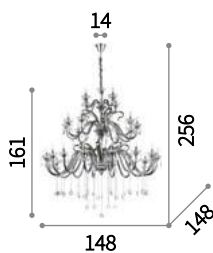

⊕ ⊖ IP20  
 E14 max 30 x 40W  
 183077 SP30 Grigio

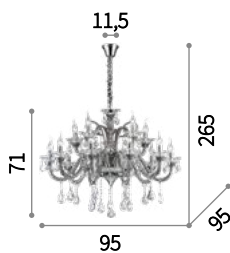

⊕ ⊖ IP20  
 E14 max 15 x 40W  
 081564 SP15 Avorio  
 081526 SP15 Grigio  
 114170 SP15 Trasparente

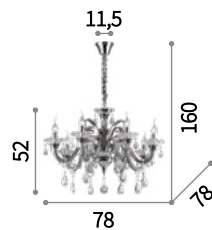

⊕ ⊖ IP20  
 E14 max 8 x 40W  
 081557 SP8 Avorio  
 081519 SP8 Grigio  
 114187 SP8 Trasparente

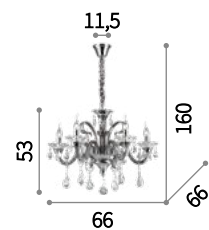

⊕ ⊖ IP20  
 E14 max 6 x 40W  
 081540 SP6 Avorio  
 081502 SP6 Grigio  
 114194 SP6 Trasparente

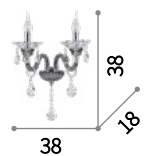

⊕ ⊖ IP20  
 E14 max 2 x 40W  
 081533 AP2 Avorio  
 081496 AP2 Grigio  
 114200 AP2 Trasparente



183077





# Casanova

Lampadario in vetro soffiato e lavorato a mano con copri portalampade e dettagli in metallo cromato. Disponibile trasparente, bianco, multicolor o fumè.

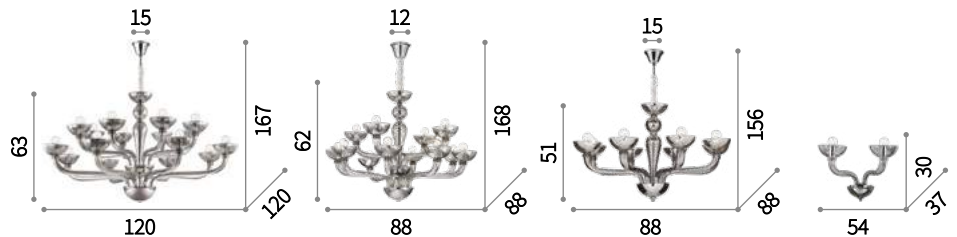

⊕ ⊖ IP20

E14 max 16 x 40W

094120 SP16 Bianco  
104812 SP16 Color  
095639 SP16 Fumè  
044248 SP16 Trasparente

⊕ ⊖ IP20

E14 max 12 x 40W

095622 SP12 Fumè

⊕ ⊖ IP20

E14 max 8 x 40W

094045 SP8 Bianco  
104775 SP8 Color  
095615 SP8 Fumè  
044255 SP8 Trasparente

⊕ ⊖ IP20

E14 max 2 x 40W

116617 AP2 Bianco  
116624 AP2 Fumè  
116600 AP2 Trasparente





104812





# Santa

Lampadario in vetro trasparente soffiato e lavorato a mano. Dettagli in metallo cromato. Copricatena in velluto. Applique disponibile anche con finitura oro e graniglia sul vetro.

087375



087368

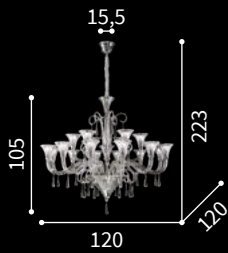
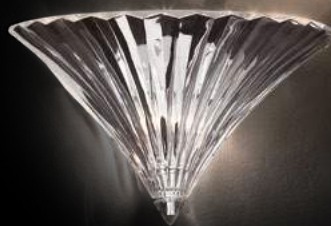

⊕ ⊖ IP20

E14 max 18 x 40W

**142227** SP18Trasparente

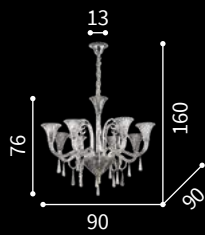

⊕ ⊖ IP20

E14 max 8 x 40W

**103518** SP8Trasparente

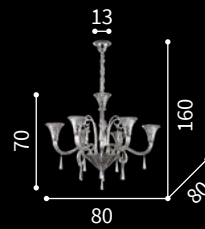

⊕ ⊖ IP20

E14 max 6 x 40W

**103501** SP6Trasparente

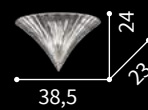

⊕ ⊖ IP20

E14 max 1 x 40W

**087375** AP1BigOro  
**087368** AP1BigTrasparente

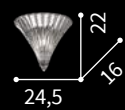

⊕ ⊖ IP20

E14 max 1 x 40W

**013046** AP1SmallOro  
**013060** AP1SmallTrasparente







# Beethoven

Lampadario in vetro trasparente soffiato e lavorato a mano. Montatura e dettagli in metallo rifinito in cromo. Copricatena in velluto.

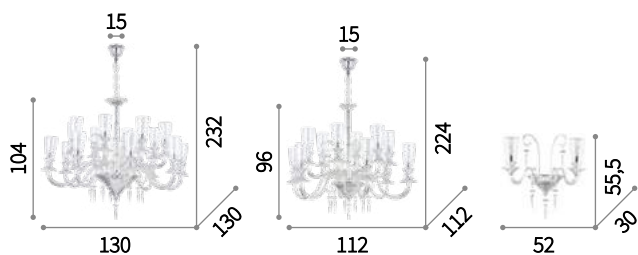

⊕ ⊖ IP20

E14 max 16 x 40W

103426 SP16

⊕ ⊖ IP20

E14 max 12 x 40W

103419 SP12

⊕ ⊖ IP20

E14 max 2 x 40W

103433 AP2









# Baronet

Montatura in metallo dorato. Elementi decorativi in vetro soffiato e cristallo molato. Copricatena in velluto.

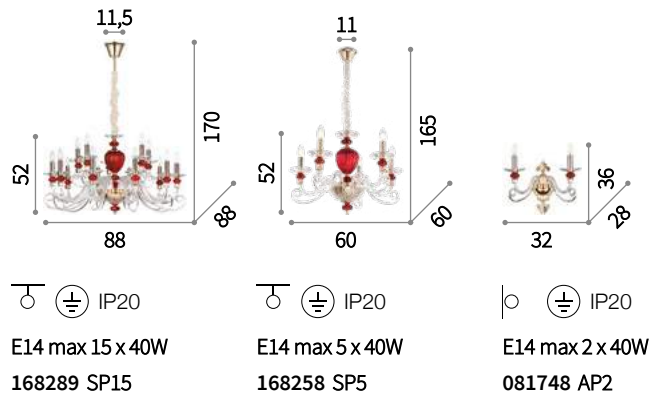









# Strauss

Montatura e dettagli in metallo con finitura oro rosa. Bracci in vetro soffiato trasparente. Elementi decorativi in cristallo ambrato. Copricatena in velluto.





 IP20  
 E14 max 18 x 40W  
**140629** SP18



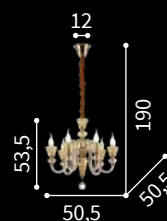

 IP20  
 E14 max 12 x 40W  
**140612** SP12

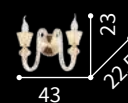

 IP20  
 E14 max 6 x 40W  
**140605** SP6



 IP20  
 E14 max 2 x 40W  
**140599** AP2







# Brigitta

Lampadario in vetro soffiato e lavorato artigianalmente con montatura in metallo e copricatena in velluto.

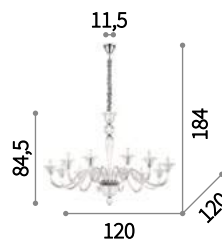

⊕ ⊖ IP20

E14 max 12 x 40W

199405 SP12 Ambra  
199375 SP12 Trasparente

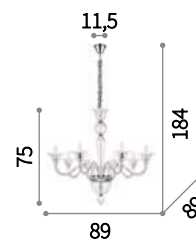

⊕ ⊖ IP20

E14 max 8 x 40W

199412 SP8 Ambra  
199382 SP8 Trasparente

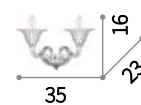

⊕ ⊖ IP20

E14 max 2 x 40W

199429 AP2 Ambra  
199399 AP2 Trasparente





199375





# Danieli

Montatura in metallo cromato o dorato.  
Elementi decorativi in vetro soffiato  
trasparente o ambrato. Copricatena in  
velluto.

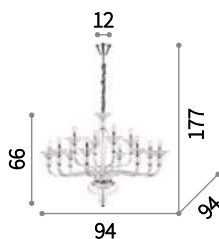

⊕ ⊖ IP20

E14 max 12 x 40W

221373 SP12 Ambra  
213484 SP12 Trasparente

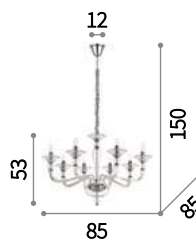

⊕ ⊖ IP20

E14 max 8 x 40W

159973 SP8 Ambra  
159980 SP8 Trasparente

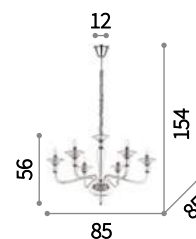

⊕ ⊖ IP20

E14 max 6 x 40W

159942 SP6 Ambra  
159959 SP6 Trasparente

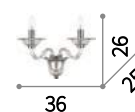

⊕ ⊖ IP20

E14 max 2 x 40W

159935 AP2 Ambra  
159966 AP2 Trasparente



159973







# Doge

Lampadario in vetro, trasparente o bianco, soffiato e lavorato a mano. Montatura e dettagli in metallo rifinito in cromo.

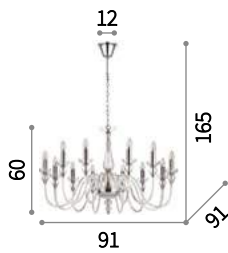

⊕ ⊖ IP20

E14 max 12 x 40W

168906 SP12 Trasparente

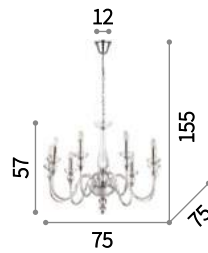

⊕ ⊖ IP20

E14 max 9 x 40W

044453 SP9 Trasparente

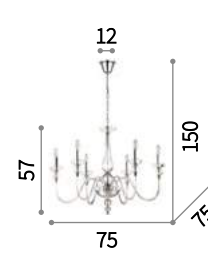

⊕ ⊖ IP20

E14 max 6 x 40W

113678 SP6 Bianco  
044422 SP6 Trasparente

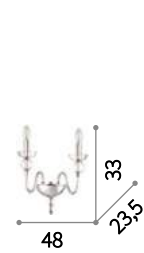

⊕ ⊖ IP20

E14 max 2 x 40W

113654 AP2 Bianco  
044392 AP2 Trasparente



044453





# Negresco

Montatura in metallo con finitura in cromo o dorata. Bracci in vetro soffiato trasparente con interno dorato nella versione oro. Centrale composto da blocchi di cristallo molato. Elementi decorativi in vetro trasparente e cristallo molato. Copricatena in velluto.

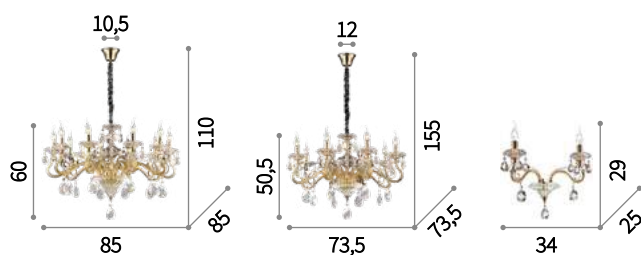

⊕ ⊖ IP20

E14 max 10 x 40W

087771 SP10 Oro  
141060 SP10 Trasparente

⊕ ⊖ IP20

E14 max 8 x 40W

087764 SP8 Oro  
141053 SP8 Trasparente

⊕ ⊖ IP20

E14 max 2 x 40W

087757 AP2 Oro  
141046 AP2 Trasparente



087771









# Rose

Lampadario in vetro soffiato con dettagli in metallo cromato. Ottagoni e gocce in cristallo molato. Copricatena in velluto.

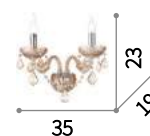

 IP20  
 E14 max 8 x 40W  
 166889 SP8



 IP20  
 E14 max 2 x 40W  
 166841 AP2







# Giudecca

Lampadario in vetro soffiato lavorato a mano con dettagli in metallo cromato. Pendagli con ottagoni e gocce in cristallo molato. Copricatena in velluto.

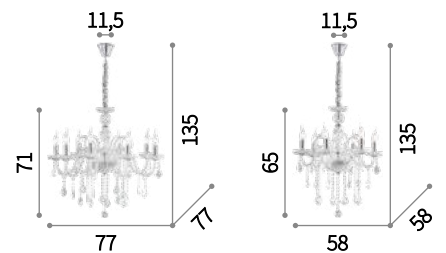

⊕ ⊖ IP20

E14 max 8 x 40W

032511 SP8 Nero  
027425 SP8 Rosso  
027838 SP8 Trasparente

⊕ ⊖ IP20

E14 max 6 x 40W

032504 SP6 Nero  
027418 SP6 Rosso  
027821 SP6 Trasparente





# Miramare

Lampadario in vetro trasparente e bianco soffiato e lavorato a mano. Copri portalampade e dettagli in metallo cromato. Copricatena in velluto.

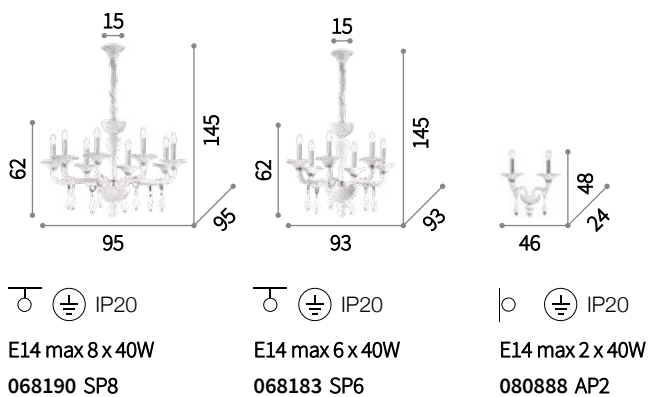







# Continental

Montatura e dettagli in metallo cromato.  
Bracci in vetro soffiato. Pendagli ed elementi decorativi in vetro trasparente e cristallo molato. Copricatena in velluto.

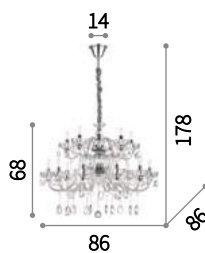

⊖ ⊕ IP20

E14 max 15 x 40W  
207490 SP15

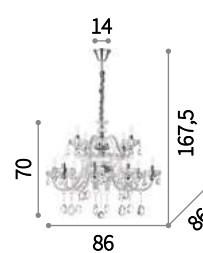

⊖ ⊕ IP20

E14 max 12 x 40W  
207483 SP12

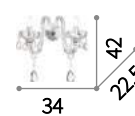

⊖ ⊕ IP20

E14 max 2 x 40W  
207476 AP2







# Camelia

Lampadario in vetro soffiato e lavorato a mano. Montatura in metallo cromato. Bracci trasparenti. Bobeches e coppa centrale disponibili in bianco. Pendagli in cristallo molato trasparente. Cavi in acciaio a lunghezza regolabile da dispositivi automatici.

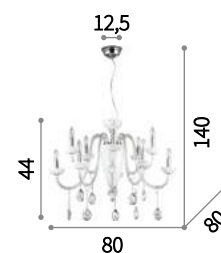

⊕ ⊖ IP20

E14 max 10 x 40W +  
E27 max 1 x 60W

117782 SP11





140339



093987

## Bon Bon

Montatura con bracci in fusione di metallo rifinito con vernice opaca. Bobeche in vetro soffiato nella versione bianca, in metallo in quella nera. Copricatena in velluto.

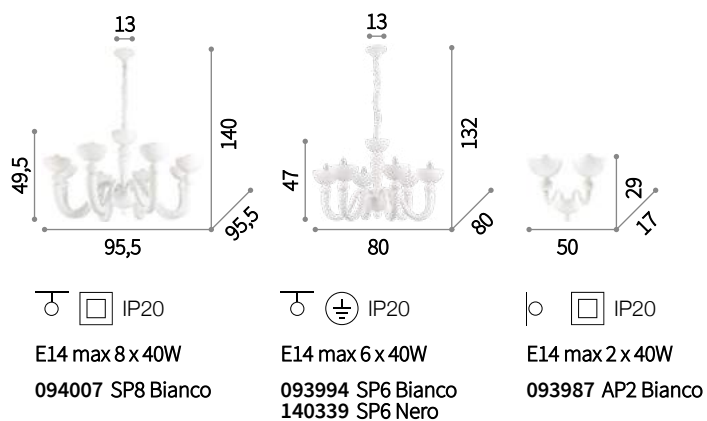









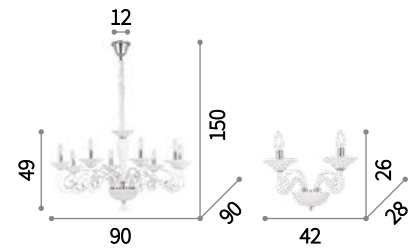

# Maximilian

Lampadario lavorato a mano in vetro colorato bianco. Montatura e dettagli in metallo cromato. Copricatena in velluto.





 IP20  
 E14 max 8 x 40W  
 111490 SP8

 IP20  
 E14 max 2 x 40W  
 111551 AP2

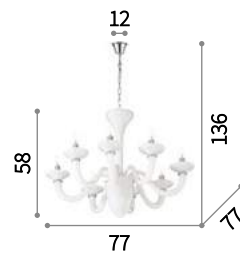

# White Lady

Lampadario in vetro soffiato lavorato a mano con copri portalampane e dettagli in metallo cromato. Copricatena in velluto.



⊕ ⊖ IP20

E14 max 8 x 40W

019390 SP8

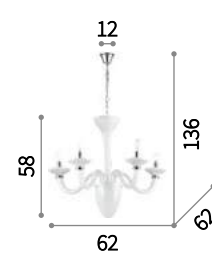

⊕ ⊖ IP20

E14 max 5 x 40W

019383 SP5

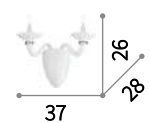

⊕ ⊖ IP20

E14 max 2 x 40W

019376 AP2



073453



# Lilly

Lampadario in vetro soffiato trasparente e colorato lavorato artigianalmente. Dettagli in metallo cromato. Copricatena in velluto.

022789



⊕ ⊖ IP20

E14 max 5 x 40W



022789 SP5 Bianco  
073453 SP5 Rosso



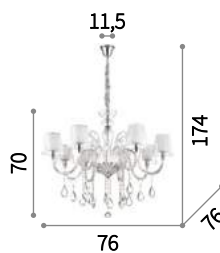

# Terry

Lampadario in vetro trasparente soffiato e lavorato a mano. Montatura e dettagli in metallo cromato. Paralumi in vetro trasparente con parte centrale sabbiata. Pendenti con ottagononi e gocce in cristallo molato.



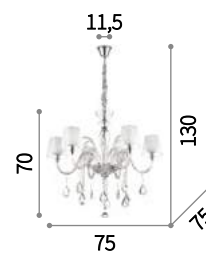

 IP20  
 E14 max 8 x 40W  
 112404 SP8

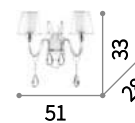

 IP20  
 E14 max 6 x 40W  
 112398 SP6





 IP20  
 E14 max 2 x 40W  
 112435 AP2

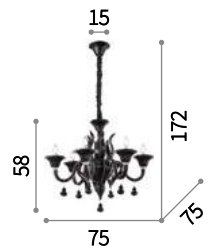

# Radetzky

Lampadario in vetro soffiato e lavorato a mano. Dettagli in metallo cromato. Copricatena in velluto.



⊕ ⊖ IP20

E14 max 6 x 40W

141084 SP6





197791

## Renoir

Lampadario in vetro soffiato con dettagli in metallo cromato. Pendagli in cristallo molato. Copricatena in velluto.



045672

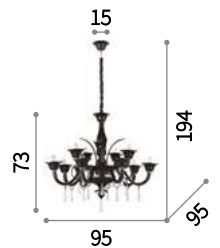

⊕ ⊖ IP20

E14 max 12 x 40W

197791 SP12 Bianco  
045672 SP12 Nero



## Ca' Foscari

Lampadario in vetro trasparente soffiato e lavorato a mano, decorato esternamente con foglia d'oro in fornace. Coppa interna in metallo ottonato.

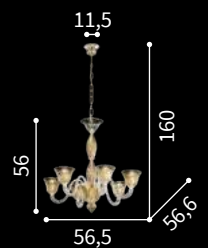

⊕ ⊖ IP20

E14 max 6 x 40W

005843 SP6



# Ca' D'oro

Lampadario in vetro trasparente soffiato e lavorato a mano, rifinito con ambra in pasta di vetro. Coppa interna in metallo ottonato.

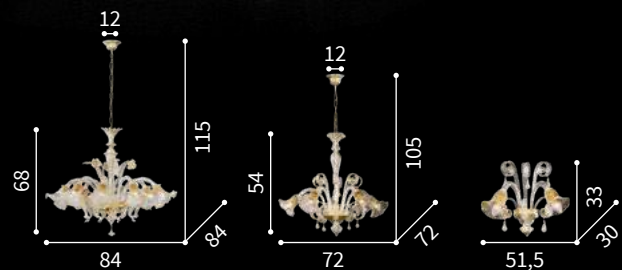

⊕ ⊖ IP20

E14 max 8 x 40W

**020976** SP8

⊕ ⊖ IP20

E14 max 5 x 40W

**020969** SP5

⊕ ⊖ IP20

E14 max 2 x 40W

**020983** AP2





# Rialto

Lampadario in vetro trasparente soffiato e lavorato a mano, rifinito con ambra in pasta di vetro. La coppa interna è in metallo ottonato.

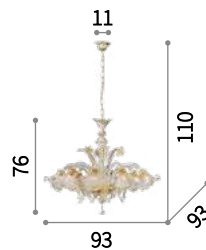

⊕ ⊖ IP20

E14 max 8 x 40W  
004099 SP8

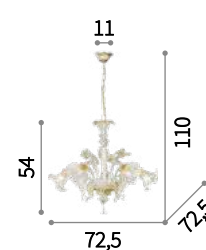

⊕ ⊖ IP20

E14 max 5 x 40W  
009704 SP5

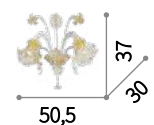

⊕ ⊖ IP20



E14 max 2 x 40W  
007953 AP2



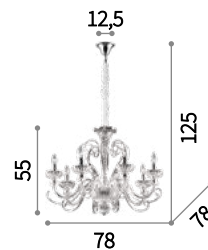

# Alexander

Lampadario in vetro trasparente soffiato e lavorato a mano. Montatura e dettagli in metallo rifinito in cromo. Copricatena in velluto.



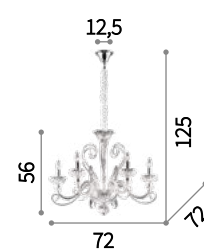

 IP20  
 E14 max 8 x 40W  
 090269 SP8

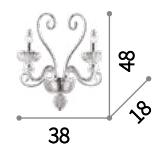

 IP20  
 E14 max 6 x 40W  
 090252 SP6





 IP20  
 E14 max 2 x 40W  
 090276 AP2



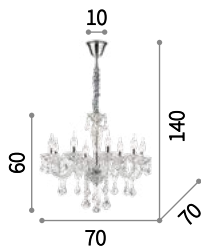

# Tiepolo

Lampadario in vetro soffiato lavorato a mano con dettagli in metallo cromato. Pendagli con ottagoni e gocce in cristallo molato. Copricatena in velluto.



⊕ ⊖ IP20

E14 max 8 x 40W  
034720 SP8



⊕ ⊖ IP20

E14 max 5 x 40W  
034713 SP5

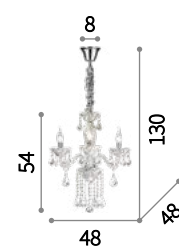

⊕ ⊖ IP20

E14 max 3 x 40W  
034706 SP3

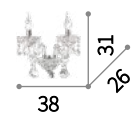

⊕ ⊖ IP20

E14 max 2 x 40W  
034737 AP2





# Amadeus

Montatura in metallo cromato. Elementi decorativi in vetro soffiato e cristallo molato. Copricatena in velluto.

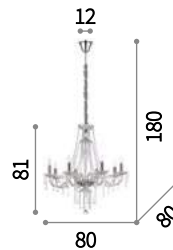

⊕ ⊖ IP20

E14 max 8 x 40W  
168777 SP8

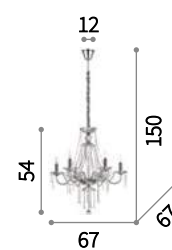

⊕ ⊖ IP20

E14 max 6 x 40W  
168753 SP6

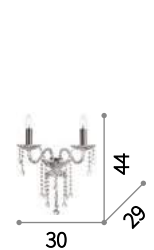

⊕ ⊖ IP20



E14 max 2 x 40W  
168746 AP2



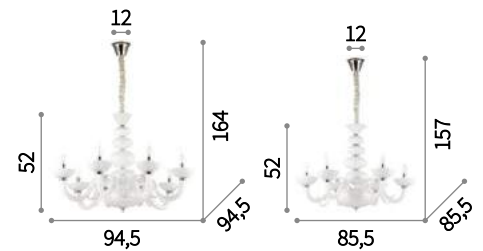

# Praga

Lampadario in vetro bianco soffiato e lavorato a mano. Elementi decorativi in vetro trasparente. Dettagli in metallo cromato. Copricatena in velluto.



 IP20  
 E14 max 8 x 40W  
 132129 SP8



 IP20  
 E14 max 6 x 40W  
 132112 SP6





# Windsor

Lampadario in vetro bianco soffiato e lavorato a mano con copri portalampade e dettagli in metallo cromato. Copricatena in velluto.



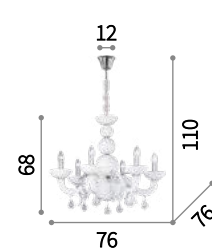

 IP20  
 E14 max 8 x 40W  
 022772 SP8

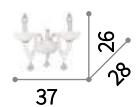

 IP20  
 E14 max 6 x 40W  
 022765 SP6





 IP20  
 E14 max 2 x 40W  
 026299 AP2



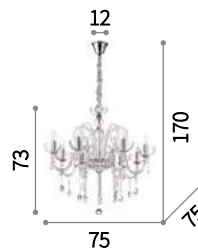

# Canaletto

Lampadario in vetro trasparente soffiato e lavorato a mano. Montatura in metallo cromato o dorato. Disponibile con bracci e pastorali trasparenti o ambra. Pendagli in cristallo molato. Copricatena in velluto.



⊕ ⊖ IP20

E14 max 8 x 40W

027630 SP8 Trasparente

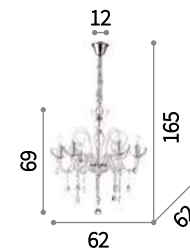

⊕ ⊖ IP20

E14 max 6 x 40W

114521 SP6 Ambra  
027623 SP6 Trasparente

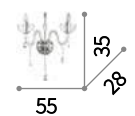

⊕ ⊖ IP20

E14 max 2 x 40W

027616 AP2 Trasparente





# Palmares

Diffusore ed elementi decorativi in vetro trasparente modellato a mano e rifinito con graniglia. Copricatena in velluto.

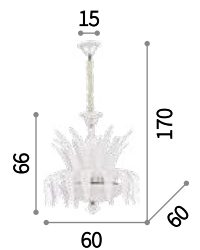

⊕ ⊖ IP20

E14 max 8 x 40W

116884 SP8



167398

# Napoleon

Montatura in metallo cromato o dorato.  
Elementi decorativi in vetro soffiato e  
cristallo molato. Copricatena in velluto.

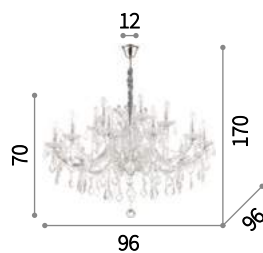

E14 max 18 x 40W  
167268 SP18 Cromo  
167411 SP18 Oro

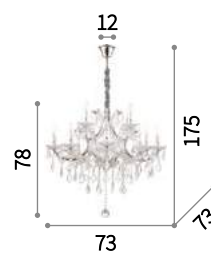

E14 max 12 x 40W  
167251 SP12 Cromo  
167404 SP12 Oro

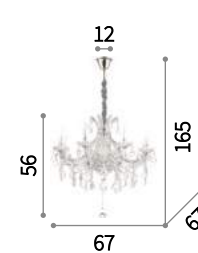

E14 max 8 x 40W  
167244 SP8 Cromo  
167398 SP8 Oro

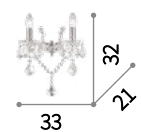

E14 max 2 x 40W  
035642 AP2 Cromo  
035659 AP2 Oro





167268



075181

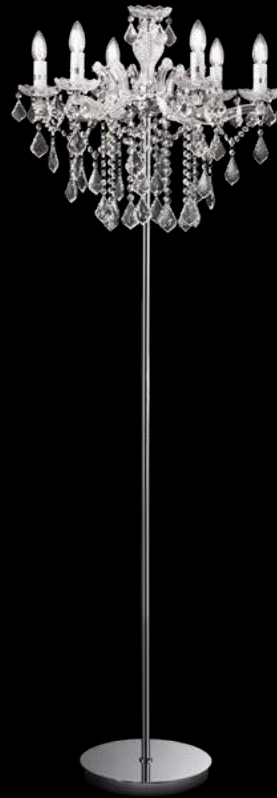

# Florian

Montatura in metallo con elementi decorativi in vetro. Pendagli con ottagoni e gocce finali in cristallo molato. Disponibile nelle versioni con vetro trasparente e metallo dorato o cromato.

**ON** Lampada con interruttore  
**OFF** integrato nel modello PT6.

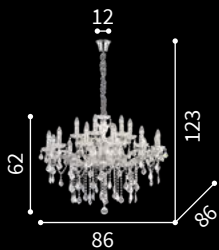

⊕ ⊖ IP20

E14 max 18 x 40W

**075150** SP18 Cromo  
**075181** SP18 Oro

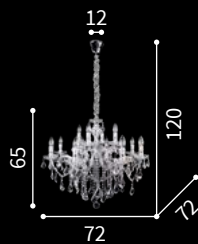

⊕ ⊖ IP20

E14 max 12 x 40W

**035604** SP12 Cromo  
**035611** SP12 Oro

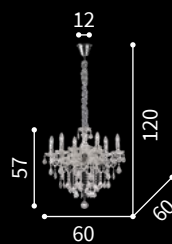

⊕ ⊖ IP20

E14 max 6 x 40W

**035628** SP6 Cromo  
**035635** SP6 Oro

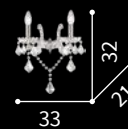

⊕ ⊖ IP20

E14 max 2 x 40W

**035642** AP2 Cromo  
**035659** AP2 Oro

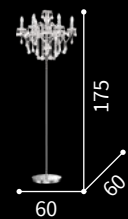

⊕ ⊖ IP20

E14 max 6 x 40W

**179902** PT6 Cromo





035604







# Pearl

Rosone e montatura in metallo cromato.  
Elementi decorativi con catene di ottoni  
in cristallo molato.

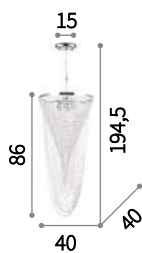

⊕ ⊖ IP20

E14 max 6 x 40W  
211558 SP6

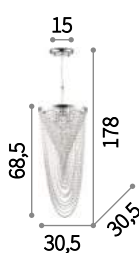

⊕ ⊖ IP20

E14 max 4 x 40W  
211541 SP4

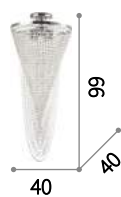

⊕ ⊖ IP20

E14 max 6 x 40W  
211572 PL6

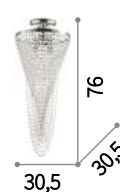

⊕ ⊖ IP20

E14 max 4 x 40W  
211565 PL4



⊕ ⊖ IP20

E14 max 2 x 40W  
211596 AP2









201016

# Dubai

Montatura in metallo. Elementi decorativi con perle, ottagoni e prismi in cristallo molato trasparente.

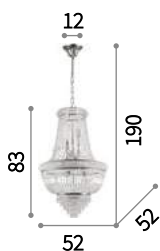

IP20

E14 max 10 x 40W

215969 SP10 Cromo  
207216 SP10 Ottone

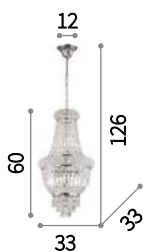

IP20

E14 max 5 x 40W

207193 SP5 Cromo  
200965 SP5 Ottone

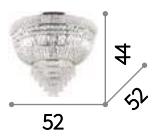

IP20

E14 max 6 x 40W

207186 PL6 Cromo  
201016 PL6 Ottone

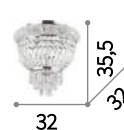

IP20

E14 max 3 x 40W

207162 PL3 Cromo  
200996 PL3 Ottone



IP20

E14 max 2 x 40W

207155 AP2 Cromo  
201023 AP2 Ottone



215969





103792

# Caesar

Montatura in metallo con finitura in oro o cromo. Elementi decorativi in cristallo molato ottagonali con finili a puntale.



Lampadine ALO G9 28W 2700 K incluse.

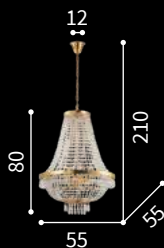

G9 max 12 x 40W

**114279** SP12 Cromo  
**114743** SP12 Oro



G9 max 9 x 40W

**041827** SP9 Cromo  
**114736** SP9 Oro



G9 max 6 x 40W

**033532** SP6 Cromo  
**114729** SP6 Oro

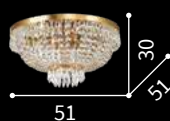

G9 max 6 x 40W

**093475** PL6 Cromo  
**114682** PL6 Oro

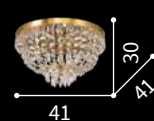

G9 max 5 x 40W

**103792** PL5 Cromo  
**114675** PL5 Oro

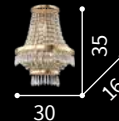

G9 max 3 x 40W

**137698** AP3 Cromo  
**137704** AP3 Oro





114743







113197



# Augustus

Montatura in metallo cromato o dorato.  
Elementi decorativi con perle di cristallo  
molato.



Lampadine ALO G9 28W 2700 K  
includere.



G9 max 12 x 40W  
112800 SP12 Cromo  
113197 SP12 Oro

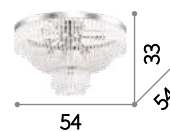

G9 max 10 x 40W  
112848 PL10 Cromo

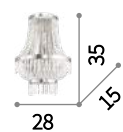

G9 max 3 x 40W  
112817 AP3 Cromo



112800







# Luxor

Montatura in metallo cromato. Diffusore con elementi decorativi ottagonali e rettangolari in cristallo molato. Copricatena in velluto.

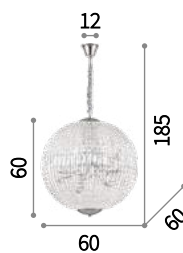



Lampadine ALO G9 28W 2700 K incluse.





  IP20  INCLUSA  
G9 max 12 x 40W  
116235 SP12

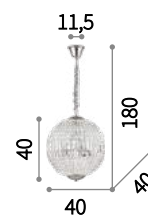

  IP20  INCLUSA  
G9 max 8 x 40W  
116228 SP8



  IP20  INCLUSA  
G9 max 6 x 40W  
092911 SP6







100791



# Pashà

Montatura in metallo. Diffusore composto da filari di perle in cristallo molato e fondo chiuso da vetro circolare sabbiato. Cavi in acciaio a lunghezza regolabile con dispositivi fermacavo automatici.



Lampadine ALO G9 28W 2700 K incluse nel modello AP3.

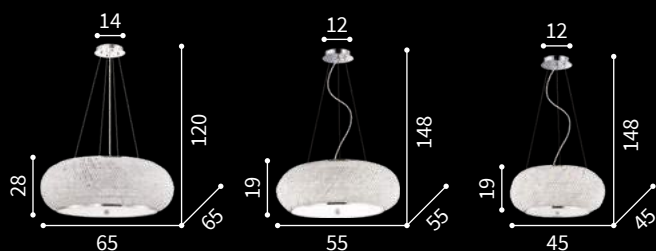

IP20

E14 max 14 x 40W

**164977** SP14 Cromo  
**164984** SP14 Oro

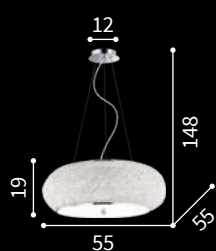

IP20

E14 max 10 x 40W

**082196** SP10 Cromo  
**082257** SP10 Oro

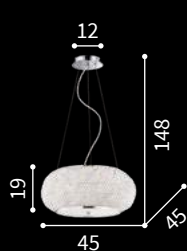

IP20

E14 max 6 x 40W

**082158** SP6 Cromo  
**082172** SP6 Oro



IP20

E14 max 14 x 40W

**164991** PL14 Cromo  
**165004** PL14 Oro



IP20

E14 max 10 x 40W

**100746** PL10 Cromo  
**100791** PL10 Oro



IP20

E14 max 6 x 40W

**100784** PL6 Cromo  
**100807** PL6 Oro



082196

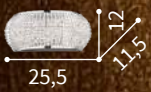

IP20

G9 max 3 x 40W

082264 AP3 Cromo  
082288 AP3 Oro





# Evasione

Pendagli in cristallo molato. Sospensioni con cavo in acciaio a lunghezza regolabile da dispositivo fermacavo automatico.



Lampadine ALO G9 28W 2700 K incluse.



G9 max 10 x 40W  
044767 SP10



G9 max 8 x 40W  
044774 SP8

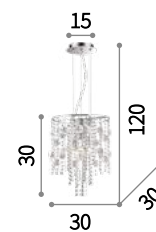

G9 max 4 x 40W  
062211 SP4

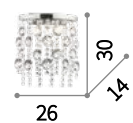

G9 max 3 x 40W  
044750 AP3





# Audi-77

Pendagli ottagonali e tondi in cristallo molato. Sospensioni con cavi a lunghezza regolabile da dispositivi automatici.





Lampadine ALO G9 28W 2700 K incluse.

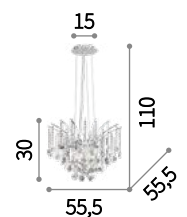

 IP20
 
  
 G9 max 8 x 40W  
 020556 SP8



 IP20
 
  
 G9 max 6 x 40W  
 019499 SP6





# Romantik

Montatura in metallo rifinito argento antico. Bracci in vetro soffiato. Elementi decorativi in cristallo molato. Copricatena in velluto.



⊕ ⊖ IP20  
E14 max 6 x 40W  
174945 SP6



⊕ ⊖ IP20  
E14 max 2 x 40W  
174914 AP2





# Impero

Corpo luce in fusione di metallo con finitura argento antico. Elementi decorativi in cristallo molato. Copricatena in velluto.

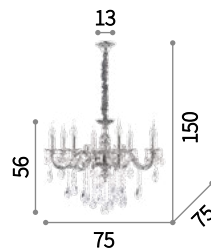

⊕ ⊖ IP20

E14 max 8 x 40W  
014395 SP8

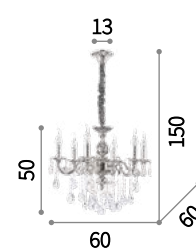

⊕ ⊖ IP20

E14 max 6 x 40W  
002408 SP6

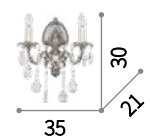

⊕ ⊖ IP20

E14 max 2 x 40W  
030210 AP2



164960



# Gioconda

Corpo luce in fusione di metallo con finitura oro o argento antico. Pendagli ottagonali e tondi in cristallo molato. Copricatena in velluto.

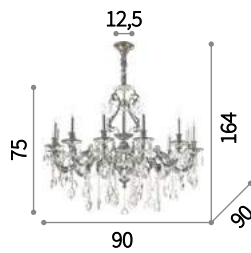

⊕ ⊖ IP20

E14 max 12 x 40W

164953 SP12 Argento  
164960 SP12 Oro

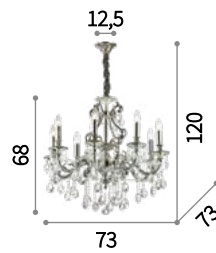

⊕ ⊖ IP20

E14 max 8 x 40W

044934 SP8 Argento  
060514 SP8 Oro

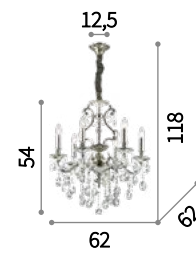

⊕ ⊖ IP20

E14 max 6 x 40W

044927 SP6 Argento  
060507 SP6 Oro

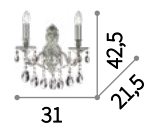

⊕ ⊖ IP20

E14 max 2 x 40W

044910 AP2 Argento  
060491 AP2 Oro





044934







# Liberty

Montatura in metallo verniciato color ruggine. Elementi decorativi in cristallo molato. Copricatena in velluto.

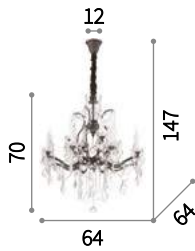

⊕ ⊖ IP20

E14 max 12 x 40W  
166551 SP12

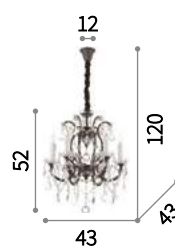

⊕ ⊖ IP20

E14 max 6 x 40W  
073729 SP6

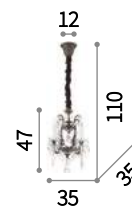

⊕ ⊖ IP20

E14 max 4 x 40W  
166544 SP4

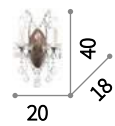

⊕ ⊖ IP20

E14 max 2 x 40W  
073651 AP2





# Vanity

Montatura in metallo dorato con dettagli nero opaco. Elementi decorativi in cristallo molato. Copricatena in velluto.

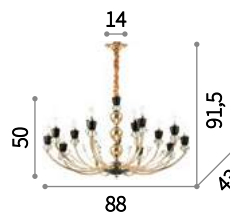

⊕ ⊖ IP20

E14 max 15 x 40W  
206639 SP15

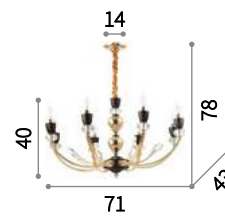

⊕ ⊖ IP20

E14 max 8 x 40W  
206622 SP8

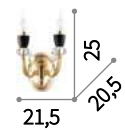

⊕ ⊖ IP20

E14 max 2 x 40W  
206646 AP2







# Elisir

Montatura in metallo. Elementi decorativi a prisma in cristallo molato trasparente nella versione cromo, ambra in quella ottone.

**LED** Lampadine LED G9 3,2W 3000 K incluse. Cod. 209043

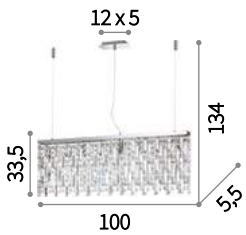

IP20  
G9 max 8 x 40W  
200002 SP8 Cromo  
200071 SP8 Ottone

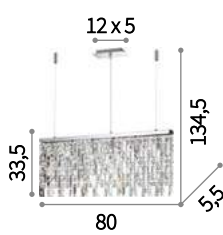

IP20  
G9 max 6 x 40W  
199993 SP6 Cromo  
200064 SP6 Ottone

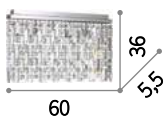

IP20  
G9 max 6 x 40W  
200026 PL6 Cromo  
200095 PL6 Ottone

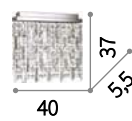

IP20  
G9 max 4 x 40W  
200019 PL4 Cromo  
200088 PL4 Ottone

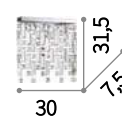

IP20  
G9 max 3 x 40W  
199986 AP3 Cromo  
200057 AP3 Ottone

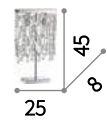

IP20  
G9 max 2 x 40W  
200033 TL2 Cromo  
200101 TL2 Ottone

200071







166360

# Martinez

Montatura in metallo. Elementi decorativi con catene di ottagoni e barre in cristallo molato trasparente.



213545

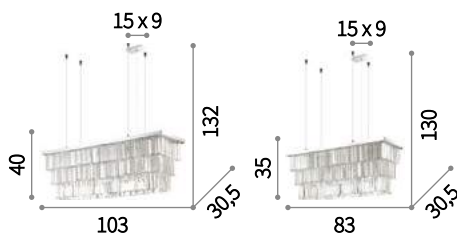

IP20

E14 max 8 x 40W

166360 SP8 Cromo  
213583 SP8 Oro

IP20

E14 max 6 x 40W

166322 SP6 Cromo



IP20

E14 max 8 x 40W

166285 PL8 Cromo  
213569 PL8 Oro



IP20

E14 max 6 x 40W

166261 PL6 Cromo

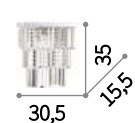

IP20

E14 max 3 x 40W

166254 AP3 Cromo  
213545 AP3 Oro



166247

# Carlton

Montatura in metallo. Elementi decorativi con catene di ottoni e barre in cristallo molato trasparente.



213507

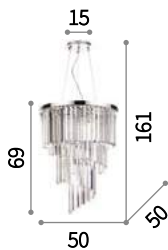

IP20

E14 max 12 x 40W

166247 SP12 Cromo  
213521 SP12 Oro

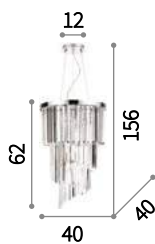

IP20

E14 max 8 x 40W

117737 SP8 Cromo

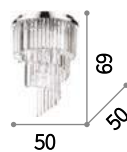

IP20

E14 max 12 x 40W

168937 PL12 Cromo  
213507 PL12 Oro

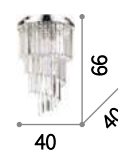

IP20

E14 max 8 x 40W

168920 PL8 Cromo

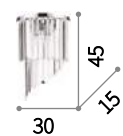

IP20

E14 max 3 x 40W

168913 AP3 Cromo  
213491 AP3 Oro

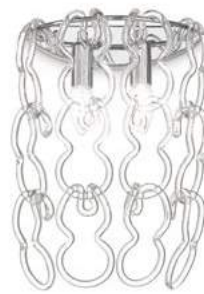

# Alba

Montatura in cromo. Vetri in canna di pirex sagomati a mano e componibili a piacere. Sospensioni con cavi in acciaio a lunghezza regolabile da dispositivi automatici.



⊕ ⊖ IP20

E14 max 7 x 40W  
007151 SP7 Oval



⊕ ⊖ IP20

E14 max 6 x 40W +  
E27 max 1 x 60W  
020365 SP7 Round



⊕ ⊖ IP20

E14 max 3 / 6 x 40W +  
E27 max 1 x 60W  
026008 PL4  
025490 PL7

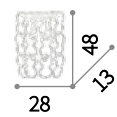

⊕ ⊖ IP20

E14 max 2 x 40W  
020372 AP2









# Majestic

Montatura circolare in metallo cromato.  
Elementi decorativi con canne di vetro  
modellate artigianalmente e fissate con  
clip a cavi metallici.





Lampadine ALO G9 28W 2700 K  
includere.

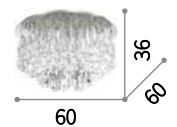

 IP20
 
  
 G9 max 10 x 40W  
 087269 SP10



 IP20
 
  
 G9 max 10 x 40W  
 113562 PL10





# Elegant

Montatura in cromo. Canne in vetro trasparente con sezione a stella.  
Plafoniere con sfere centrali di cristallo molato.



Lampadine ALO G9 28W 2700 K  
includi nei modelli: PL12 e PL8.

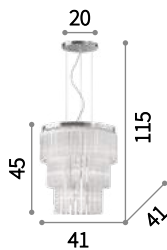

⊕ ⊖ IP20

E14 max 12 x 40W  
026695 SP12

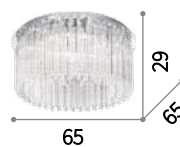

⊕ ⊖ IP20

G9 max 12 x 40W  
019468 PL12

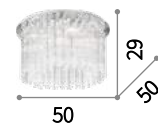

⊕ ⊖ IP20

G9 max 8 x 40W  
019451 PL8

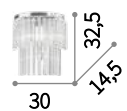

⊕ ⊖ IP20

E14 max 3 x 40W  
027975 AP3



103327



122601



068275



# Opera

Montatura in cromo. Paralume in lamina di PVC con riflessi metallizzati e rivestita da fili. Pendagli in cristallo molato. Sospensioni con cavi in acciaio a lunghezza regolabile.

**LED** Sorgente luminosa LED 3000 K nel modello AP3, 15.000 h di durata.

**ON OFF** Lampada con interruttore integrato nei modelli: AP3, TL1 e PT1.

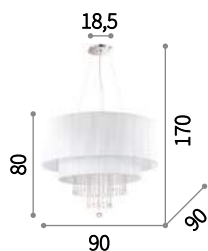

⊕ ⊖ IP20

E27 max 10 x 60W  
165011 SP10 Bianco



⊕ ⊖ IP20

E27 max 6 x 60W  
122601 SP6 Argento  
068299 SP6 Bianco  
103327 SP6 Nero



⊕ ⊖ IP20

E27 max 4 x 60W  
182179 SP4 Bianco

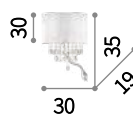

⊕ ⊖ IP20

E14 max 2 x 40W +  
LED 1W / 45 Lm  
122588 AP3 Argento  
068268 AP3 Bianco



⊕ ⊖ IP20

E27 max 1 x 60W  
068305 TL1 Bianco

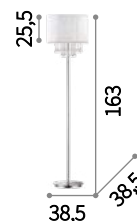

⊕ ⊖ IP20

E27 max 1 x 60W  
068275 PT1 Bianco







# Paris

Montatura in nickel satinato. Bobeches in cristallo molato. Paralume in lamina di PVC rivestita da fili argentati. Sospensione con cavi in acciaio a lunghezza regolabile.



 Lampada con interruttore integrato nei modelli: TL1 Big, TL1 Small e PT1.

 Lampada con dimmer nei modelli: TL1 Big, TL1 Small e PT1.



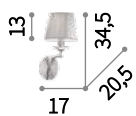

  IP20  
E14 max 3 x 40W  
018010 SP3





  IP20  
E14 max 1 x 40W  
018027 AP1



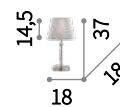

  IP20   
E27 max 1 x 60W  
014975 TL1 Big

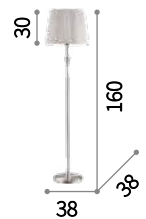

  IP20   
E14 max 1 x 40W  
015965 TL1 Small



  IP20   
E27 max 1 x 60W  
014968 PT1







208152



# Swan

Montatura in cromo. Corpo luce in vetro soffiato e lavorato a mano. Elementi decorativi in cristallo molato. Paralume in tessuto d'organza plissettato. Copricatena in velluto.



⊕ ⊖ IP20

E14 max 6 x 40W

208152 SP6 Argento  
035826 SP6 Bianco



⊕ ⊖ IP20

E14 max 3 x 40W

208497 SP3 Argento  
035840 SP3 Bianco

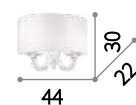

⊕ ⊖ IP20

E14 max 2 x 40W

208503 AP2 Argento  
035864 AP2 Bianco



035826





# Queen

Montatura in metallo dorato con elementi decorativi e base in cristallo molato. Paralume in lamina di PVC, rivestita in tessuto con decorazione trapuntata e brillantini dorati.

**ON** Lampada con interruttore integrato  
**OFF** nei modelli: TL1 e PT1.



⊕ ⊖ IP20

E14 max 3 x 40W

079400 SP3

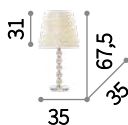

⊕ ⊖ IP20

E27 max 1 x 60W

077758 TL1 Big



⊕ ⊖ IP20

E27 max 1 x 60W

077741 TL1 Medium

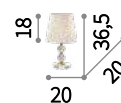

⊕ ⊖ IP20

E27 max 1 x 60W

077734 TL1 Small



⊕ ⊖ IP20

E27 max 1 x 60W

077765 PT1



# Le Roy

Montatura e base in metallo cromato con elementi decorativi in cristallo molato. Paralume in lamina di PVC, rivestita in tessuto con decorazione trapuntata e brillantini argentati.

**ON** Lampada con interruttore integrato  
**OFF** nei modelli: TL1 e PT1.



⊕ ⊖ IP20

E14 max 3 x 40W

079387 SP3

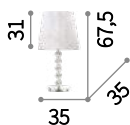

⊕ ⊖ IP20

E27 max 1 x 60W

073408 TL1 Big

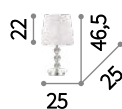

⊕ ⊖ IP20

E27 max 1 x 60W

073422 TL1 Medium

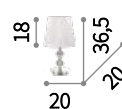

⊕ ⊖ IP20

E27 max 1 x 60W

073439 TL1 Small



⊕ ⊖ IP20

E27 max 1 x 60W

073392 PT1







035581



## Blanche

Montatura in metallo rifinito con smalto satinato bianco o nero. Paralumi in lamina di PVC rivestita di tessuto bianco o nero. Copricatena in velluto.

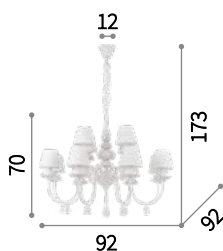

E14 max 12 x 40W  
114224 SP12 Bianco

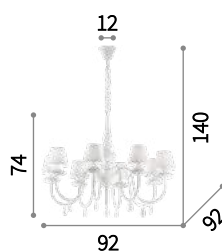

E14 max 8 x 40W  
035574 SP8 Bianco  
111896 SP8 Nero

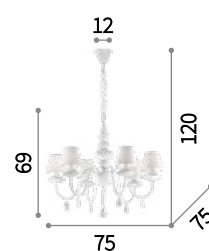

E14 max 6 x 40W  
035581 SP6 Bianco  
111872 SP6 Nero

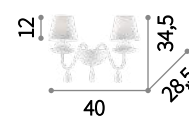

E14 max 2 x 40W  
035598 AP2 Bianco  
111889 AP2 Nero



111896





059235

# Pegaso

Montatura in metallo. Corpo centrale, bobeches e pendagli in cristallo molato. Paralumi in organza. Copricatena in velluto.

 Lampada con interruttore integrato nei modelli: TL1 e PT1.

 Lampada con dimmer nel modello PT1.

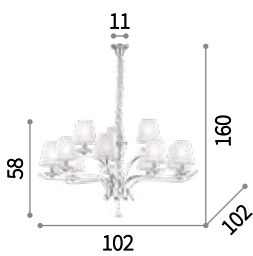

  IP20

E14 max 12 x 40W

066431 SP12 Bianco

197746 SP12 Ottone Satinato

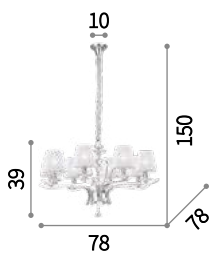

  IP20

E14 max 8 x 40W

059242 SP8 Bianco

197739 SP8 Ottone Satinato

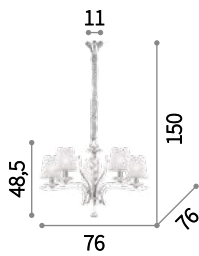

  IP20

E14 max 5 x 40W

066448 SP5 Bianco

197722 SP5 Ottone Satinato



  IP20

E14 max 3 x 40W

059235 SP3 Bianco

197715 SP3 Ottone Satinato



  IP20

E14 max 2 x 40W

059211 AP2 Bianco

197708 AP2 Ottone Satinato



  IP20

E27 max 1 x 60W

059259 TL1 Big Bianco



197746

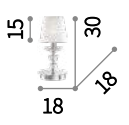

○ □ IP20  
E14 max 1 x 40W

059266 TL1 Small Bianco  
197753 TL1 Small Ottone Sat.

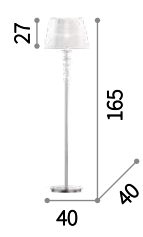

○ □ IP20  
E27 max 1 x 60W

059228 PT1 Bianco



# Violette

Montatura in metallo cromato con perle di vetro. Bobeches e pendagli in cristallo molato. Paralume in lamina di PVC, rivestita da fili in tessuto argentato.

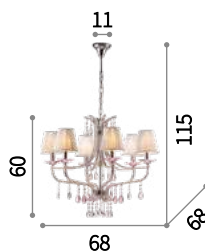

⊕ ⊖ IP20  
E14 max 6 x 40W  
015439 SP6



⊕ ⊖ IP20  
E14 max 3 x 40W  
018072 SP3

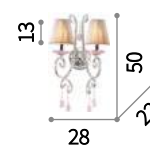

⊕ ⊖ IP20  
E14 max 2 x 40W  
015446 AP2







# Accademy

Montatura in metallo cromato. Bobeches e pendagli in cristallo molato. Paralumi in lamina di PVC rivestita da fili neri. Copricatena in velluto.

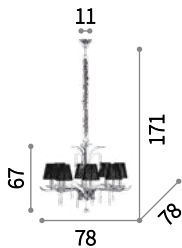

 Lampada con interruttore integrato nei modelli: TL1 e PT1.

 Lampada con dimmer nel modello PT1.



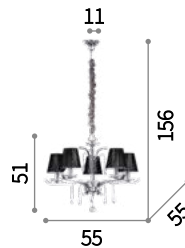

  IP20  
E14 max 8 x 40W  
020594 SP8



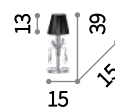

  IP20  
E14 max 5 x 40W  
020600 SP5



  IP20  
E14 max 1 x 40W  
023182 TL1



  IP20   
E27 max 1 x 60W  
026039 PT1



088105



# Pantheon

Montatura in metallo. Elemento centrale con biglie in vetro. Pendagli e bobecche in cristallo molato. Paralume di tessuto con decorazione in rilievo e brillantini. Copricatena in velluto.

**ON** Lampada con interruttore integrato  
**OFF** nel modello TL1.

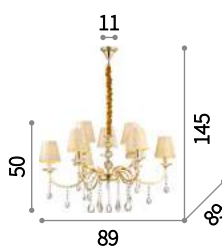

⊕ ⊖ IP20

E14 max 9 x 40W

088105 SP9 Oro



⊕ ⊖ IP20

E14 max 6 x 40W

088051 SP6 Argento  
088068 SP6 Oro

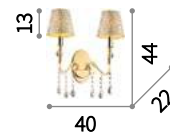

⊕ ⊖ IP20

E14 max 2 x 40W

088136 AP2 Argento  
088143 AP2 Oro

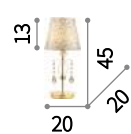

⊕ ⊖ IP20

E14 max 1 x 40W

088167 TL1 Oro



088051







# Event

Montatura in metallo cromato. Elemento centrale e bobecche in vetro soffiato trasparente. Paralumi in vetro fumè con parte interna trasparente sabbiata. Copricatena in velluto.

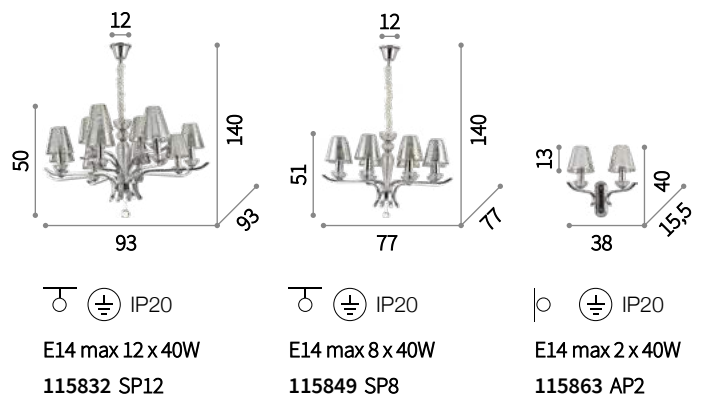







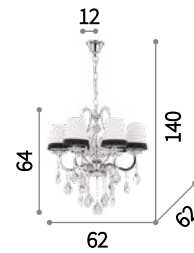

# Domus

Montatura in metallo cromato. Paralumi in lamina di PVC rivestita di tessuto bicolore. Bobeches e pendagli in cristallo molato.

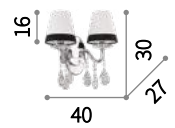

 IP20  
 E14 max 6 x 40W  
 093147 SP6



 IP20  
 E14 max 2 x 40W  
 093321 AP2





# Duca

Montatura in metallo cromato con mazza centrale e coppa ottenute da stampi.  
Diffusori in vetro pyrex cromato.



Lampadine ALO G9 28W 2700 K include.

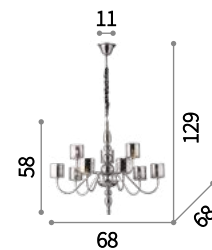

IP20 
  
G9 max 9 x 40W
   
031712 SP9

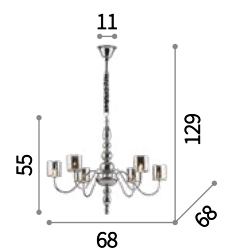

IP20 
  
G9 max 6 x 40W
   
004556 SP6



# Senix

Montatura in metallo cromato. Paralumi in lamina di PVC rivestita di tessuto con fantasia floreale in rilievo. Bobeches e pendagli in cristallo molato. Copricatena in velluto.

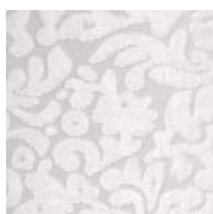

 Lampada con interruttore integrato nel modello PT1.

 Lampada con dimmer nel modello PT1.

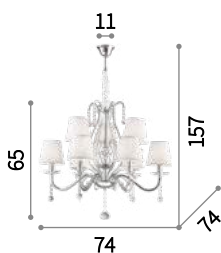
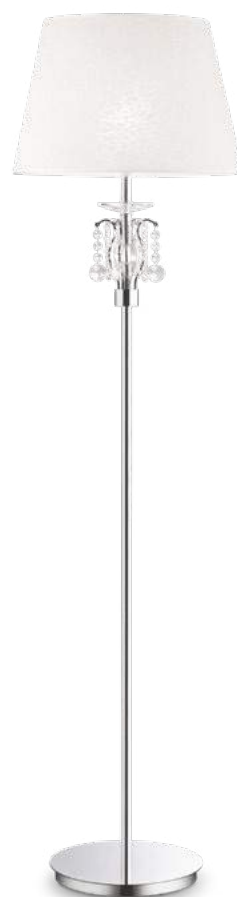

E14 max 9 x 40W

032610 SP9

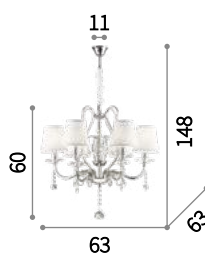

E14 max 6 x 40W

032597 SP6

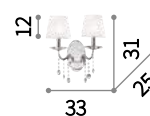

E14 max 2 x 40W

032573 AP2

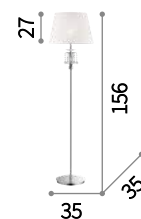

E27 max 1 x 60W

032672 PT1







# Amaca

Rosone in metallo verniciato bianco opaco. Cavo avvolto da corde. Paralume con tessuto naturale intercambiabile e lavabile.

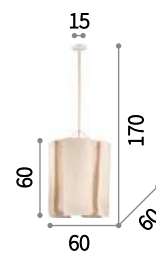

⊕ ⊖ IP20

E27 max 1 x 60W  
207650 SP1 D60

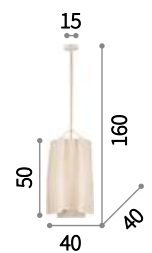

⊕ ⊖ IP20

E27 max 1 x 60W  
207636 SP1 D40





# Kronplatz



Montatura in metallo cromato. Paralume in lamina di PVC rivestita con tessuto canvas. Sospensioni con cavi in acciaio a lunghezza regolabile da dispositivi automatici.

 Lampadine ALO G9 28W 2700 K incluse nel modello TL1.

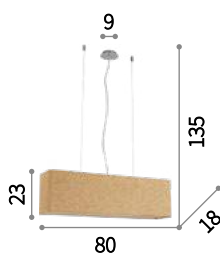

 Sorgente luminosa LED 3000 K nel modello AP2, 15.000 h di durata.

 Lampada con interruttore integrato nei modelli: AP2, TL1 e PT1.



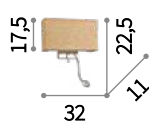

  IP20  
E14 max 4 x 40W  
110899 SP4





  IP20  
E27 max 1 x 60W + LED 1W / 45 Lm  
103204 AP2



  IP20   
G9 max 1 x 40W  
110875 TL1



  IP20  
E27 max 1 x 60W  
110882 PT1









# Peter

Montatura in resina lavorata artigianalmente come fedele riproduzione del legno intagliato. Paralume in lamina di PVC rivestito in tessuto canvas. Sospensioni con cavi in acciaio a lunghezza regolabile da dispositivi automatici.

**ON** Lampada con interruttore integrato  
**OFF** nel modello TL1.

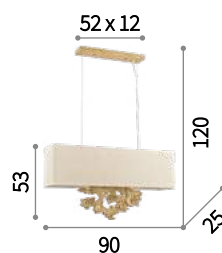

⊕ ⊖ IP20  
E14 max 5 x 40W  
104294 SP5

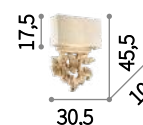

⊕ ⊖ IP20  
E14 max 2 x 40W  
075211 AP2

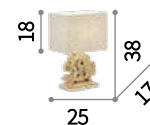

⊕ ⊖ IP20  
E14 max 1 x 40W  
094021 TL1





# Provence

Corpo luce in legno tornito e bracci in metallo. Finitura con vernice opaca. Paralumi in lamina di PVC rivestita in tessuto a trama grossa.

**ON**  
**OFF** Lampada con interruttore integrato nei modelli: TL1 e PT1.

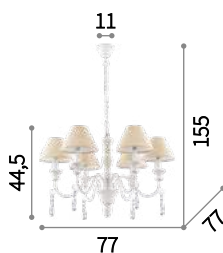

⊕ ⊖ IP20  
E14 max 6 x 40W  
003399 SP6

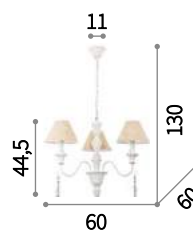

⊕ ⊖ IP20  
E14 max 3 x 40W  
025032 SP3

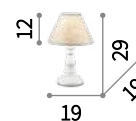

⊕ ⊖ IP20  
E14 max 1 x 40W  
003283 TL1



⊕ ⊖ IP20  
E27 max 1 x 60W  
022987 PT1







# Haunt

Rosone in metallo verniciato bianco opaco. Cavo in tessuto. Diffusore con cesto in vimini al naturale o verniciato in bianco.

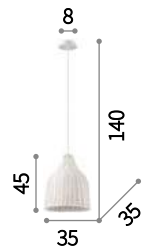

⊕ ⊖ IP20

E27 max 1x60W

159256 SP1 Bianco  
159812 SP1 Legno





162751

# Monet

Montatura in metallo con fasce circolari decorate a sbalzo. Catene con perle in legno naturale. Finitura con vernice opaca.



162782



⊕ ⊖ IP20

E14 max 6 x 40W

162751 SP6 Bianco  
162782 SP6 Grigio

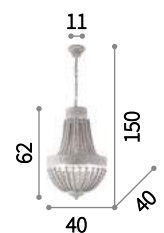

⊕ ⊖ IP20

E14 max 5 x 40W

162737 SP5 Bianco  
162744 SP5 Grigio



# Millennium

Montatura e dettagli in metallo verniciato con effetto ruggine. Elementi decorativi centrali in legno naturale antichizzato.

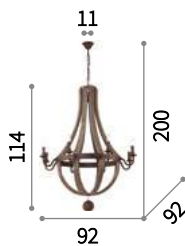

⊕ ⊖ IP20

E14 max 8 x 40W  
129709 SP8

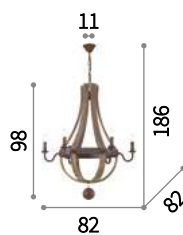

⊕ ⊖ IP20

E14 max 6 x 40W  
129693 SP6

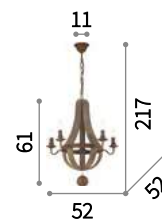

⊕ ⊖ IP20

E14 max 5 x 40W  
129921 SP5

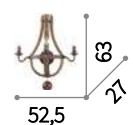

⊕ ⊖ IP20

E14 max 3 x 40W  
136875 AP3











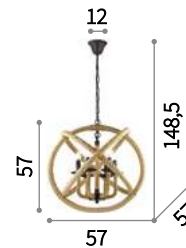

# Corda

Montatura e dettagli in metallo verniciato nero opaco con parti rivestite in corda di canapa naturale.

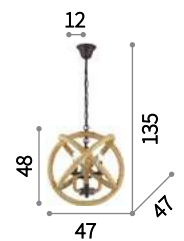

 IP20  
 E14 max 6 x 40W  
 130910 SP6







 IP20  
 E14 max 3 x 40W  
 130903 SP3



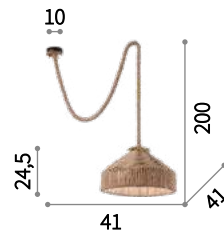

# Canapa

Montature metalliche e cavi elettrici rivestiti interamente in corda di canapa naturale.





 IP20  
 E27 max 1 x 15W  
 134833 SP1

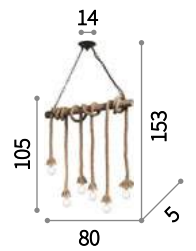

 IP20  
 E27 max 2 x 15W  
 134840 SP2







 IP20  
 E27 max 6 x 15W  
 134826 SP6



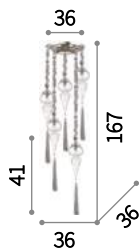

# Hammam

Montatura in metallo rifinito argento.  
 Diffusori in vetro soffiato trasparente.  
 Pendagli a nappa. Copricatena in velluto.



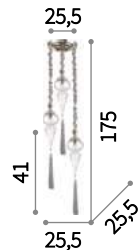

 IP20  
 E14 max 5 x 40W  
 139586 SP5



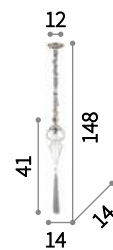

 IP20  
 E14 max 3 x 40W  
 135823 SP3



 IP20  
 E14 max 1 x 40W  
 135816 SP1



 IP20  
 E14 max 1 x 40W  
 139593 AP1









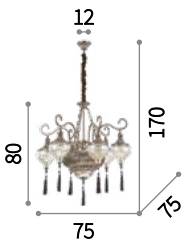

# Harem

Montatura con decori in rilievo in metallo brunito e ottagononi in cristallo molato incastonati. Diffusori in vetro soffiato trasparente leggermente ambrato con pendaglio a nappa. Copricatena in velluto.



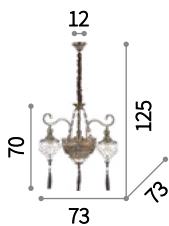

 IP20  
 E27 max 9 x 60W  
 116006 SP9





 IP20  
 E27 max 5 x 60W  
 115993 SP5







 IP20  
 E27 max 3 x 60W  
 115986 SP3





 IP20  
 E27 max 1 x 60W  
 115979 SP1

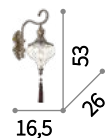



 IP20  
 E27 max 3 x 42W  
 139609 PL3



 IP20  
 E27 max 1 x 60W  
 115962 AP1







Nawa-3

Nawa-2

Nawa-1

# Nawa

Montatura e diffusore in metallo traforato con finitura effetto argento.

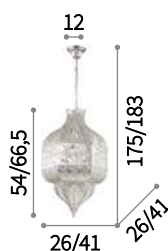

⊕ ⊖ IP20

E27 max 3 / 8 x 60W

141923 Nawa-1 SP3  
141954 Nawa-1 SP8

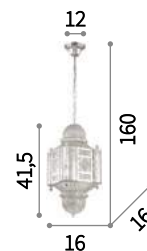

⊕ ⊖ IP20

E27 max 1 x 60W

138343 Nawa-2 SP1



⊕ ⊖ IP20

E27 max 1 x 60W

140827 Nawa-3 SP1





# Marrakech

Montatura e diffusore in metallo traforato con finitura effetto argento.

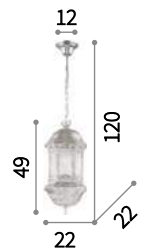

⊕ ⊖ IP20  
E27 max 2x 60W  
135175 SP2

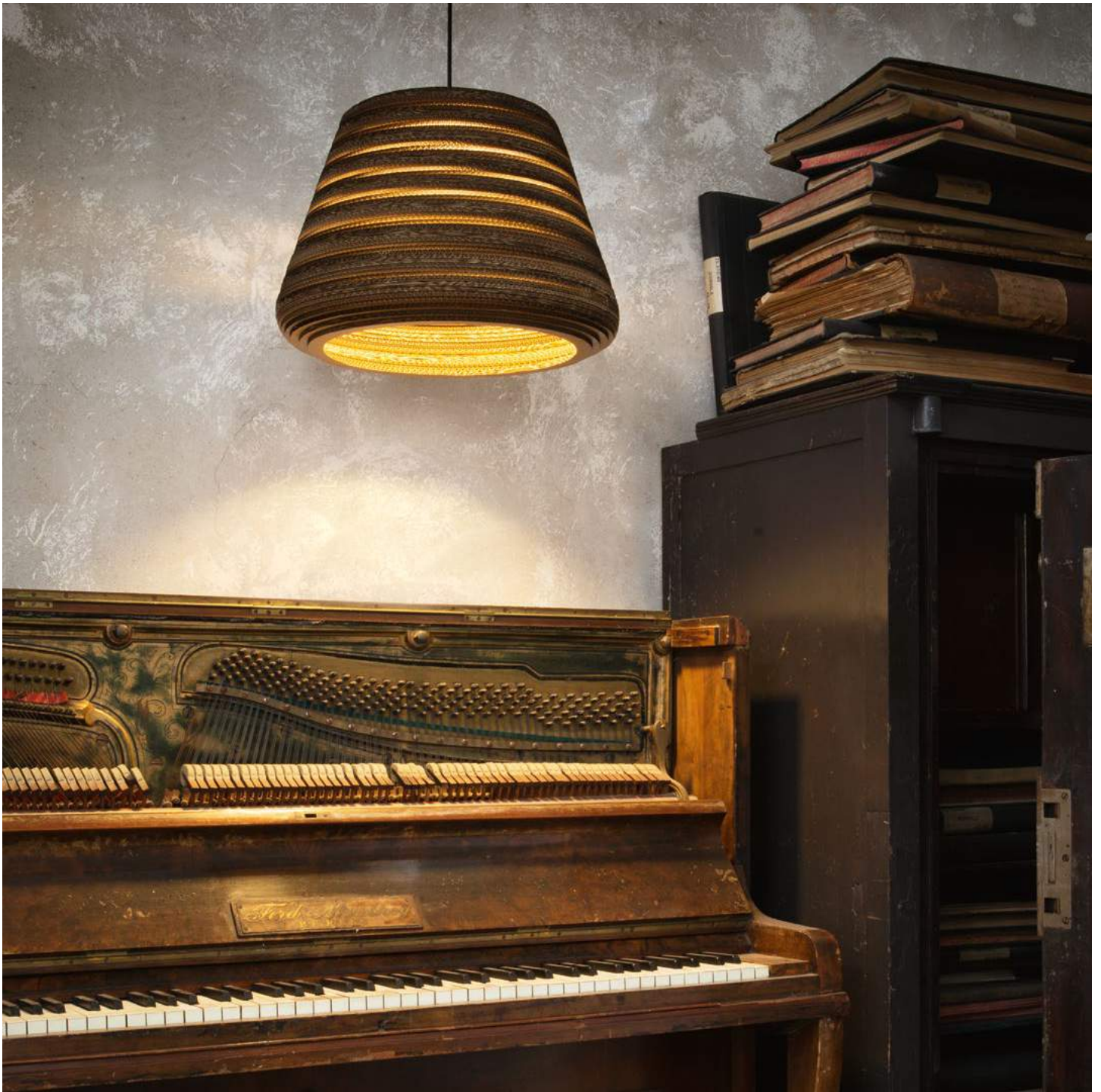

# Paper

Montatura in metallo con finitura nero opaco. Diffusore composto da strati di cartone grezzo sagomato.



⊕ ⊖ IP20

E27 max 1x60W

146294 SP1







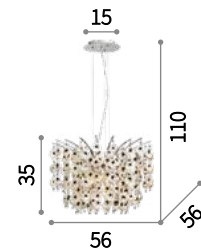

# Pavone

Montatura in metallo cromato. Elementi decorativi in madreperla e ottagoni di cristallo. Per la sospensione, cavi in acciaio a lunghezza regolabile con dispositivi fermacavo automatici.

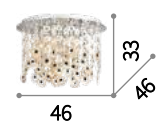

 IP20  
 E14 max 6 x 40W  
 016870 SP6





 IP20  
 E14 max 5 x 40W  
 017013 PL5



# Chalet

Montatura con struttura portante in metallo. Elementi decorativi in resina lavorata artigianalmente e dipinta a mano come fedele riproduzione di corna e legno intagliato.

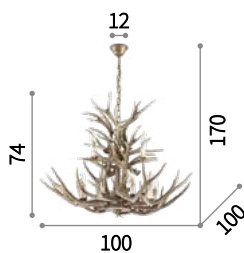
**ON** Lampada con interruttore integrato  
**OFF** nel modello TL1.



⊕ ⊖ IP20  
E14 max 12 x 40W  
113975 SP12

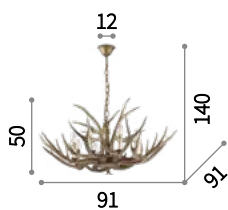

⊕ ⊖ IP20  
E14 max 8 x 40W  
115504 SP8

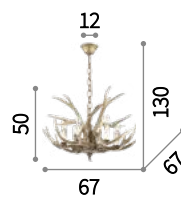

⊕ ⊖ IP20  
E14 max 6 x 40W  
115498 SP6

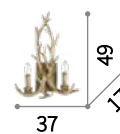

⊕ ⊖ IP20  
E14 max 2 x 40W  
115511 AP2



⊕ ⊖ IP20  
E27 max 1 x 60W  
128207 TL1









# Driftwood

Montatura in metallo. Elementi decorativi con rami di legno naturale. Diffusore in lamina di pvc rivestito con tessuto canvas.

**ON** Lampada con interruttore integrato  
**OFF** nei modelli: TL1, PT1 e PT2.

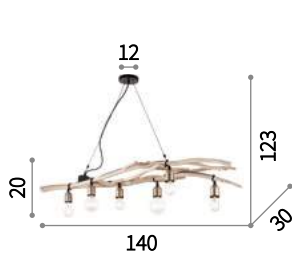

⊕ ⊞ IP20

E27 max 6 x 60W

180922 SP6

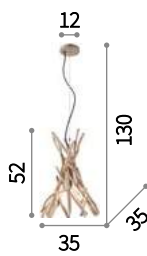

⊕ ⊞ IP20

E27 max 1 x 60W

129600 SP1



⊕ ⊞ IP20

E27 max 1 x 60W

129570 TL1



⊕ ⊞ IP20

E27 max 1 x 60W

148939 PT1



⊕ ⊞ IP20

E27 max 2 x 60W

180946 PT2







# Edith

Rosone e bracci in metallo con finitura rustica. Corpo luce ed elementi decorativi in legno naturale intagliato e dipinto a mano.

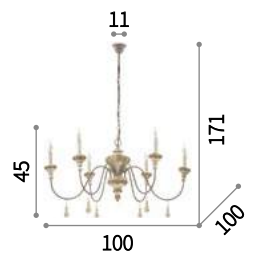

⊕ ⊞ IP20

E14 max 6 x 40W

179254 SP6







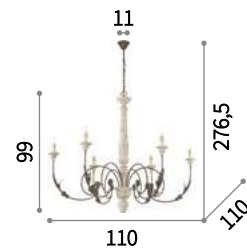

# Volterra

Rosone e bracci in metallo con finitura rustica. Corpo luce ed elementi decorativi in legno naturale intagliato e dipinto a mano.

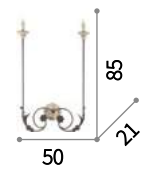

 IP20  
 E14 max 6 x 40W  
 166483 SP6



 IP20  
 E14 max 2 x 40W  
 166421 AP2



075334

# Giglio

Montatura con struttura portante in metallo. Corpo luce in resina modellata con tecniche artigianali che riproducono fedelmente il legno intagliato. Decorato e antichizzato a mano con foglia d'oro o con vernice argentata o bianca.



075280

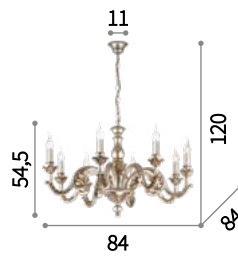

⊕ ⊖ IP20

E14 max 8 x 40W

075334 SP8 Argento  
075341 SP8 Oro

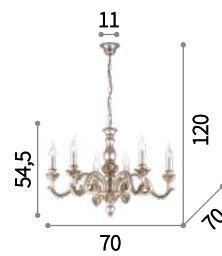

⊕ ⊖ IP20

E14 max 6 x 40W

075310 SP6 Argento  
075327 SP6 Oro

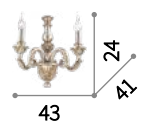

⊕ ⊖ IP20

E14 max 2 x 40W

075242 AP2 Argento  
075280 AP2 Oro









# Firenze

Corpo luce in resina. Bracci e foglie in metallo modellato artigianalmente. Decorato a mano con foglia d'oro e antichizzato.

**ON** Lampada con interruttore integrato  
**OFF** nei modelli: TL1 e PT1.



⊕ ⊖ IP20  
E14 max 8 x 40W  
012872 SP8

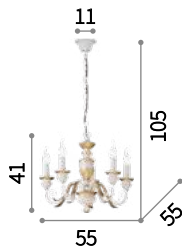

⊕ ⊖ IP20  
E14 max 5 x 40W  
012865 SP5

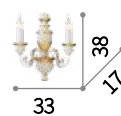

⊕ ⊖ IP20  
E14 max 2 x 40W  
012902 AP2

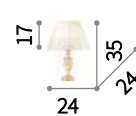

⊕ ⊖ IP20  
E14 max 1 x 40W  
012889 TL1

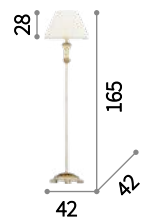

⊕ ⊖ IP20  
E27 max 1 x 60W  
002880 PT1





# Dora

Corpo luce in resina. Bracci e foglie in metallo modellato artigianalmente. Decorato a mano con foglia d'oro e antichizzato.

**ON** Lampada con interruttore integrato  
**OFF** nei modelli: TL1 e PT1.

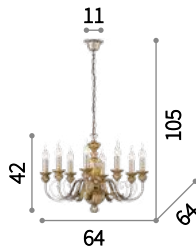

⊕ ⊖ IP20  
E14 max 8 x 40W  
020839 SP8

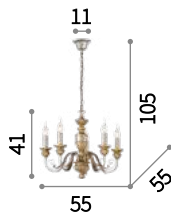

⊕ ⊖ IP20  
E14 max 5 x 40W  
020822 SP5

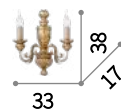

⊕ ⊖ IP20  
E14 max 2 x 40W  
020846 AP2

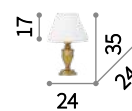

⊕ ⊖ IP20  
E14 max 1 x 40W  
020853 TL1

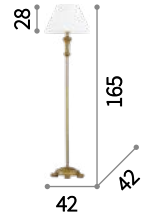

⊕ ⊖ IP20  
E27 max 1 x 60W  
020877 PT1



# Pisa

Montatura e bracci in metallo. Decorato a mano con foglia d'oro e antichizzato.

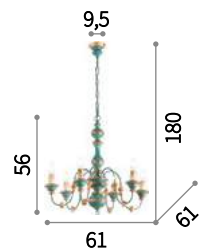

⊕ ⊖ IP20

E14 max 6 x 40W

093550 SP6





# Palio

Corpo luce e dettagli in resina modellata con tecniche artigianali che riproducono fedelmente il legno intagliato. Bracci in metallo. Decorato e antichizzato a mano.

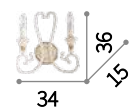
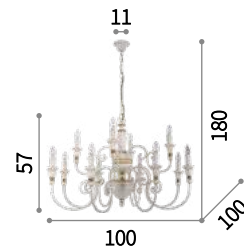

⊕ ⊖ IP20

E14 max 12 x 40W  
093789 SP12 Bianco  
093857 SP12 Ruggine

⊕ ⊖ IP20

E14 max 2 x 40W  
093758 AP2 Bianco  
093796 AP2 Ruggine



093789



093857



# Spiga

Montatura ed elementi decorativi interamente in metallo rifinito argento antichizzato. Paralumi in PVC rivestiti di tessuto.

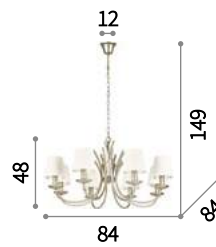

⊕ ⊖ IP20

E14 max 8 x 40W

168838 SP8

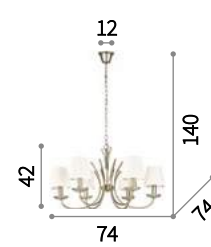

⊕ ⊖ IP20

E14 max 6 x 40W

168821 SP6

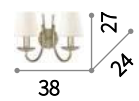

⊕ ⊖ IP20

E14 max 2 x 40W

168791 AP2





# Justine

Rosone e montatura in metallo con bracci in fusione. Rifinito con vernice opaca. Copricatena in velluto.

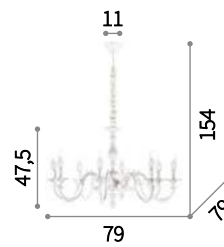

⊕ ⊖ IP20

E14 max 8 x 40W

197524 SP8

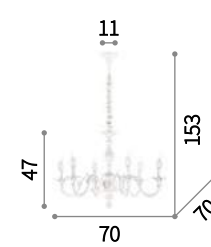

⊕ ⊖ IP20

E14 max 6 x 40W

197500 SP6



⊕ ⊖ IP20

E14 max 2 x 40W

197487 AP2





# Camilla

Montatura ed elementi decorativi interamente in metallo modellato artigianalmente e dipinto a mano.

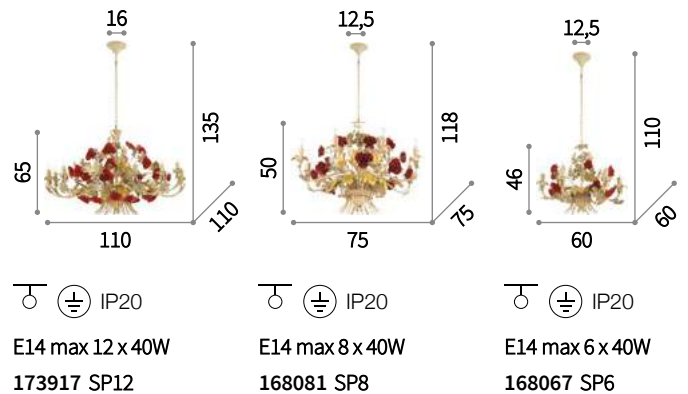





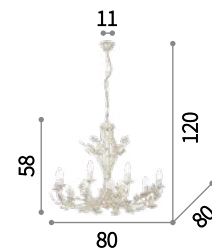

# Champagne

Montatura ed elementi decorativi a foglia in metallo lavorato artigianalmente. Rifinito a mano con vernice color avorio e oro.

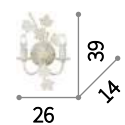

 IP20  
 E14 max 8 x 40W  
 121574 SP8





 IP20  
 E14 max 2 x 40W  
 121864 AP2



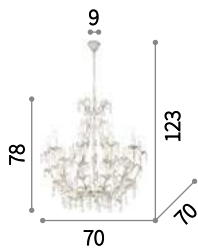

# Cascina

Montatura ed elementi decorativi a foglia in metallo lavorato artigianalmente. Decorato a mano con vernice bianca e oro.



⊕ ⊖ IP20

E14 max 10 x 40W  
100302 SP10

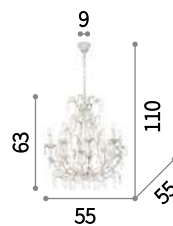

⊕ ⊖ IP20

E14 max 8 x 40W  
100289 SP8

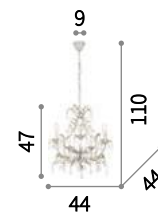

⊕ ⊖ IP20

E14 max 5 x 40W  
100272 SP5

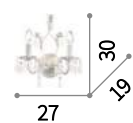

⊕ ⊖ IP20

E14 max 2 x 40W  
100296 AP2





# Corte

Montatura completamente in metallo modellato con lavorazione artigianale. Finitura dipinta a mano con effetto antichizzato.

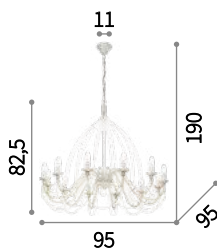

⊕ ⊖ IP20

E14 max 12 x 40W

097664 SP12 Bianco Antico  
097671 SP12 Ruggine

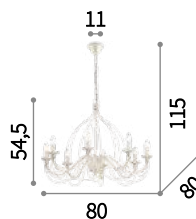

⊕ ⊖ IP20

E14 max 8 x 40W

005898 SP8 Bianco Antico  
057194 SP8 Ruggine



⊕ ⊖ IP20

E14 max 5 x 40W

005881 SP5 Bianco Antico  
057187 SP5 Ruggine

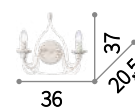

⊕ ⊖ IP20

E14 max 2 x 40W

028460 AP2 Bianco Antico  
057200 AP2 Ruggine



# Sem

Montatura completamente in metallo modellato con lavorazione artigianale. Rifinito con vernice satinata.

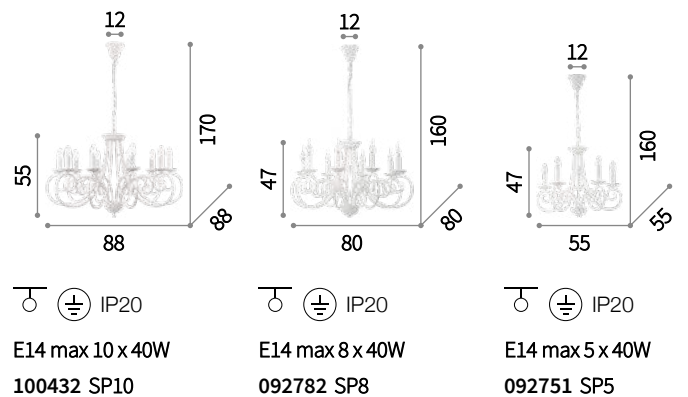





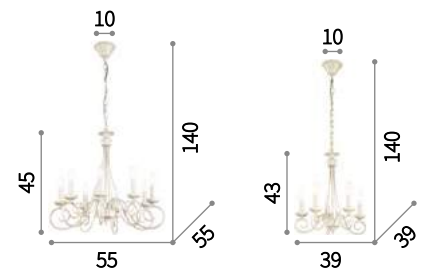

# Brandy

Montatura completamente in metallo modellato con lavorazione artigianale. Dipinto a mano con effetto antichizzato.



 IP20  
 E14 max 8 x 40W  
 066639 SP8



 IP20  
 E14 max 5 x 40W  
 066622 SP5



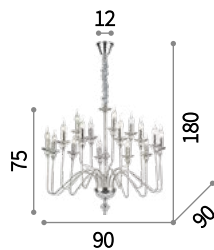

# Artù

Montatura in nickel con finitura lucida.  
 Alle estremità dei bracci, elementi  
 decorativi in cristallo molato. Copricatena  
 in velluto.



⊕ ⊖ IP20

E14 max 16 x 40W  
 073149 SP16

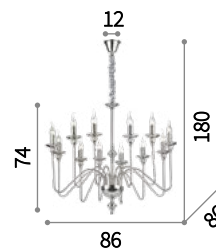

⊕ ⊖ IP20

E14 max 12 x 40W  
 073132 SP12

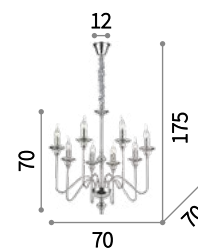

⊕ ⊖ IP20

E14 max 8 x 40W  
 073156 SP8

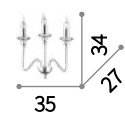

⊕ ⊖ IP20

E14 max 3 x 40W  
 073118 AP3





# Cortina

Montatura in metallo modellato artigianalmente. Elemento centrale e basi porta lampade in resina. Decorato a mano con effetto antichizzato.



⊕ ⊖ IP20

E14 max 10 x 40W

088433 SP10

⊕ ⊖ IP20

E14 max 2 x 40W

088440 AP2





# Tirol

Montatura in metallo decorato a mano in color ruggine. Elementi floreali in vetro trasparente lavorato a pinza. Vetri trasparenti con sfumatura in giallo tenue, rifiniti artigianalmente.

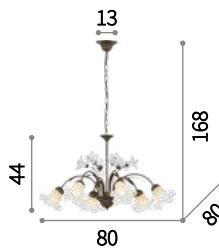

⊕ ⊖ IP20

E14 max 6 x 40W  
024486 SP6



⊕ ⊖ IP20

E14 max 6 x 40W  
024493 PL6

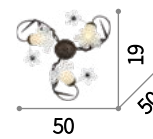

⊕ ⊖ IP20

E14 max 3 x 40W  
024509 PL3

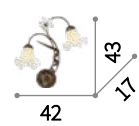

⊕ ⊖ IP20

E14 max 2 x 40W  
024523 AP2









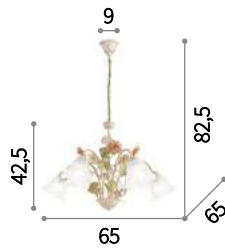

# Valentina

Montatura in metallo lavorato e dipinto a mano in bianco antico con riflessi oro e dettagli in rosa e verde. Vetri satinati.

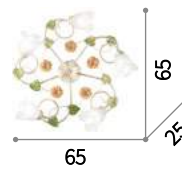





 IP20  
 E14 max 5 x 40W  
 220659 SP5

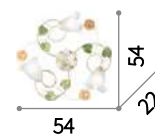



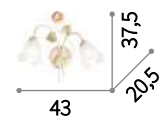

 IP20  
 E14 max 5 x 40W  
 220635 PL5





 IP20  
 E14 max 3 x 40W  
 220628 PL3







 IP20  
 E14 max 2 x 40W  
 220642 AP2



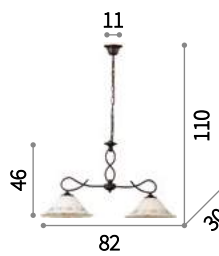

# Foglia

Montatura in metallo decorato a mano di colore nero. Diffusore in vetro centrifugato con decorazioni in rilievo dipinte a mano.







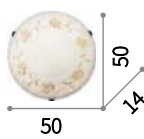

 IP20  
 E27 max 2 x 60W  
 021416 SP2





 IP20  
 E27 max 1 x 60/100W  
 007533 SP1 D40  
 021430 SP1 D50

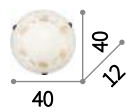







 IP20  
 E27 max 3 x 60W  
 013817 PL3









 IP20  
 E27 max 2 x 60W  
 013800 PL2

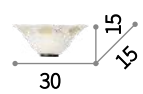



 IP20  
 E27 max 1 x 60W  
 013794 PL1



 IP20  
 E27 max 1 x 60W  
 013787 AP1











# Rondo

Montatura in metallo con finitura in brunito. Diffusore in lastre di vetro trasparente. Cavo in acciaio regolabile in lunghezza.

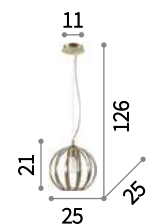

 IP20  
 E27 max 1 x 60W  
 168968 SP1 D40







 IP20  
 E27 max 1 x 60W  
 168951 SP1 D25



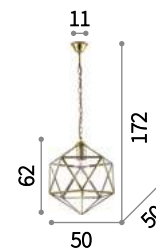

# Deca

Montatura in metallo con finitura in brunito. Diffusore in lastre di vetro trasparente, apribile per sostituzione lampadina.

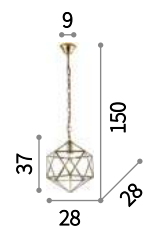

 IP20  
 E27 max 1 x 60W  
 168869 SP1 Big



 IP20  
 E27 max 1 x 60W  
 168852 SP1 Small

004426



# Norma

Montatura in metallo con finitura in cromo o in brunito. Diffusore composto da lastre di vetro trasparente con bordo molato. Copricatena in velluto.



E27 max 1x60W

005911 SP1 Brunito  
094786 SP1 Cromo

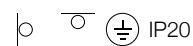
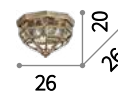

E14 max 3x40W

004426 PL3 Brunito  
094793 PL3 Cromo



E27 max 1x60W

004419 AP1 Brunito  
100425 AP1 Cromo



094786

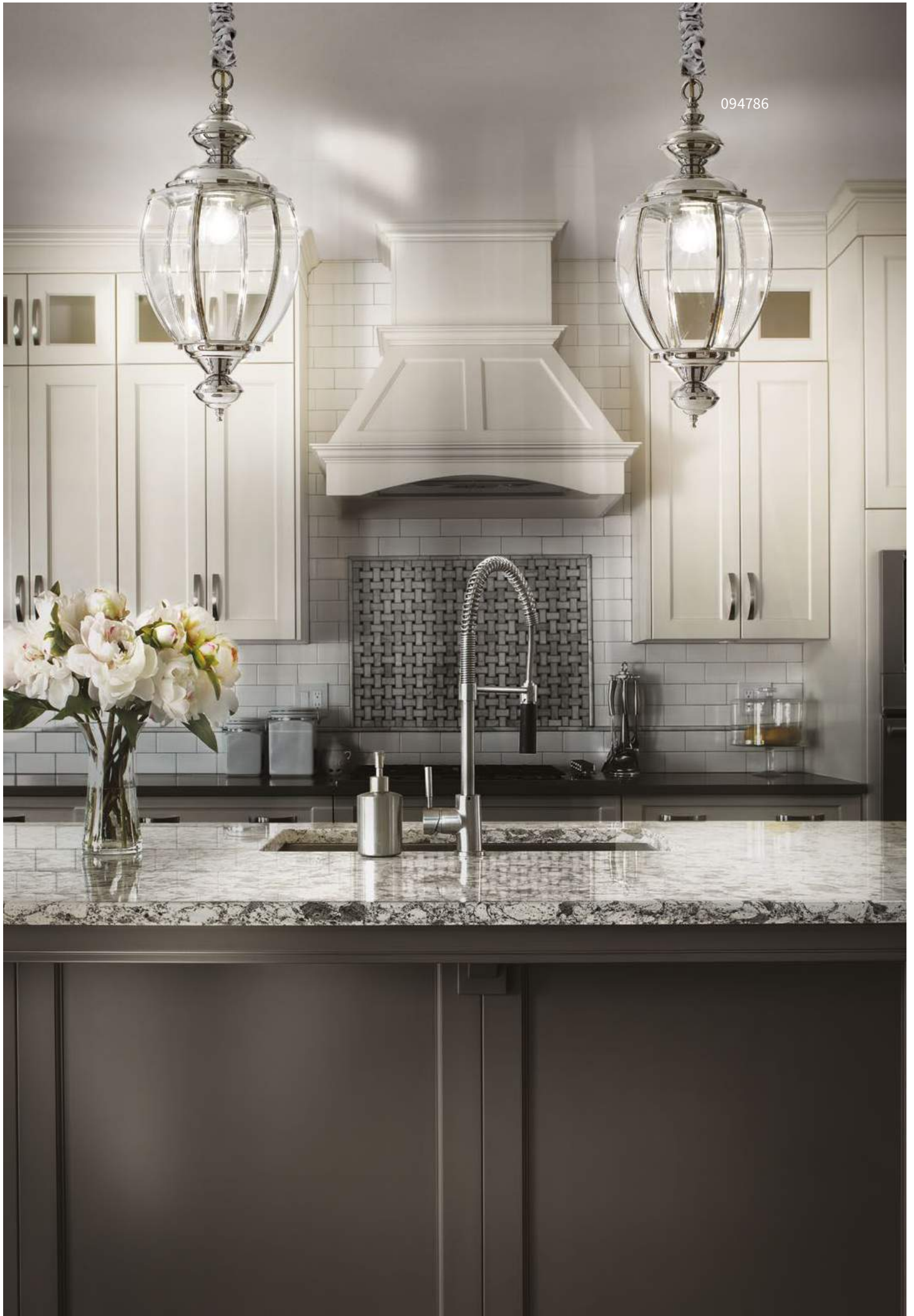



# Stella

Montatura in metallo modellata artigianalmente. Diffusore composto di lastre di vetro trasparente incastonate nella struttura metallica. Porzione apribile per la sostituzione della lampadina.

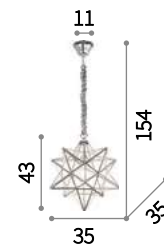

⊕ ⊖ IP20  
E27 max 1 x 60W  
093079 SP1 Big

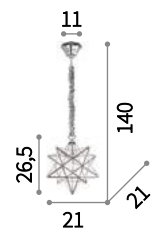

⊕ ⊖ IP20  
E27 max 1 x 60W  
093000 SP1 Small









# Orangerie

Montatura in metallo rifinito brunito.  
 Diffusore in lastre di vetro trasparente.  
 Cavo in tessuto nero.

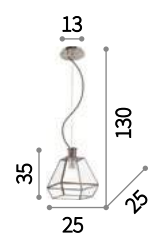

 IP20  
 E27 max 1 x 60W  
 160085 SP1 Big





 IP20  
 E27 max 1 x 60W  
 152776 SP1 Small

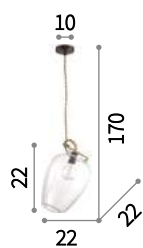

# Potty

Rosone in metallo verniciato nero opaco. Cavo rivestito in corda. Diffusori con vasi in vetro soffiato trasparente.



⊕ ⊞ IP20

E27 max 1 x 60W

158709 Potty-1 SP1

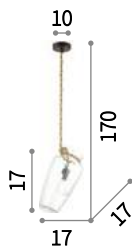

⊕ ⊞ IP20

E27 max 1 x 60W

158785 Potty-2 SP1

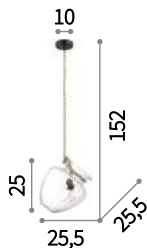

⊕ ⊞ IP20

E27 max 1 x 60W

158808 Potty-3 SP1





158785

158808

158709







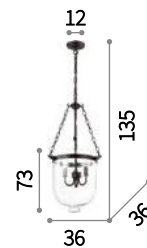

# Entry

Montatura e dettagli in metallo rifinito con vernice nera opaca. Diffusore in vetro soffiato trasparente.

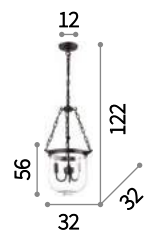

 IP20  
 E14 max 3 x 40W  
 134215 SP3 Big



 IP20  
 E14 max 3 x 40W  
 134208 SP3 Small





# Anfora

Montatura in metallo sagomato artigianalmente e smaltato nero. Diffusore in vetro trasparente soffiato a mano.



Lampadine ALO G9 28W 2700 K incluse nel modello AP1.

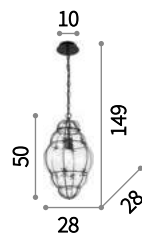

⊕ ⊖ IP20

E27 max 1 x 42W

131795 SP1 Big

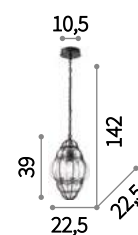

⊕ ⊖ IP20

E27 max 1 x 42W

131788 SP1 Small

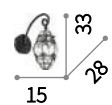

⊕ ⊖ IP20 

G9 max 1 x 28W

131771 AP1



# Kyoto

Rosone e montatura in metallo verniciato nero opaco. Diffusore con lastre di vetro trasparente satinato.



⊕ ⊖ IP20

E27 max 1 x 60W

208282 SP1 Medium

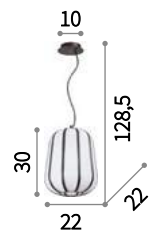

⊕ ⊖ IP20

E27 max 1 x 60W

208299 SP1 Small







# Maglie

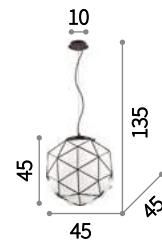

Rosone e montatura a gabbia in metallo verniciato nero opaco. Diffusore in vetro bianco soffiato artigianalmente.

**ON** Lampada con interruttore integrato  
**OFF** nel modello TL1.

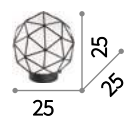

 IP20  
 E27 max 1 x 60W  
 159263 SP1 D45



 IP20  
 E27 max 1 x 60W  
 159317 TL1 D25



# Parete e soffitto









# Mozart

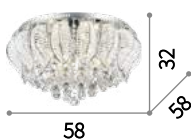

Montatura in metallo cromato. Elementi decorativi con file di perle in cristallo.  
Pendagli con ottagoni e sfere in cristallo molato.

 Lampadine ALO G9 28W 2700 K incluse.



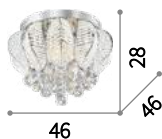



  IP20   
G9 max 9 x 40W  
073613 PL9

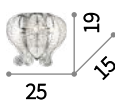

  IP20   
G9 max 6 x 40W  
073606 PL6



   IP20   
G9 max 3 x 40W  
015767 AP3





# Fiore

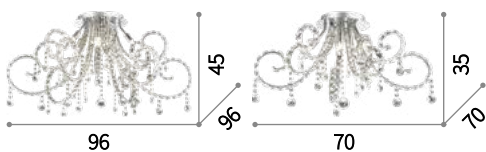

Montatura e porta lampade in metallo cromato. Elementi decorativi quadrati in cristallo molato.

 Lampadine ALO G9 28W 2700 K incluse.

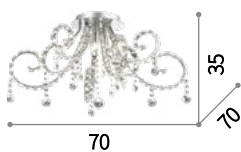

  IP20   
G9 max 10 x 40W  
089454 PL10



  IP20   
G9 max 6 x 40W  
089430 PL6











# Bijoux

Montatura circolare e portalampade in metallo cromato. Elementi decorativi con catene di ottagoni e pendagli finali a sfera in cristallo molato.

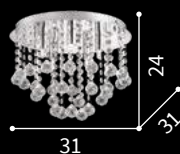



Lampadine ALO G9 28W 2700 K incluse.







 IP20
 
  
 G9 max 5 x 40W  
**089485 PL5**





 IP20
 
  
 G9 max 4 x 40W  
**089478 PL4**



 IP20
 
  
 G9 max 3 x 40W  
**089461 PL3**

# Tintoretto

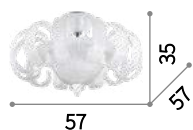
Montatura in metallo cromato.  
Diffusore ed elementi decorativi in vetro  
trasparente modellato a mano e rifinito  
con graniglia.



⊕ IP20

E14 max 4 x 40W

103440 PL4



# Tiziano

Diffusore di vetro trasparente lavorato  
in piastra e decorato all'interno con  
graniglia. Disponibile trasparente con  
dettaglio cromato o ambra con dettaglio  
ottonato.

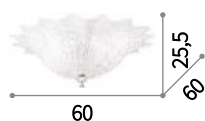

⊕ IP20

E14 max 5 x 40W

142364 PL5 Ambra

142357 PL5 Trasparente



# Shell

Diffusore di vetro trasparente lavorato in piastra e decorato all'interno con graniglia. Blocca vetro con dettaglio in metallo. Disponibile trasparente con dettaglio cromato o ambra con dettaglio ottonato.

140186

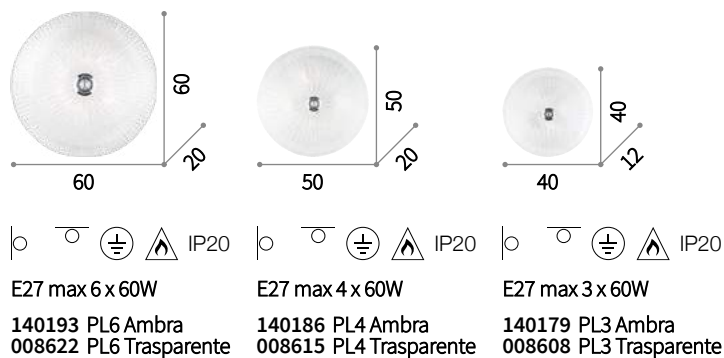





# Fiocco

Diffusore di vetro trasparente lavorato in piastra con graniglia. Decoro centrale color ambra. Viti fermavetro in ottone satinato.

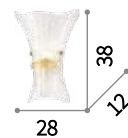

⌀  $\varnothing$  IP20  
E27 max 1 x 60W  
014630 AP1 Big

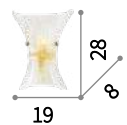

⌀  $\varnothing$  IP20  
E14 max 1 x 40W  
014623 AP1 Small



# Ape

Diffusore di vetro trasparente lavorato in piastra, decorato con graniglia bianca nella zona centrale e ambra nelle parti laterali. Viti fermavetro in cromo.

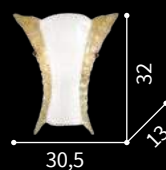

⊕ ⊖ IP20  
E27 max 1 x 60W  
**002903** AP1 Big



⊕ ⊖ IP20  
E14 max 1 x 40W  
**002897** AP1 Small

# Stones

Montatura in metallo smaltato bianco.  
Diffusore interamente realizzato con  
elementi in alabastro naturale, aperto  
sulle estremità superiore e inferiore.



⌀  IP20  
E27 max 2 x 60W  
015132 AP2

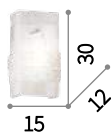

⌀  IP20  
E27 max 1 x 60W  
015125 AP1

# Scacchi

Montatura in metallo smaltato bianco.  
Diffusore interamente realizzato con  
elementi in alabastro naturale, aperto  
sulle estremità superiore e inferiore.

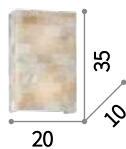

⌀  IP20  
E27 max 2 x 60W  
015118 AP2



⌀  IP20  
E27 max 1 x 60W  
015101 AP1









# Carrara

Diffusore interamente realizzato con elementi in alabastro, aperto sulle estremità superiore e inferiore.





Lampadine ALO G9 28W 2700 K incluse.



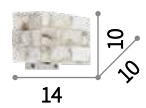

  
 G9 max 2 x 40W  
 018775 AP2







  
 G9 max 1 x 40W  
 000619 AP1

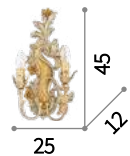

# Carmen

Corpo luce in resina modellata con tecniche artigianali. Decorato e antichizzato a mano con foglia d'oro e vernice argentata.



⊕ IP20

E14 max 2 x 40W

093703 AP2



# Winery

Corpo luce con portalampade incorporato interamente in ceramica smaltata. Modello AP con assetto inclinato verso il basso.

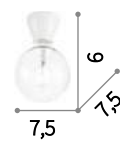

E27 max 1 x 60W

E27 max 1 x 60W

155227 PL1 Bianco  
155142 PL1 Nero

180298 AP1 Bianco  
180304 AP1 Nero





180212

# Limbo

Diffusore orientabile in metallo verniciato opaco. Supporto a morsetto in metallo. Cavo con interruttore e spina.



180229

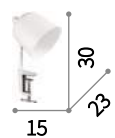

⊙ □ IP20

E27 max 1x60W

180212 AP1 Bianco  
180229 AP1 Nero



179643

# Shower

Montatura in metallo verniciato opaco.  
Elemento snodato in cromo. Diffusore orientabile.  
Cavo in tessuto con interruttore e spina.

**ON**  
**OFF** Lampada con interruttore integrato.



179667

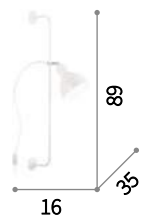

IP20

E27 max 1x60W

179667 AP1 Bianco  
179643 AP1 Nero





139951

# Astrid

Montatura in metallo con finitura in brunito o vernice nera opaca. Diffusore in vetro trasparente.



140001

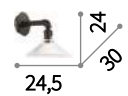

⊕ IP20

E27 max 1x60W

140001 AP1 Brunito  
139951 AP1 Nero





159997

## Barber

Base, snodo e copri portalampane interamente in metallo. Corpo luce inclinabile.

**LED** Lampadine LED GU10 5W 3000 K incluse. Cod. 108292



160016

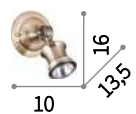

GU10 max 1x28W  
 159997 AP1 Brunito  
 160016 AP1 Nickel

# Arco

Montatura in metallo con finitura disponibile in cromo, brunito o nickel.  
Diffusore in tubolare di vetro pirex trasparente con schermo in rete metallica all'interno.

 Lampadine ALO R7s 120W 118 mm  
2700 K incluse.



 008929

 008905

 008912



R7s max 1 x 150W

008929 AP1 Brunito  
008905 AP1 Cromo  
008912 AP1 Nickel

# Lucciola

Montatura interamente in metallo,  
disponibile con finitura in cromo, nickel  
o brunito. Diffusore in vetro trasparente  
acidato.

 Lampadine ALO R7s 80W 78 mm  
2700 K incluse.

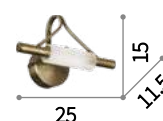

R7s max 1 x 100W

119755 AP1 Brunito  
013275 AP1 Cromo  
004358 AP1 Nickel

 119755

 013275

 004358

# Cico

Montatura in metallo con finitura disponibile in cromo, brunito o nickel.  
Diffusori indipendenti tra loro e posizionabili.

 Lampadine ALO G9 28W 2700 K incluse.

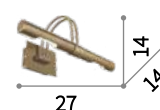

  IP20 

G9 max 2 x 40W

014456 AP2 Brunito  
014432 AP2 Cromo  
014449 AP2 Nickel

 014456

 014432

 014449

# Dynamo

Montatura e braccio flessibile in metallo con finitura disponibile in cromo, nickel e brunito. Diffusore orientabile a piacere. Dotato di interruttore sulla base.

 Sorgente luminosa LED 4000 K, 20.000 h di durata.

 Lampada con interruttore integrato.

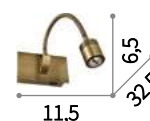

  IP20

LED 3W / 200 Lm

121352 AP1 Brunito  
031460 AP1 Cromo  
031477 AP1 Nickel

 121352

 031460

 031477





# Bow

Montatura in metallo con finitura disponibile in bianco, brunito, cromo, nickel o ottone satinato. Diffusore a LED inclinabile. Interruttore sulla base.

**LED** Sorgente luminosa LED 3000 K, 20.000 h di durata.

**ON OFF** Lampada con interruttore integrato.

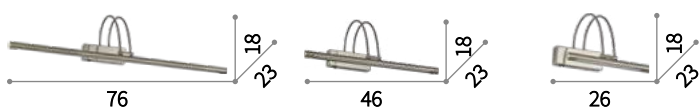

⊙ ⊕ IP20

LED 7,98W / 450 Lm

137612 AP114 Bianco  
121147 AP114 Brunito  
007021 AP114 Cromo  
007069 AP114 Nickel  
121130 AP114 Ottone Sat.

⊙ ⊕ IP20

LED 4,62W / 250 Lm

137605 AP66 Bianco  
121161 AP66 Brunito  
007045 AP66 Cromo  
007038 AP66 Nickel  
121178 AP66 Ottone Sat.

⊙ ⊕ IP20

LED 2,52W / 150 Lm

137599 AP36 Bianco  
121338 AP36 Brunito  
005386 AP36 Cromo  
005379 AP36 Nickel  
121154 AP36 Ottone Sat.

121147







# Retrò

Montatura e diffusore interamente in metallo con finitura brunito. Diffusore orientabile.

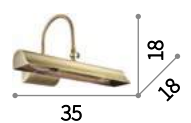

⊕ IP20

E14 max 2 x 28W

144917 AP2





# Mirror-10

Montatura in metallo con finitura disponibile in brunito, cromo o nickel. Diffusore posizionabile.



Lampadine ALO G9 28W 2700 K incluse.



017310



017303



017297

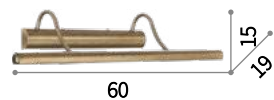

G9 max 4 x 40W

017310 AP4 Brunito  
017303 AP4 Cromo  
017297 AP4 Nickel



# Mirror-20

Montatura in metallo con finitura disponibile in brunito, in cromo o in ottone. Diffusore regolabile.



Lampadine ALO G9 28W 2700 K incluse.



Lampada con interruttore integrato.

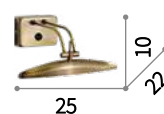

⊕ ⊖ IP20 

G9 max 2 x 40W

017327 AP2 Brunito  
017334 AP2 Cromo  
031507 AP2 Ottone







# Bob Mini

Montatura in metallo decorato effetto ruggine. Diffusori orientabili con raccordo di cavo in tessuto e gabbietta metallica nera.

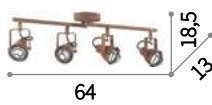

IP20  
 GU10 max 4 x 25W  
 155494 PL4

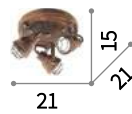

IP20  
 GU10 max 3 x 25W  
 156415 PL3

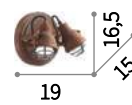

IP20  
 GU10 max 2 x 25W  
 156408 AP2

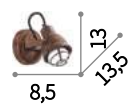

IP20  
 GU10 max 1 x 25W  
 156392 AP1





# Maracas

Montatura interamente in metallo rifinito in ottone satinato. Diffusori orientabili in vetro soffiato trasparente.

**LED** Lampadine LED G4 2W 3000 K incluse. Cod. 222257

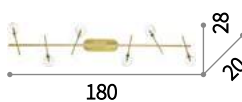

G4 max 6 x 2W  
200361 PL6

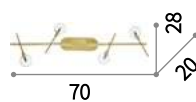

G4 max 4 x 2W  
200354 PL4

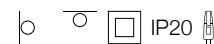
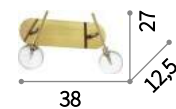

G4 max 2 x 2W  
200347 AP2

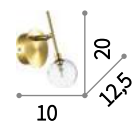

G4 max 1 x 2W  
200330 AP1







# Alfa

Montatura in metallo con finitura in cromo, brunito, bianco satinato o nickel satinato. Corpo luce posizionabile con rotazione dello stelo e snodo per l'inclinazione.

 Lampadine ALO GU10 28W 2700 K incluse.

089560











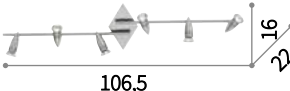
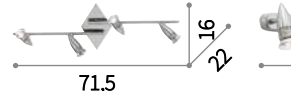
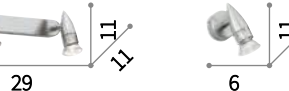









009377



099057



			
<p>106,5</p> <p>22</p> <p>16</p>	<p>71,5</p> <p>22</p> <p>16</p>	<p>29</p> <p>11</p> <p>11</p>	<p>6</p> <p>11</p> <p>11</p>
<p>   IP20 </p> <p>GU10 max 6 x 50W</p> <p>122748 PL6 Bianco</p> <p>119908 PL6 Brunito</p> <p>089591 PL6 Cromo</p> <p>006338 PL6 Nickel</p>	<p>   IP20 </p> <p>GU10 max 4 x 50W</p> <p>122731 PL4 Bianco</p> <p>119830 PL4 Brunito</p> <p>089584 PL4 Cromo</p> <p>006321 PL4 Nickel</p>	<p>   IP20 </p> <p>GU10 max 2 x 50W</p> <p>122717 AP2 Bianco</p> <p>119816 AP2 Brunito</p> <p>089577 AP2 Cromo</p> <p>009483 AP2 Nickel</p>	<p>   IP20 </p> <p>GU10 max 1 x 50W</p> <p>099057 AP1 Bianco</p> <p>119786 AP1 Brunito</p> <p>089560 AP1 Cromo</p> <p>009377 AP1 Nickel</p>



119786



# Bossanova

Faretto da incasso fisso con montatura in metallo cromato. Elementi decorativi con ottagoni e puntali in cristallo molato trasparente.



GU10 max 1 x 50W

107684 FI1



# Polka

Faretto da incasso fisso con montatura in metallo cromato. Elemento decorativo esterno in gesso con finitura in brunito, ottone o con vernice opaca bianca.

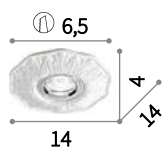

GU10 max 1 x 50W

115597 FI1 Bianco  
115580 FI1 Brunito  
115610 FI1 Ottone





# Soul

Faretto da incasso fisso con montatura in metallo cromato. Elemento decorativo esterno in cristallo molato trasparente.

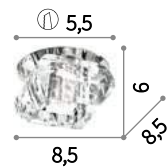

IP20  
 G9 max 1x40W  
 107691 Soul-1 FI1

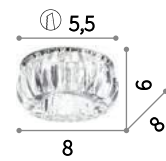

IP20  
 G9 max 1x40W  
 107707 Soul-2 FI1

# Tavolo e terra











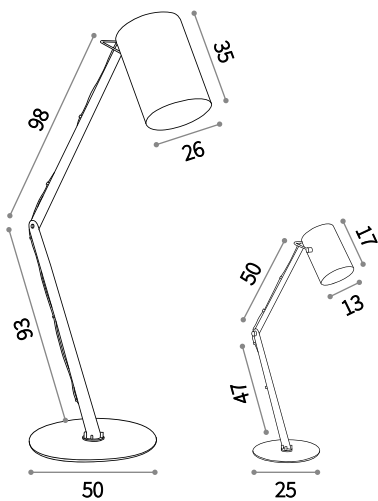

# Bin

Montatura e diffusore in metallo rifinito con vernice opaca. Braccio snodato regolabile. Diffusore orientabile.

 Lampada con interruttore integrato.



	
  IP20	  IP20
E27 max 1 x 42W	E27 max 1 x 42W
144856 TL1 Bianco	144818 PT1 Bianco
144863 TL1 Nero	144849 PT1 Nero



144849









# Reflector

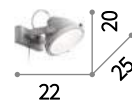

Montatura in metallo verniciato con effetto invecchiato. Diffusore orientabile con vetro trasparente stampato tipo auto d'epoca.

 Lampada con interruttore integrato nel modello PT1.

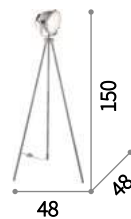

  IP20  
E27 max 1 x 40W  
155630 AP1



  IP20  
E27 max 1 x 40W  
155623 PT1

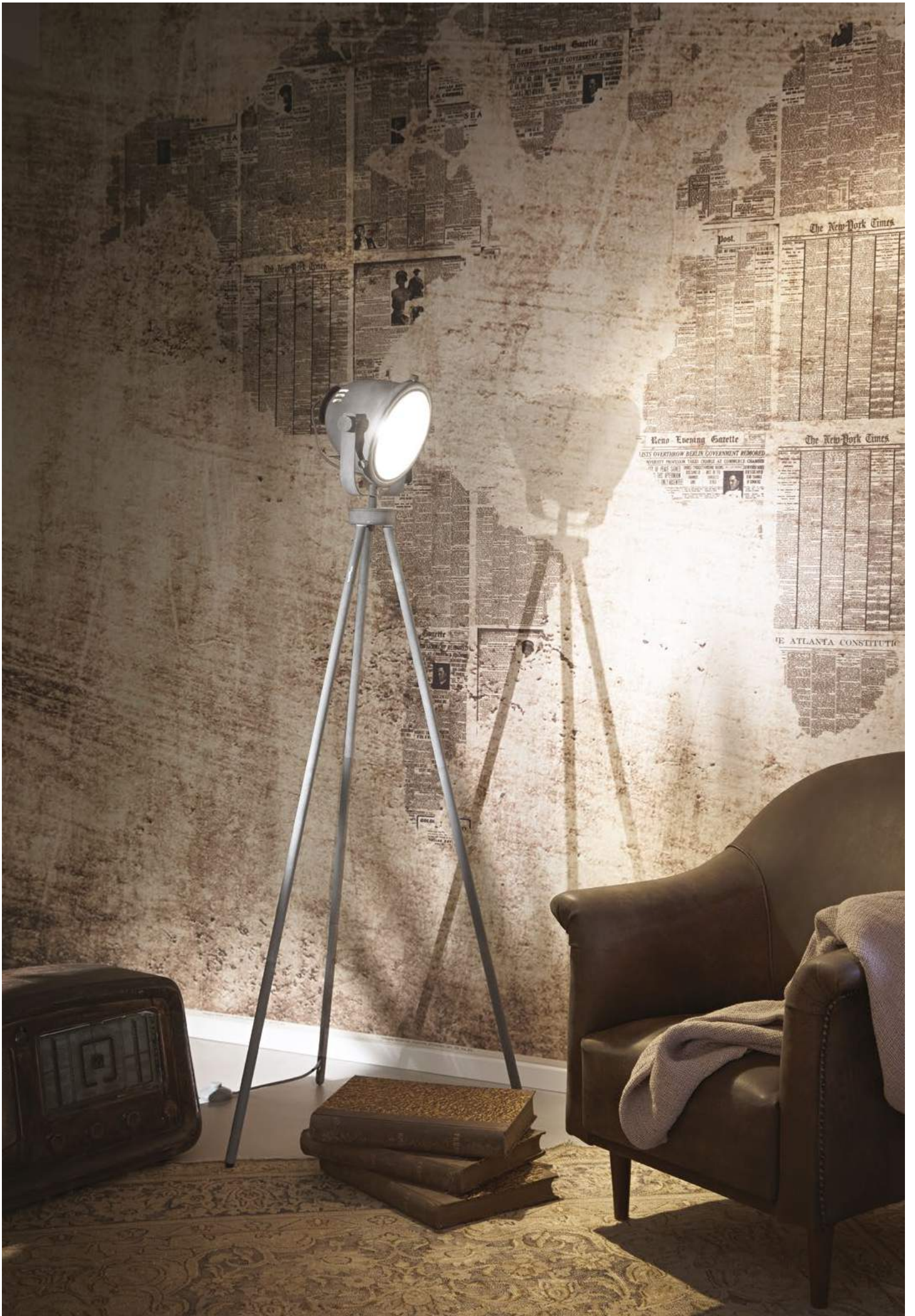





# Torchio

Treppiede e diffusore in listelli di legno naturale invecchiato. Regolabile in altezza con raccordi in metallo verniciato nero. Diffusore orientabile con dettagli in metallo verniciato nero opaco.

**ON**  
**OFF** Lampada con interruttore integrato.



♀ □ IP20  
E27 max 1x60W  
133959 PT1





# Kraken

Treppiede in legno verniciato nero opaco. Dettagli e corpo luce in metallo cromato. Diffusore in vetro trasparente con alette interne per l'orientamento del flusso luminoso.



Lampada con interruttore integrato.



♀ □ IP20  
E27 max 1x60W  
105659 PT1





145204

# Truman

Montatura e diffusore in metallo rifinito con vernice opaca. Braccio snodato con raccordi in metallo brunito. Diffusore smaltato bianco all'interno. Cavo rivestito in tessuto vintage bianco e nero.



Lampada con interruttore integrato.



145198

145211

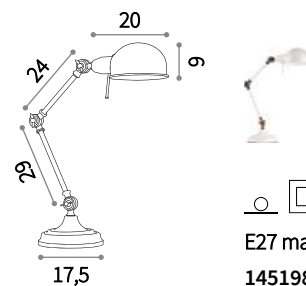

IP20

E27 max 1x60W

145198 TL1 Bianco

145204 TL1 Grigio

145211 TL1 Nero



# Maurien

Montatura interamente in metallo verniciato a polveri. Diffusori orientabili e regolabili in altezza.

**ON**  
**OFF** Lampada con interruttore integrato.



○ □ IP20  
E27 max 1 x 42W  
199535 TL1

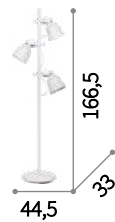

○ □ IP20  
E27 max 3 x 42W  
199528 PT3



# Mermaid

Montatura interamente in metallo con  
finitura cromo o bianco antichizzato.  
Diffusori in vetro trasparente.

 Lampada con interruttore integrato.



166650



E27 max 1 x 60W



E27 max 1 x 60W

166766 TL1 Big Bianco Antico 166742 TL1 Small Bianco Antico  
166667 TL1 Big Cromo 166650 TL1 Small Cromo



166742



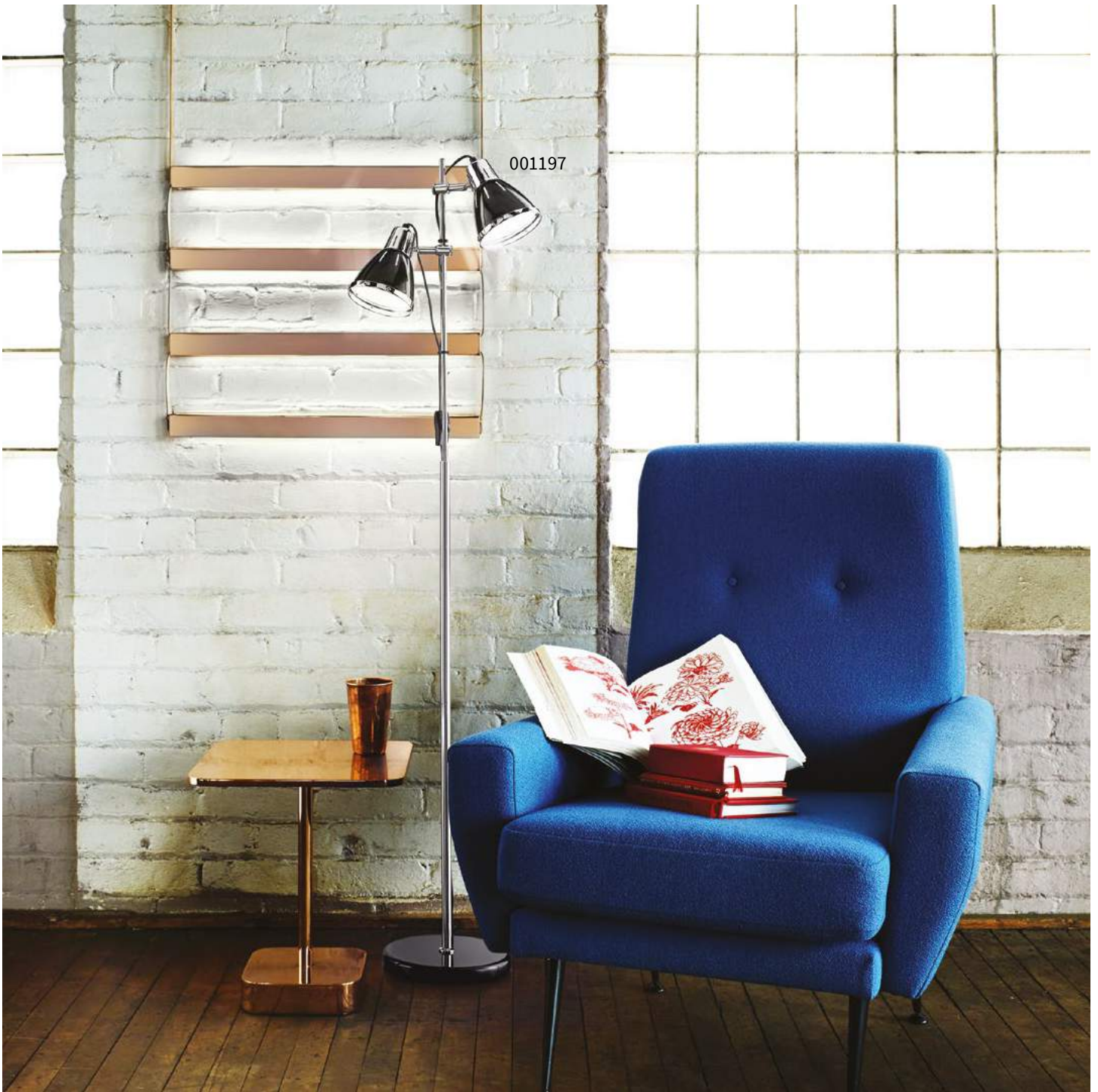

# Elvis

Montatura in metallo cromato. Diffusore orientabile in metallo colorato e dettagli in cromo all'esterno, smaltato bianco all'interno.

**ON**  
**OFF** Lampada con interruttore integrato.



034416



○ □ IP20  
E27 max 1 x 60W

034416 TL1 Argento  
034393 TL1 Nero

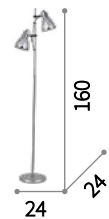

○ □ IP20  
E27 max 2 x 60W

042794 PT2 Argento  
001197 PT2 Nero





# Alfiere

Corpo luce in metallo cromato. Paralume in lamina di PVC in colore cromo semitrasparente.

**ON** / **OFF** Lampada con interruttore integrato.



○ □ IP20  
E27 max 1 x 60W  
032436 TL1 Big

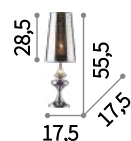

○ □ IP20  
E27 max 1 x 60W  
032467 TL1 Small







# Drill

Montatura interamente in metallo rifinito in cromo. Diffusore fisso. Braccio mobile con snodi.

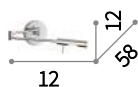
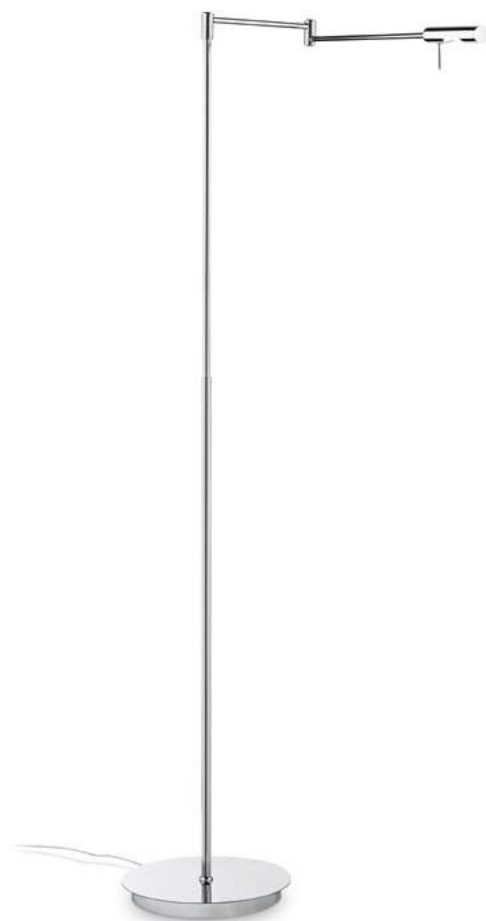

 Lampadine ALO G9 28W 2700 K incluse.

 Lampada con interruttore integrato nei modelli: TL1 e PT1.



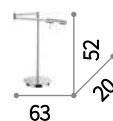

  IP20   
G9 max 1 x 28W  
153599 AP1

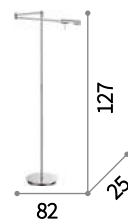

  IP20   
G9 max 1 x 28W  
153636 TL1



  IP20   
G9 max 1 x 28W  
153612 PT1







# Beverly

Montatura in metallo con finitura in ottone satinato o in cromo. Braccio snodato regolabile. Paralume in lamina di PVC rivestito in tessuto.

**ON** Lampada con interruttore integrato  
**OFF** nei modelli: TL1 e PT1.



⊙ ⊕ IP20

E14 max 1 x 40W

126784 AP1 Cromo  
140247 AP1 Ottone Satinato

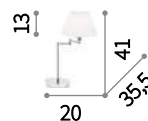

⊙ ⊕ IP20

E14 max 1 x 40W

126760 TL1 Cromo  
140322 TL1 Ottone Satinato

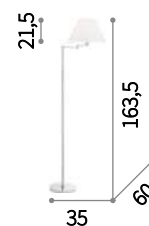

♀ ⊕ IP20

E27 max 1 x 60W

126807 PT1 Cromo  
140315 PT1 Ottone Satinato





# Step



Corpo luce in metallo cromato decorato con sfere di vetro. Paralume in lamina di PVC rivestita di tessuto bianco con fantasia floreale in rilievo.

 Lampada con interruttore integrato.



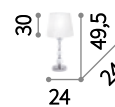

  IP20  
E27 max 1x60W  
026862 TL1 Big

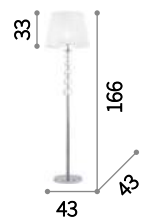

  IP20  
E27 max 1x60W  
026855 TL1 Small



  IP20  
E27 max 1x100W  
032313 PT1



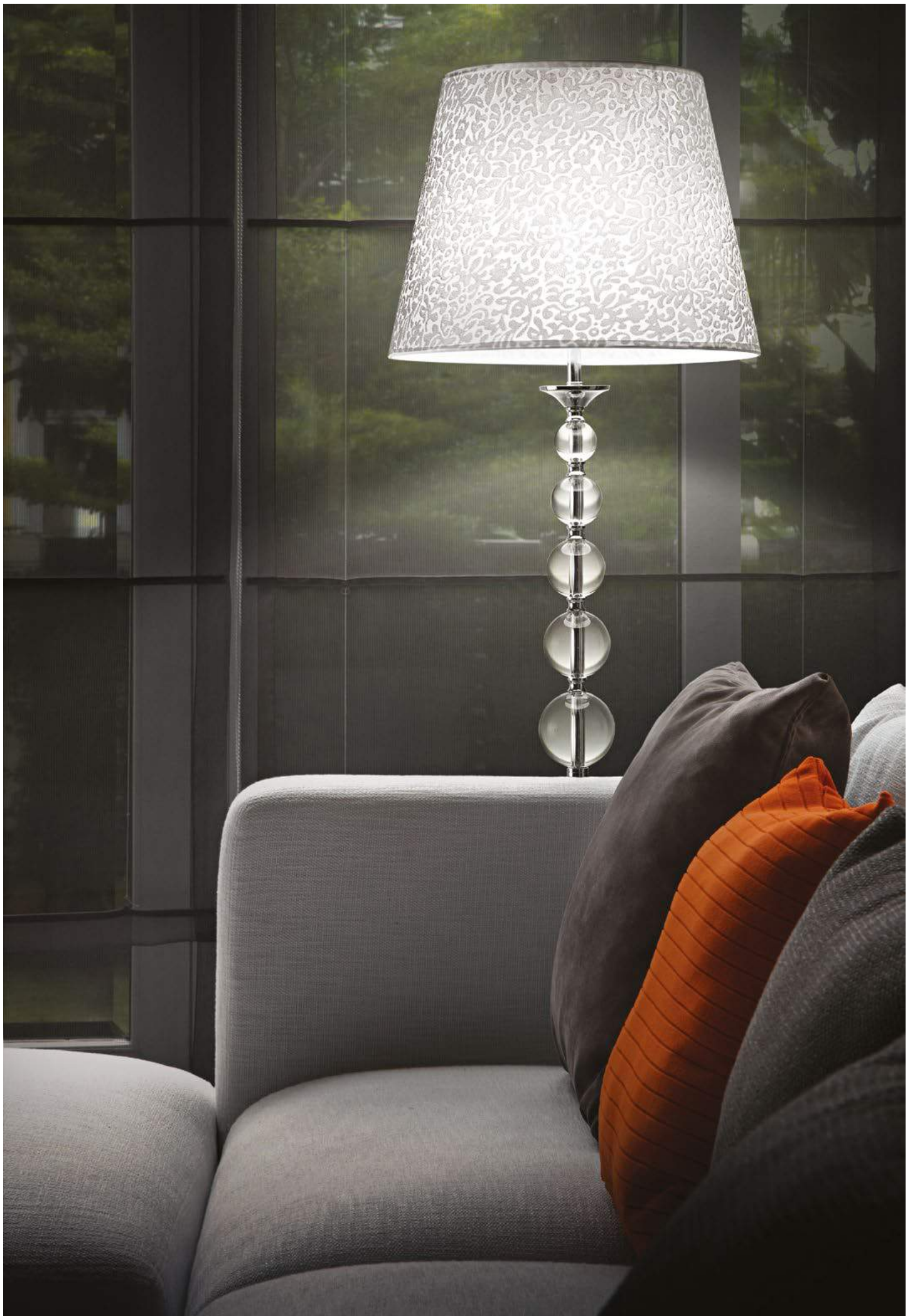



# Forcola

Montatura e dettagli in metallo cromato.  
Corpo luce in vetro trasparente soffiato  
e lavorato a mano. Diffusore in lamina di  
PVC rivestita di tessuto.

**ON**  
**OFF** Lampada con interruttore integrato.

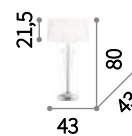

⊙ □ IP20  
E27 max 1 x 60W  
142593 TL1



⊙ □ IP20  
E27 max 1 x 60W  
142616 PT1





# Dorothy

Base e struttura centrale in metallo cromato. Elementi decorativi in vetro soffiato e lavorato a mano. Paralume in lamina di PVC, rivestita in tessuto.

**ON**  
**OFF** Lampada con interruttore integrato.

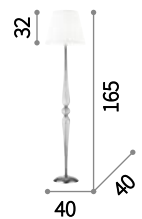

♀ □ IP20

E27 max 1x100W

100982 PT1 Bianco  
035369 PT1 Trasparente





# Magic

Base e corpo luce con elementi in cristallo molato e dettagli metallici con finitura in cromo. Paralume in tessuto bianco plissettato.

**ON**  
**OFF** Lampada con interruttore integrato.



○ □ IP20  
E27 max 1 x 60W  
014920 TL1 Small

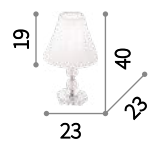

○ □ IP20  
E27 max 1 x 60W  
016016 TL1 Mini



# Kate

Corpo luce con elementi di cristallo pieno molato trasparente. Paralumi in tessuto doppio disponibili nella versione squadrata o rotonda.

**ON**  
**OFF** Lampada con interruttore integrato.



○ □ IP20  
E27 max 1 x 60W

122878 Kate-3 TL1 Round



○ □ IP20  
E27 max 1 x 60W

110516 Kate-3 TL1 Square



○ □ IP20  
E27 max 1 x 60W

122885 Kate-2 TL1 Round

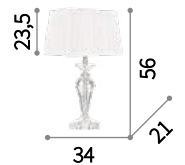

○ □ IP20  
E27 max 1 x 60W

110509 Kate-2 TL1 Square





001180

# Voga

Base e corpo luce in vetro trasparente soffiato e lavorato a mano. Diffusore in lamina di PVC rivestita di tessuto.

**ON**  
**OFF** Lampada con interruttore integrato.



087382



○ □ IP20

E27 max 1x60W

001180 TL1 Bianco  
087382 TL1 Nero





# Duchessa

Base e dettagli in metallo cromato.  
Elementi decorativi in vetro soffiato e  
lavorato a mano. Paralume in tessuto di  
organza plissettato.

**ON**  
**OFF** Lampada con interruttore integrato.

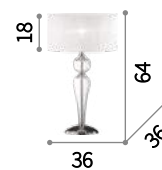

○ □ IP20  
E27 max 1 x 60W  
044491 TL1 Big

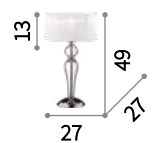

○ □ IP20  
E27 max 1 x 60W  
051406 TL1 Small



# Lilly Table

Lampada in vetro soffiato trasparente e colorato lavorato artigianalmente. Dettagli in metallo cromato.

 Lampada con interruttore integrato.



 IP20  
E27 max 1x60W  
026084 TL1



# Eternity

Base in fusione di metallo. Finitura cromo con paralume di organza plissettata e riflessi metallizzati.



Lampada con interruttore integrato.

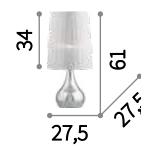

○ □ IP20  
E27 max 1 x 60W  
036007 TL1 Big

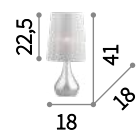

○ □ IP20  
E14 max 1 x 40W  
035987 TL1 Small





# Snell

Base in legno naturale. Corpo luce formato da rami veri. Paralume in lamina di pvc rivestita di tessuto.



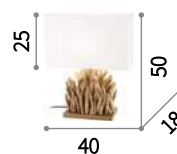

Lampada con interruttore integrato.

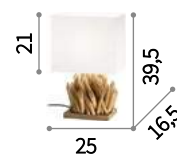

  IP20  
E27 max 1 x 60W  
201399 TL1 Big



  IP20  
max 1 x 60W E27  
201382 TL1 Small





# Dolomiti

Corpo luce con elementi in ceramica smaltati. Dettagli metallici in nickel satinato. Paralume in lamina di PVC rivestita di tessuto tipo lino di colore beige.

**ON**  
**OFF** Lampada con interruttore integrato.

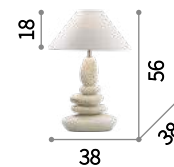

○ □ IP20  
E27 max 1 x 60W  
034942 TL1 Big



○ □ IP20  
max 1 x 60W E27  
034935 TL1 Small





## Biva-50

Corpo luce in resina decorato a mano e finale in metallo cromato. Paralume in doppio tessuto: bianco all'interno e plissettato in color canapa all'esterno.

**ON**  
**OFF** Lampada con interruttore integrato.

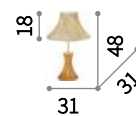

⊙ □ IP20  
E27 max 1 x 60W  
017716 TL1

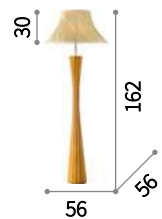

⊙ □ IP20  
E27 max 1 x 60W  
015750 PT1



131733

# Amsterdam

Montatura e diffusore in metallo.  
Disponibile con finitura in cromo o  
brunita. Braccio regolabile in altezza.  
Diffusore orientabile.

**ON**  
**OFF** Lampada con interruttore integrato.



131757



○ □ IP20  
E27 max 1 x 60W

131733 TL1 Brunito  
131757 TL1 Cromo

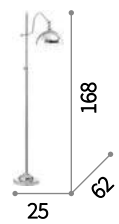

○ □ IP20  
E27 max 1 x 60W

129242 PT1 Brunito  
131719 PT1 Cromo





013657

# Lawyer

Montatura in metallo con finitura disponibile in ottone, in cromo o in brunito. Diffusore in vetro soffiato e incamiciato.

**ON**  
**OFF** Lampada con interruttore integrato.



○ □ IP20

E27 max 1x60W

152684 TL1 All Chrome  
045030 TL1 Brunito  
045047 TL1 Cromo  
013657 TL1 Ottone



# Tecnico

## Profili e tracklights





# Arca

Sistema lineare in alluminio estruso compatibile con un'ampia scelta di apparecchi illuminanti a fissaggio magnetico e blocco meccanico di sicurezza.

Il sistema è anodizzato e verniciato. Disponibile in colore nero e nelle modalità d'installazione a plafone, a sospensione oppure a incasso a filo in soffitti di cartongesso. Moduli componibili a seconda della disposizione desiderata. La sezione della scocca per le versioni a soffitto e a sospensione è larga 42 mm e alta 85 mm, mentre quella per la versione a incasso è larga 86 mm e alta 90 mm. Entrambi i modelli sono disponibili in due lunghezze: 1000 mm e 3000 mm. Possibilità di assemblaggio con diversi moduli sorgente: il modulo WIDE diffondente, il modulo ACCENT con controllo dell'UGR inferiore a 19, i moduli TRACK oppure PENDANT per un'illuminazione SPOT con differenti angoli di emissione.

LED integrati, possibilità di temperatura di colore di 3000 K o di 4000 K; binning iniziale  $\leq 3$ -Step MacAdam; min. 80% di flusso luminoso rimanente dopo 50.000 h di durata; protezione IP20; classe isolamento III.

L'alimentazione in 48V conferisce grande versatilità e sicurezza, con composizioni reversibili e modificabili all'occorrenza. Sistema adatto per ambienti dove viene richiesta un'illuminazione professionale dal design minimale, come ad esempio UFFICI e spazi COMMERCIALI.

<b>Sorgente</b>	LED COB / SMD
<b>Potenza</b>	5W / 29W
<b>Driver incluso</b>	No
<b>Driver disponibili</b>	On/Off
<b>Lumen</b>	500 / 3900 Lm
<b>MacAdam</b>	3SDC
<b>Angolo</b>	30° / 100°
<b>CCT</b>	3000K / 4000K
<b>CRI</b>	$\geq 80$
<b>UGR</b>	<9 / <13 / <19
<b>Durata LED</b>	50.000h
<b>Classe isolamento</b>	III
<b>IP</b>	20
<b>Materiale</b>	Alluminio
<b>Garanzia</b>	5 anni







# Arca Track

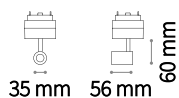

90° 355° Peso 0,20 Kg

## LED SMD HIGH QUALITY\*

Potenza	Angolo	Flux	CCT	Finitura	Codice
5 W	40°	500 Lm	3000 K	Nero	■ 222974
		550 Lm	4000 K	Nero	■ 223056

## OPTIONAL Non incluso



	Angolo	Codice
Lente	20°	223087

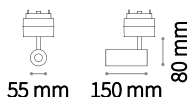

90° 355° Peso 0,46 Kg

## LED COB HIGH QUALITY\* UGR <19

Potenza	Angolo	Flux	CCT	Finitura	Codice
14 W	36°	1400 Lm	3000 K	Nero	■ 222967
		1500 Lm	4000 K	Nero	■ 223049

## OPTIONAL Non incluso



	Angolo	Codice
Lente	18°	223094

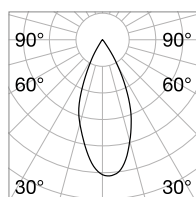

m	lx	øm
1	506	0,77
2	126	1,55
3	56	2,33
4	31	3,11
5	20	3,88

CRI≥80 5W 40° 500 Lm 3000 K

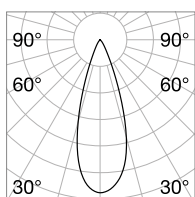

m	lx	øm
1	2336	0,60
2	584	1,21
3	259	1,81
4	146	2,42
5	93	3,02

CRI≥80 14W 36° 1400 Lm 3000 K

\*Per ulteriori informazioni, si prega di contattare l'ufficio tecnico.

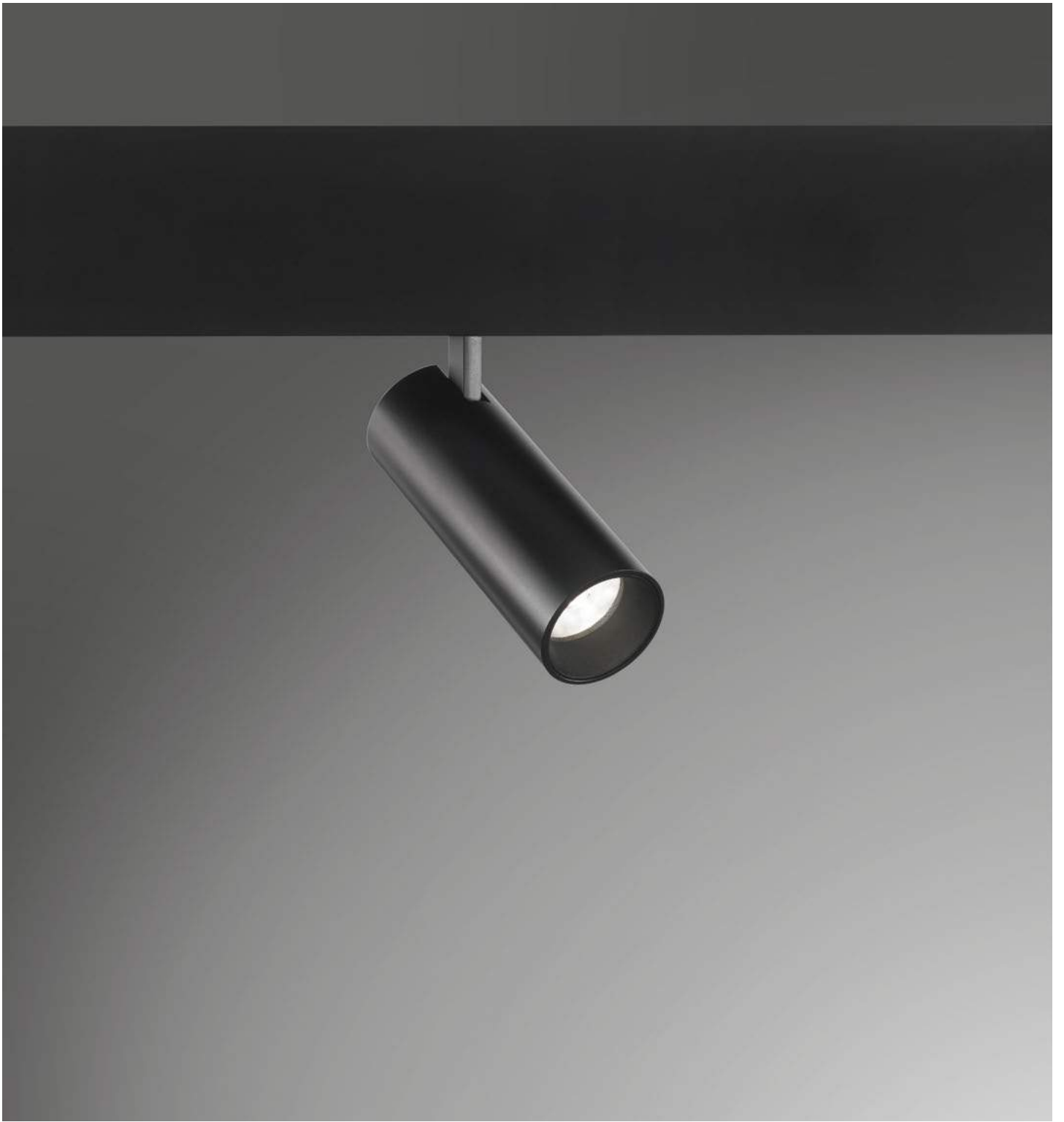



# Arca Accent

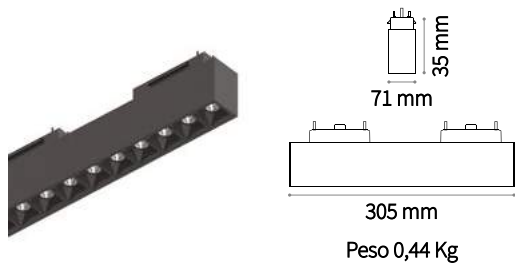

LED SMD HIGH QUALITY\* UGR <13

Potenza	Angolo	Flux	CCT	Finitura	Codice
15 W	40°	1900 Lm	3000 K	Nero	■ 222929
		2000 Lm	4000 K	Nero	■ 223001

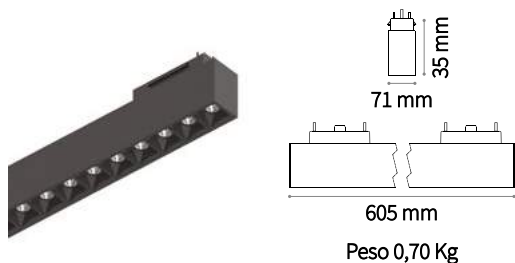

LED SMD HIGH QUALITY\* UGR <13

Potenza	Angolo	Flux	CCT	Finitura	Codice
29 W	40°	3700 Lm	3000 K	Nero	■ 222936
		3900 Lm	4000 K	Nero	■ 223018

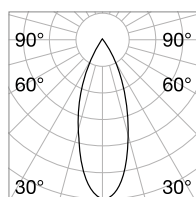

m	lx	ø m
1	2707	0,56
2	676	1,13
3	300	2,26
4	169	2,83
5	108	3,39

CRI ≥ 80 15W 40° 1900 Lm 3000 K

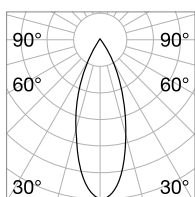

m	lx	ø m
1	4826	0,60
2	1207	1,21
3	536	1,81
4	301	2,42
5	193	3,02

CRI ≥ 80 29W 40° 3700 Lm 3000 K

\*Per ulteriori informazioni, si prega di contattare l'ufficio tecnico.

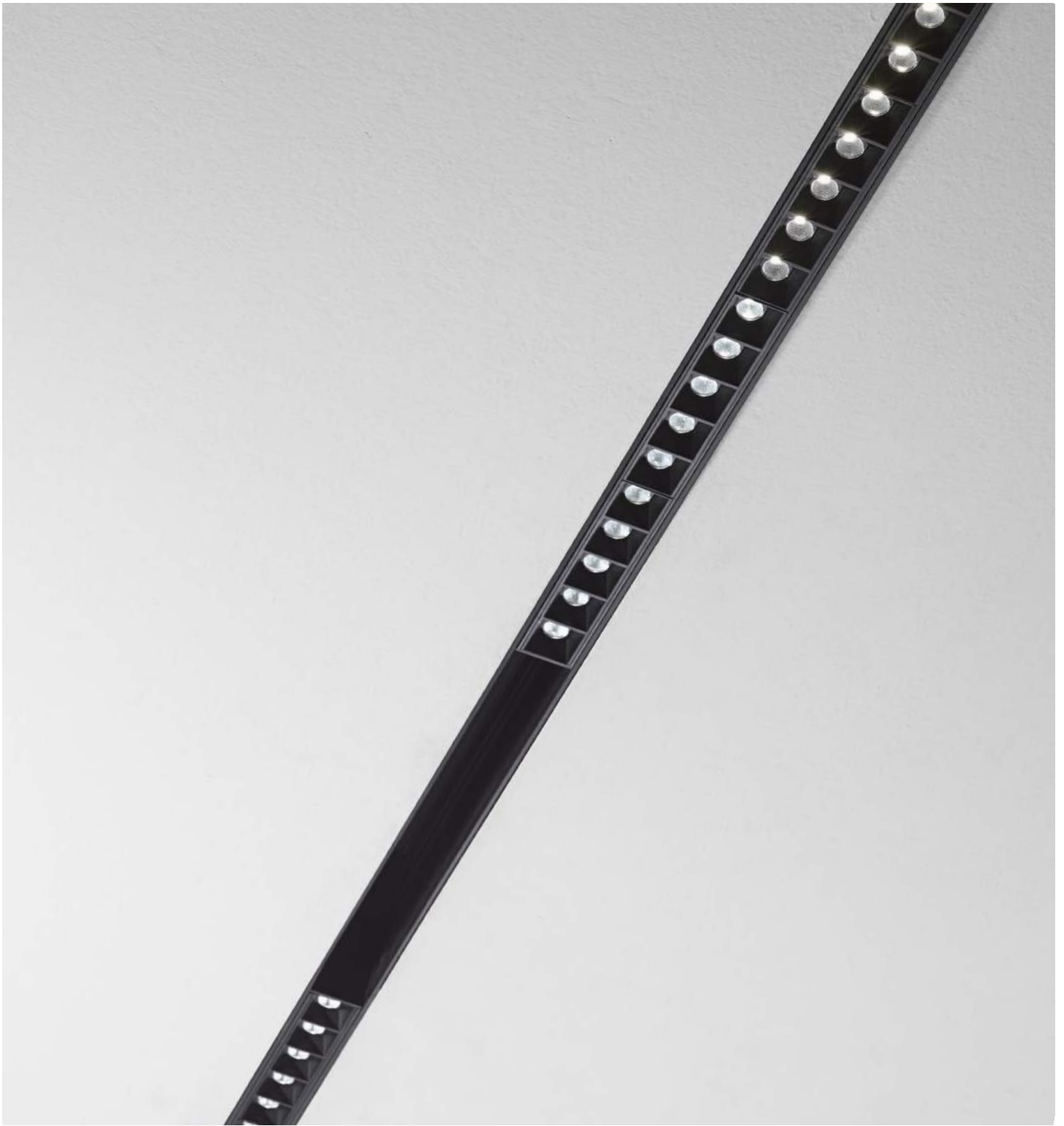

Arca Accent 300 mm



Arca Accent 600 mm



# Arca Wide

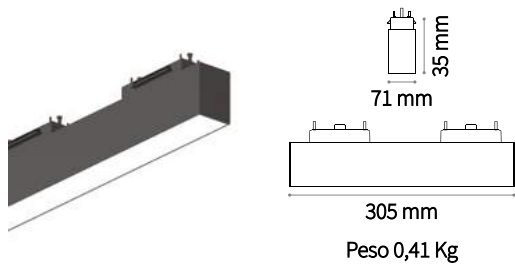

## LED SMD HIGH QUALITY\*

Potenza	Angolo	Flux	CCT	Finitura	Codice
13 W	100°	1500 Lm	3000 K	Nero	■ 222943
		1600 Lm	4000 K	Nero	■ 223025

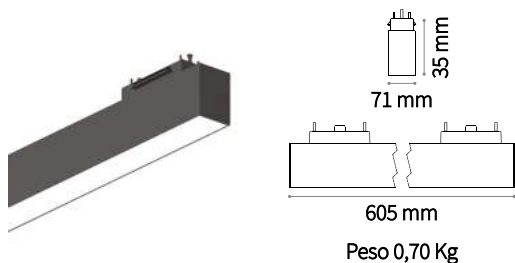

## LED SMD HIGH QUALITY\*

Potenza	Angolo	Flux	CCT	Finitura	Codice
26 W	100°	3300 Lm	3000 K	Nero	■ 222950
		3500 Lm	4000 K	Nero	■ 223032

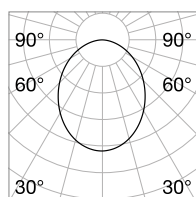

m	lx	ø m
1	203	2,16
2	50	4,33
3	22	6,50
4	12	8,66
5	8	10,83

CRI≥80 13W 100° 1500 Lm 3000 K

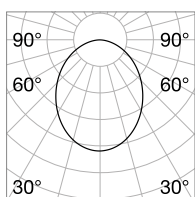

m	lx	ø m
1	440	2,14
2	110	4,28
3	48	6,42
4	27	8,56
5	17	10,70

CRI≥80 26W 100° 3300 Lm 3000 K

\*Per ulteriori informazioni, si prega di contattare l'ufficio tecnico.





Arca Wide 300 mm



Arca Wide 600 mm



# Arca Pendant

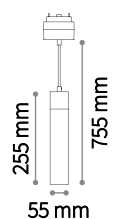

Peso 0,74 Kg

LED COB HIGH QUALITY\* UGR <19

Potenza	Angolo	Flux	CCT	Finitura	Codice	Lunghezza cavi
14 W	36°	1400 Lm	3000 K	Nero	■ 222981	500 mm
		1500 Lm	4000 K	Nero	■ 223063	

OPTIONAL Non incluso



	Angolo	Codice
Lente	18°	223285

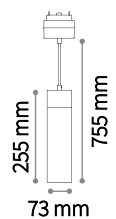

Peso 1,08 Kg

LED COB HIGH QUALITY\* UGR <19

Potenza	Angolo	Flux	CCT	Finitura	Codice	Lunghezza cavi
20 W	30°	2400 Lm	3000 K	Nero	■ 222998	500 mm
		2500 Lm	4000 K	Nero	■ 223070	

OPTIONAL Non incluso



	Angolo	Codice
Lente	15°	223292

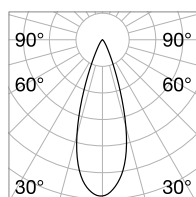

m	lx	ø m
1	203	2,16
2	50	4,33
3	22	6,50
4	12	8,66
5	8	10,83

CRI≥80 14W 36° 1400 Lm 3000 K

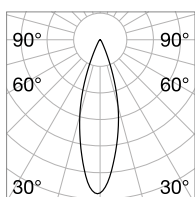

m	lx	ø m
1	4788	0,51
2	1197	1,03
3	532	1,55
4	299	2,06
5	191	2,58

CRI≥80 20W 30° 2400 Lm 3000 K

\*Per ulteriori informazioni, si prega di contattare l'ufficio tecnico.





# Arca - Pendant

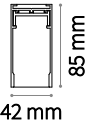

Peso 1,34 Kg

## TRACK 1000 mm

Finitura	Codice
Nero	222745

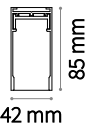

Peso 4,02 Kg

## TRACK 3000 mm

Finitura	Codice
Nero	222752



## MOUNTING KIT Non incluso/Necessario - 1 kit x 2000 mm

	Rosone	N° Cavi	Finitura	Codice	Lunghezza cavi
Kit Sospensione	No	2	Grigio	222905	2000 mm



## END CAP Non incluso/Necessario

Codice
223148



## ELECTRIFIED END CAP Non incluso/Necessario

Codice	Lunghezza cavi
223131	1780 mm

# Arca - Surface

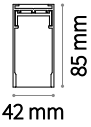

Peso 1,34 Kg

## TRACK 1000 mm

Finitura	Codice
Nero	222745

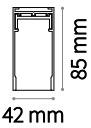

Peso 4,02 Kg

## TRACK 3000 mm

Finitura	Codice
Nero	222752



## MOUNTING KIT Non incluso/Necessario - 1 kit x 1000 mm

	Finitura	Codice
Kit Soffitto	Grigio	222899



## END CAP Non incluso/Necessario

Codice
223148



## ELECTRIFIED END CAP Non incluso/Necessario

Codice
223124

# Arca - Recessed

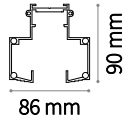

Peso 2,90 Kg

**TRACK 1000 mm** Kit per montaggio profilo incluso

Finitura	Codice
Nero	■ 222769

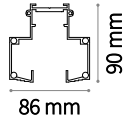

Peso 8,70 Kg

**TRACK 3000 mm** Kit per montaggio profilo incluso

Finitura	Codice
Nero	■ 222882



**END CAP** Non incluso/Necessario

Codice
223148



**ELECTRIFIED END CAP** Non incluso/Necessario

Codice
223124



Incasso

Soffitto

Sospensione



# Arca - Optional



**BLINDED COVER** Non incluso/Optional

Materiale	Lunghezza	Colore	Codice
PC	990 mm	Nero	■ 222912



**STRUCTURE CONNECTOR** Non incluso/Optional

Codice  
**223100**



**ELECTRIFIED CONNECTOR** Non incluso/Optional

Codice  
**223117**



**DRIVER ON/OFF** Non incluso/Necessario

Potenza	Output	Corrente	Misura	Codice
60 W	48 V	1300 mA	171x62x37	<b>223155</b>
90 W	48 V	2000 mA	220x68x37	<b>223162</b>
150 W	48 V	3200 mA	228x68x37	<b>223179</b>

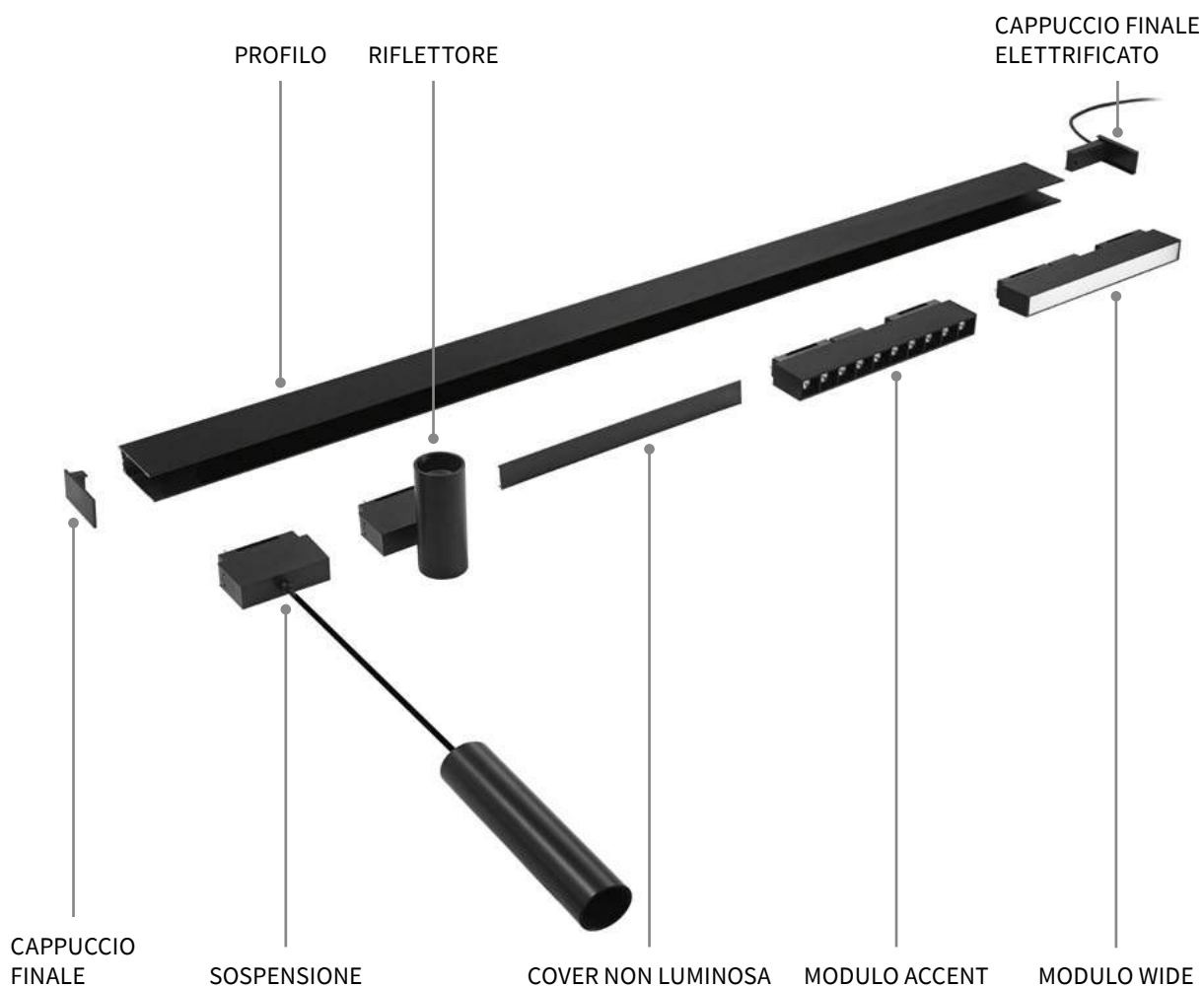

# Oxy

Profilo in alluminio estruso compatibile con elementi di illuminazione a fissaggio magnetico e blocco meccanico di sicurezza. Il sistema è verniciato a polveri e disponibile in colore nero nella modalità d'installazione a plafone. I moduli sono componibili a seconda della disposizione desiderata. La sezione del profilo è larga 26 mm e alta 27 mm o 52 mm; disponibile in due lunghezze, 2000 mm e 3000 mm.

Possibilità di assemblaggio con diversi moduli sorgente: il modulo WIDE diffondente; il modulo ACCENT con controllo dell'UGR inferiore a 19; il modulo TRACK SINGLE oppure DOUBLE per un'illuminazione spot con differenti angoli di emissione e il modulo decorativo PENDANT TUBE. LED integrati, temperatura di colore di 3000 K; Binning iniziale  $\leq 2$ -Step MacAdam; min. 80% di flusso luminoso rimanente dopo 35.000 h di durata; protezione IP20, classe isolamento III. L'alimentazione in 48V conferisce grande versatilità e sicurezza, le composizioni sono infatti reversibili e modificabili all'occorrenza. Ideale per l'illuminazione di grandi ambienti dove viene richiesta ampia flessibilità e resa cromatica, ad esempio spazi MUSEALI, COMMERCIALI, RESIDENZIALI e RETAIL.

<b>Sorgente</b>	LED COB / SMD
<b>Potenza</b>	3,5W / 26W
<b>Driver incluso</b>	No
<b>Driver disponibili</b>	On/Off
<b>Lumen</b>	200 / 1800 Lm
<b>MacAdam</b>	2SDC
<b>Angolo</b>	23° / 115°
<b>CCT</b>	2700K / 3000K
<b>CRI</b>	$\geq 90$
<b>UGR</b>	<19
<b>Durata LED</b>	35.000h
<b>Classe isolamento</b>	III
<b>IP</b>	20
<b>Materiale</b>	Alluminio
<b>Garanzia</b>	3 anni







# Oxy Track Single

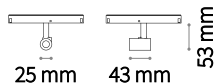

LED COB HIGH QUALITY\*

Potenza	Angolo	Flux	CCT	Finitura	Codice
3,5 W	23°	200 Lm	3000 K	Nero	■ 224107



90° 355° Peso 0,10 Kg

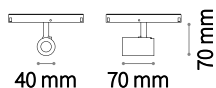

LED COB HIGH QUALITY\*

Potenza	Angolo	Flux	CCT	Finitura	Codice
8 W	36°	600 Lm	3000 K	Nero	■ 224138



90° 355° Peso 0,17 Kg

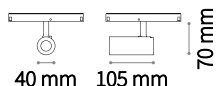

LED COB HIGH QUALITY\*

Potenza	Angolo	Flux	CCT	Finitura	Codice
12 W	34°	800 Lm	3000 K	Nero	■ 224169



90° 355° Peso 0,21 Kg

OPTIONAL Non incluso



	Angolo	Codice
Lente 3,5 W	12°	224121
Lente 8 W	20°	224183
Lente 12 W	20°	224183

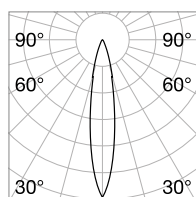

m	lx	øm
1	576	0,39
2	144	0,78
3	64	1,17
4	36	1,56
5	23	1,96

CRI≥90 3,5W 23° 200 Lm 3000 K

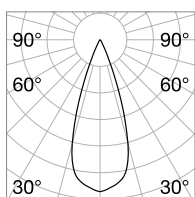

m	lx	øm
1	1149	0,60
2	287	1,20
3	127	1,80
4	71	2,40
5	46	3,00

CRI≥90 8W 36° 600 Lm 3000 K

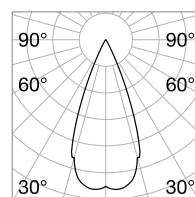

m	lx	øm
1	1842	0,60
2	460	1,21
3	204	1,81
4	115	2,42
5	73	3,02

CRI≥90 12W 34° 800 Lm 3000 K

\*Per ulteriori informazioni, si prega di contattare l'ufficio tecnico.

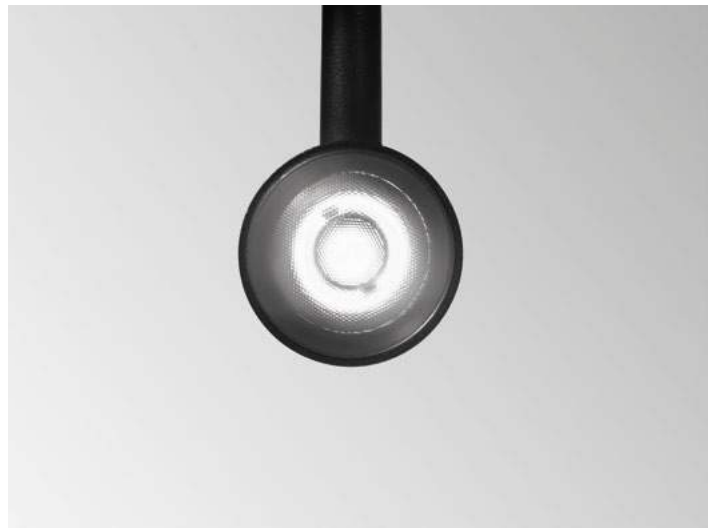
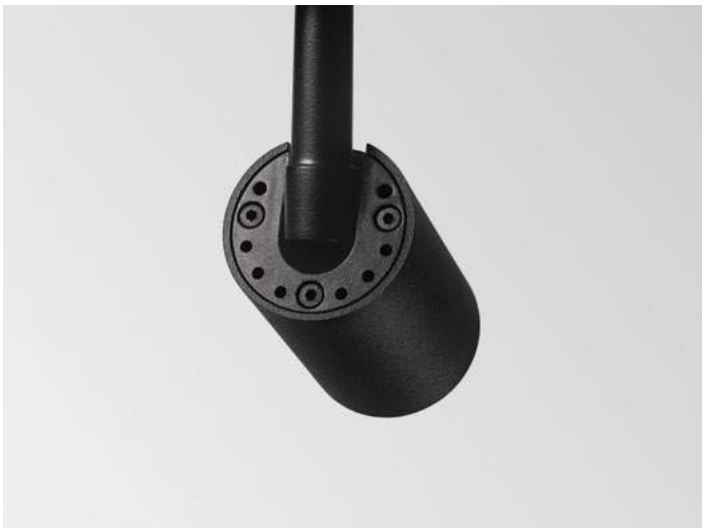

# Oxy Track Double

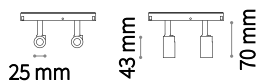

LED COB HIGH QUALITY\*

Potenza	Angolo	Flux	CCT	Finitura	Codice
5 W	23°	380 Lm	3000 K	Nero	■ 224114



90° 355° Peso 0,16 Kg

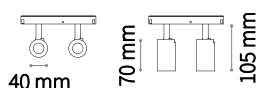

LED COB HIGH QUALITY\*

Potenza	Angolo	Flux	CCT	Finitura	Codice
15 W	36°	1100 Lm	3000 K	Nero	■ 224145



90° 355° Peso 0,31 Kg

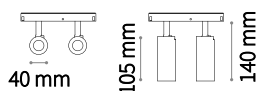

LED COB HIGH QUALITY\*

Potenza	Angolo	Flux	CCT	Finitura	Codice
22 W	34°	1700 Lm	3000 K	Nero	■ 224176



90° 355° Peso 0,38 Kg

OPTIONAL Non incluso



	Angolo	Codice
Lente 5 W	12°	224121
Lente 15 W	20°	224183
Lente 22 W	20°	224183

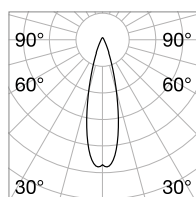

m	lx	øm
1	1081	0,40
2	270	0,80
3	120	1,20
4	67	1,60
5	43	2,01

CRI≥90 5W 23° 380 Lm 3000 K

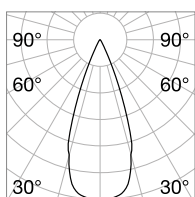

m	lx	øm
1	1989	0,64
2	497	1,28
3	221	1,92
4	124	2,56
5	79	3,20

CRI≥90 15W 36° 1100 Lm 3000 K

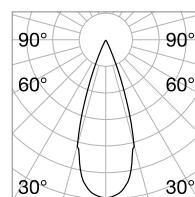

m	lx	øm
1	2043	0,62
2	510	1,24
3	227	1,86
4	127	2,48
5	81	3,10

CRI≥90 22W 34° 1700 Lm 3000 K

\*Per ulteriori informazioni, si prega di contattare l'ufficio tecnico.



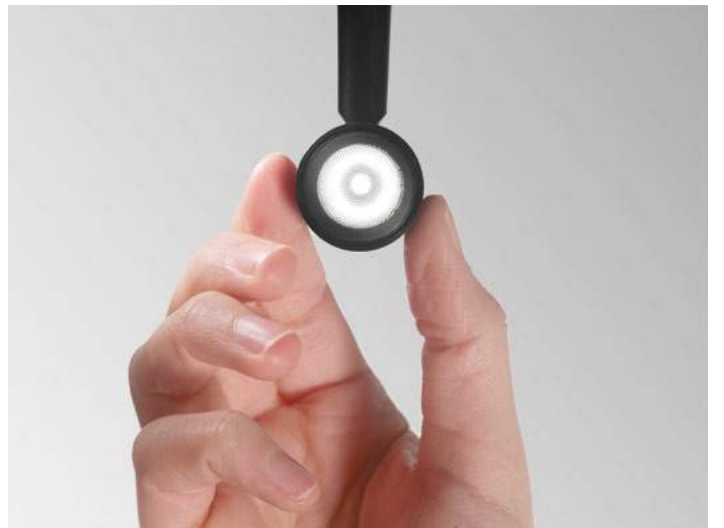

# Oxy Accent and Wide

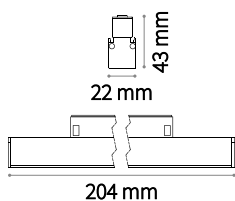

Peso 0,16 Kg

## LED COB HIGH QUALITY\*

Potenza	Angolo	Flux	CCT	Finitura	Codice
8 W	32°	730 Lm	2700 K	Nero	■ 224084

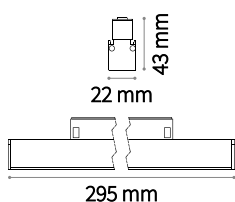

Peso 0,22 Kg

## LED COB HIGH QUALITY\*

Potenza	Angolo	Flux	CCT	Finitura	Codice
15 W	32°	1200 Lm	2700 K	Nero	■ 224091

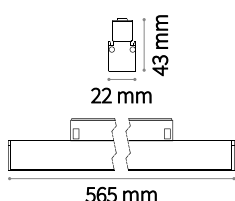

Peso 0,31 Kg

## LED SMD HIGH QUALITY\*

Potenza	Angolo	Flux	CCT	Finitura	Codice
13 W	115°	900 Lm	3000 K	Nero	■ 224053

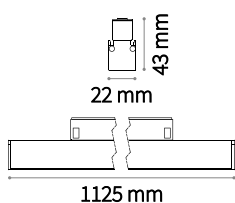

Peso 0,62 Kg

## LED SMD HIGH QUALITY\*

Potenza	Angolo	Flux	CCT	Finitura	Codice
26 W	115°	1800 Lm	3000 K	Nero	■ 224060

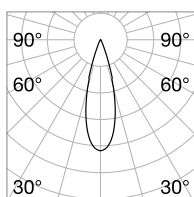

m	lx	ø m
1	3640	0,49
2	910	0,99
3	404	1,48
4	227	1,98
5	145	2,47

CRI≥90 15W 32° 1200 Lm 2700 K

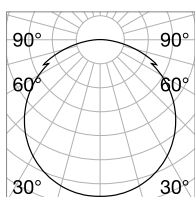

m	lx	ø m
1	165	2,99
2	41	5,99
3	18	8,98
4	10	11,98
5	6	14,97

CRI≥90 26W 115° 1800 Lm 3000 K

\*Per ulteriori informazioni, si prega di contattare l'ufficio tecnico.





# Oxy Pendant

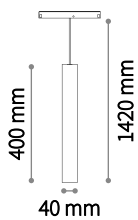

Peso 0,65 Kg

## LED COB HIGH QUALITY\*

Potenza	Angolo	Flux	CCT	Finitura	Codice
8,2 W	36°	520 Lm	3000 K	Nero	■ 224190

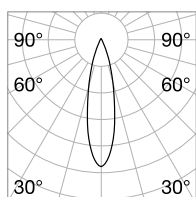

m	lx	øm
1	1257	0,41
2	314	0,82
3	139	1,24
4	78	1,65
5	50	2,07

CRI≥90 8W 36° 520 Lm 3000 K

\*Per ulteriori informazioni, si prega di contattare l'ufficio tecnico.



# Oxy - Track



Peso 1,52 Kg

## TRACK 2000 mm

Finitura	Codice
Nero	224725



Peso 2,25 Kg

## TRACK 3000 mm

Finitura	Codice
Nero	224732



## END CAP Non incluso/Necessario

	Codice
Senza foro	224756
Con foro	224763

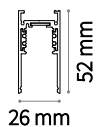

Peso 1,97 Kg

## TRACK 2000 mm

Finitura	Codice
Nero	223988

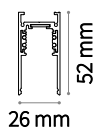

Peso 2,90 Kg

## TRACK 3000 mm

Finitura	Codice
Nero	223995



## END CAP Non incluso/Necessario

	Codice
Senza foro	224213
Con foro	224718



# Oxy - Optional



**MOUNTING KIT** Non incluso/Optional - 2 kit x 1000 mm

	Rosone	N° Cavi	Finitura	Codice	Lunghezza cavi
Kit Sospensione	No	1	Grigio	224022	5000 mm



**ENERGY SUPPLY** Non incluso/Optional

Codice

224237



**ELECTRIFIED CONNECTOR** Non incluso/Optional

Codice

224244



**STRUCTURE CONNECTOR** Non incluso/Optional

Codice

224282



**DRIVER ON/OFF** Non incluso/Necessario

Potenza	Output	Corrente	Misura	Codice
60 W	48 V	1250 mA	162,5x42,5x32	224251
150 W	48 V	3200 mA	191x63x37,5	224268
240 W	48 V	5000 mA	244x68x39	224275

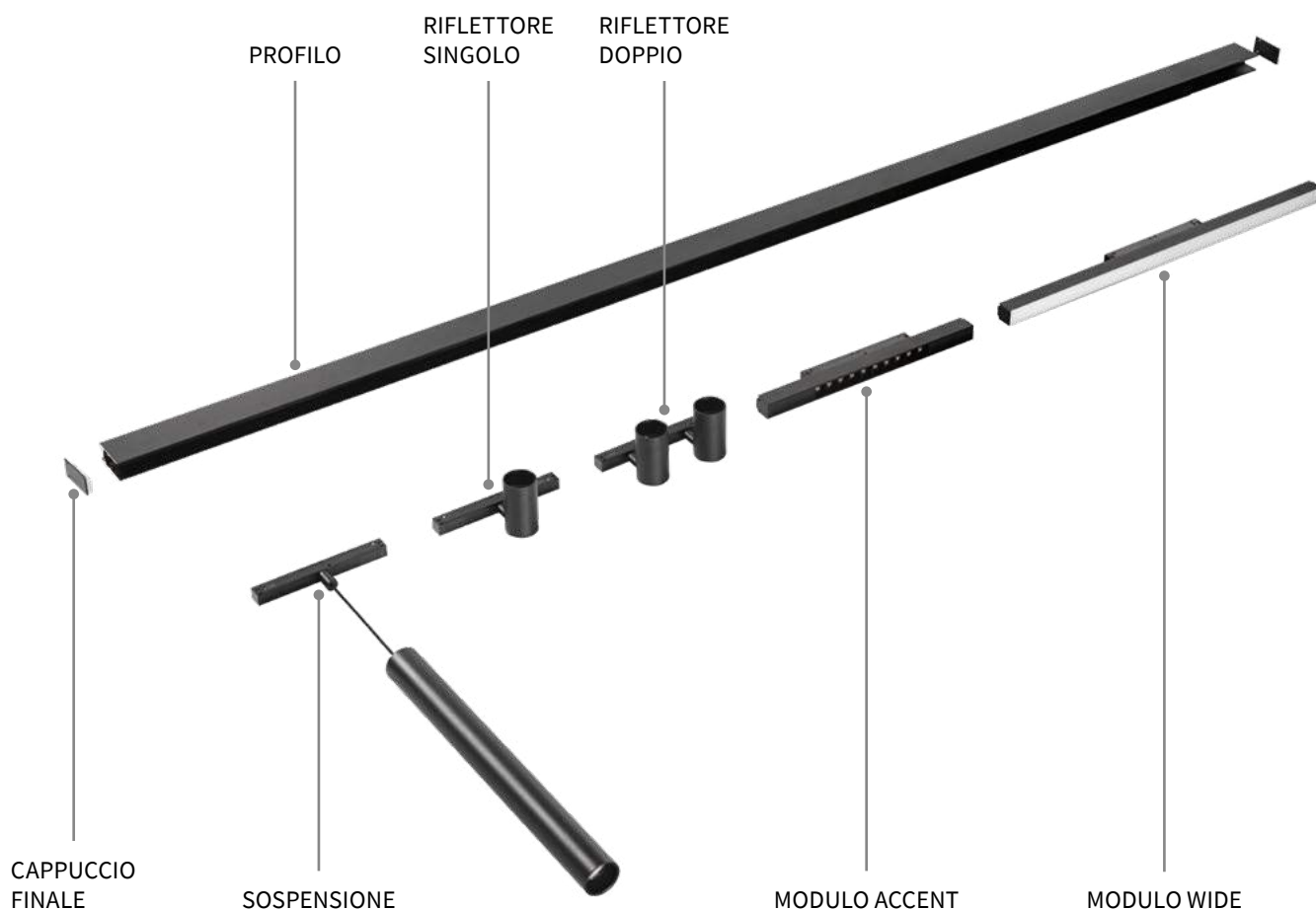

# Fluo

Sistema lineare di lampade con scocca in alluminio estruso di sezione larga 50 mm e alta 80 mm. Moduli disponibili in due lunghezze: 1200 mm e 1800 mm, componibili tra loro a seconda della disposizione desiderata. Possibilità di assemblaggio di tre diversi moduli sorgente: il modulo WIDE diffondente, il modulo BI-EMISSION con componente di luce per l'illuminazione indiretta e il modulo ACCENT con controllo dell'UGR inferiore a 19; LED integrati, possibilità di temperatura di colore di 3000 K o di 4000 K; binning iniziale  $\leq 3$ -Step MacAdam; min. 80% di flusso luminoso rimanente dopo 30000 h di durata; protezione IP 20, classe isolamento I. Il sistema è disponibile nei colori alluminio anodizzato, bianco, nero e nelle possibili modalità d'installazione a plafone, a sospensione oppure a incasso a filo in soffitti di cartongesso. Driver incluso, integrato nel corpo illuminante, disponibile in versione dimmerabile sia DALI che 1-10V. Sistema adatto per ambienti dove richiesta un'illuminazione professionale dal design minimale, ad esempio UFFICI e spazi COMMERCIALI.

<b>Sorgente</b>	LED COB / SMD
<b>Potenza</b>	26W / 36+18W
<b>Driver incluso</b>	On/Off
<b>Driver disponibili</b>	1-10V / DALI
<b>Lumen</b>	2200 / 4000+2800 Lm
<b>MacAdam</b>	3SDC
<b>Angolo</b>	Accent / Wide / Bi-Emission
<b>CCT</b>	3000 K / 4000 K
<b>CRI</b>	$\geq 83$
<b>UGR</b>	<19 (Accent)
<b>Durata LED</b>	30.000 h
<b>Classe isolamento</b>	I
<b>IP</b>	20
<b>Materiale</b>	Alluminio
<b>Garanzia</b>	5 anni



Incasso

Soffitto

Sospensione







# Fluo Accent

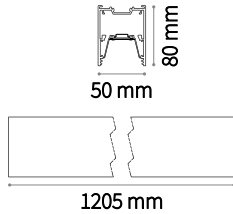

Peso 2,76 Kg

**LED COB AND DRIVER HIGH QUALITY\*** Driver ON/OFF incluso - UGR <19

Potenza	Angolo	Flux	CCT	Finitura	Codice
30 W	30°	2200 Lm	3000 K	Alluminio	192635
				Bianco	192611
				Nero	192581
2400 Lm	4000 K			Alluminio	192574
				Bianco	192543
				Nero	192529

**DIMMABLE DRIVER** Non incluso/Optional

	Potenza	Output	Corrente	Misura	Codice
1-10V	39 W	27/56Vdc	700 mA	280x30x21 mm	216416
DALI	38 W	20/54Vdc	700 mA	280x30x21 mm	216270

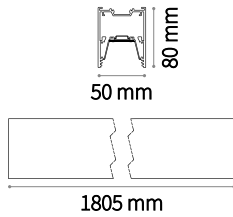

Peso 3,86 Kg

**LED COB AND DRIVER HIGH QUALITY\*** Driver ON/OFF incluso - UGR <19

Potenza	Angolo	Flux	CCT	Finitura	Codice
30 W	30°	2200 Lm	3000 K	Alluminio	192512
				Bianco	192499
				Nero	192475
2400 Lm	4000 K			Alluminio	192451
				Bianco	192444
				Nero	192420

**DIMMABLE DRIVER** Non incluso/Optional

	Potenza	Output	Corrente	Misura	Codice
1-10V	39 W	27/56Vdc	700 mA	280x30x21 mm	216416
DALI	38 W	20/54Vdc	700 mA	280x30x21 mm	216270

**MOUNTING KIT** Non incluso/Necessario - Pagina 735

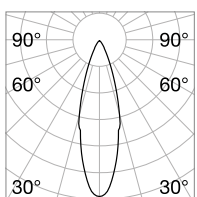

m	lx	øm
1	8264	0,48
2	2066	0,96
3	918	1,45
4	516	1,93
5	330	2,42

CRI≥83 30W 30° 2200 Lm 3000 K

\*Per ulteriori informazioni, si prega di contattare l'ufficio tecnico.



Fluo Accent 1200

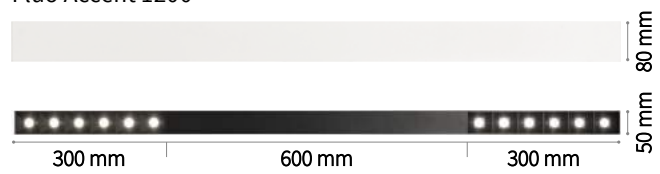

Fluo Accent 1800

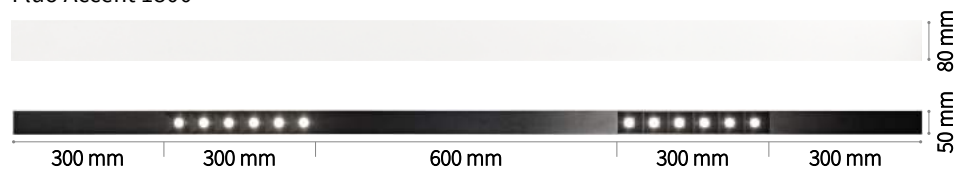

Lo spessore del singolo cappuccio finale è di 2,5 mm.

# Fluo Wide

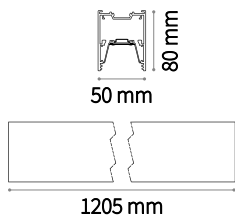

Peso 2,89 Kg

**LED SMD AND DRIVER HIGH QUALITY\*** Driver ON/OFF incluso

Potenza	Angolo	Flux	CCT	Finitura	Codice
26 W	105°	2800 Lm	3000 K	Alluminio	191447
				Bianco	192437
				Nero	191997
3000 Lm	4000 K			Alluminio	192468
				Bianco	192482
				Nero	192505

**DIMMABLE DRIVER** Non incluso/Optional

	Potenza	Output	Corrente	Misura	Codice
1-10V	28 W	27/56Vdc	500 mA	280x30x21 mm	216423
DALI	27 W	20/54Vdc	500 mA	280x30x21 mm	216287

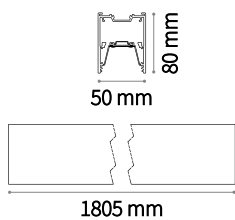

Peso 4,42 Kg

**LED SMD AND DRIVER HIGH QUALITY\*** Driver ON/OFF incluso

Potenza	Angolo	Flux	CCT	Finitura	Codice
36 W	105°	3800 Lm	3000 K	Alluminio	192536
				Bianco	192550
				Nero	192567
4000 Lm	4000 K			Alluminio	192598
				Bianco	192604
				Nero	192628

**DIMMABLE DRIVER** Non incluso/Optional

	Potenza	Output	Corrente	Misura	Codice
1-10V	39 W	27/56Vdc	700 mA	280x30x21 mm	216416
DALI	38 W	20/54Vdc	700 mA	280x30x21 mm	216270

**MOUNTING KIT** Non incluso/Necessario - Pagina 735

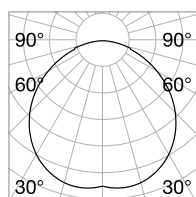

m	lx	Øm
1	1042	2,50
2	260	5,00
3	115	7,50
4	65	10,00
5	41	12,50

CRI≥83 26W 105° 2800 Lm 3000 K

\*Per ulteriori informazioni, si prega di contattare l'ufficio tecnico.





Fluo Wide 1200

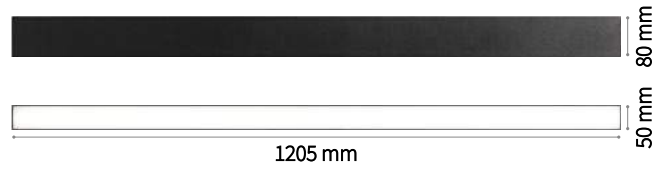

Fluo Wide 1800

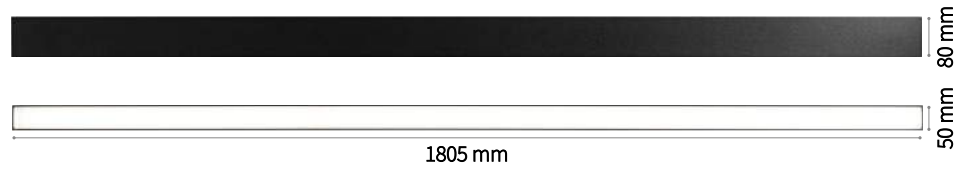

Lo spessore del singolo cappuccio finale è di 2,5 mm.

# Fluo Bi-Emission

LUCE INDIRECTA INCLUSA (•)

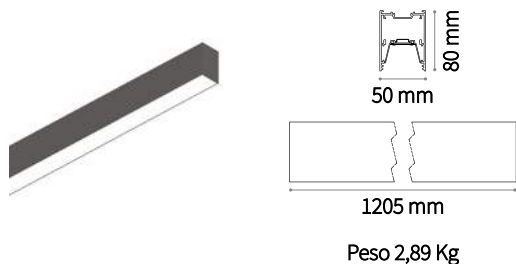

LED SMD AND DRIVER HIGH QUALITY\* Driver ON/OFF incluso

Potenza	Angolo	Flux	CCT	Finitura	Codice
26 W	105°	2800 Lm	3000 K	Alluminio	192659
13 W •	105° •	1900 Lm •		Bianco	192666
				Nero	192710
		3000 Lm	4000 K	Alluminio	192734
		2100 Lm •		Bianco	192741
				Nero	192758

DIMMABLE DRIVER Non incluso/Optional

	Potenza	Output	Corrente	Misura	Codice
1-10V	17 W	27/56Vdc	300 mA	280x30x21 mm	216447
DALI	14 W	20/54Vdc	250 mA	280x30x21 mm	216300

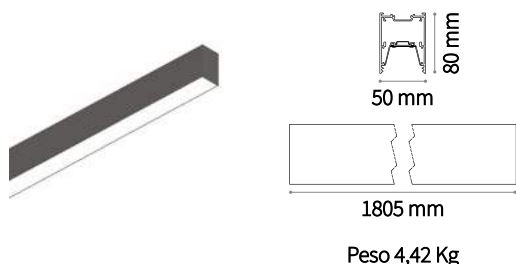

LED SMD AND DRIVER HIGH QUALITY\* Driver ON/OFF incluso

Potenza	Angolo	Flux	CCT	Finitura	Codice
36 W	105°	3800 Lm	3000 K	Alluminio	192727
18 W •	105° •	2600 Lm •		Bianco	192703
				Nero	192697
		4000 Lm	4000 K	Alluminio	192680
		2800 Lm •		Bianco	192673
				Nero	192642

DIMMABLE DRIVER Non incluso/Optional

	Potenza	Output	Corrente	Misura	Codice
1-10V	20 W	27/56Vdc	350 mA	280x30x21 mm	216430
DALI	19 W	20/54Vdc	350 mA	280x30x21 mm	216294

MOUNTING KIT Non incluso/Necessario - Pagina 735

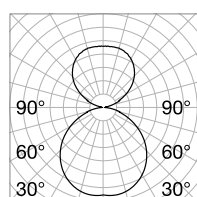

m	lx	øm
1	512	2,10
2	128	4,21
3	56	6,32
4	32	8,43
5	20	10,54

CRI≥83 26+13W 105°+105° 2800+1900 Lm 3000 K

\*Accensione separata. Per ulteriori informazioni, si prega di contattare l'ufficio tecnico.



Fluo Bi-Emission 1200

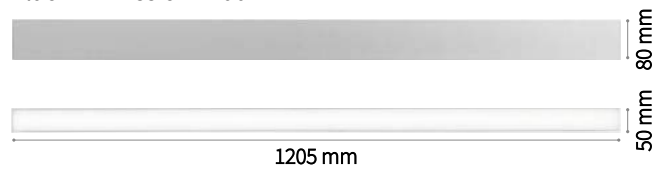

Fluo Bi-Emission 1800

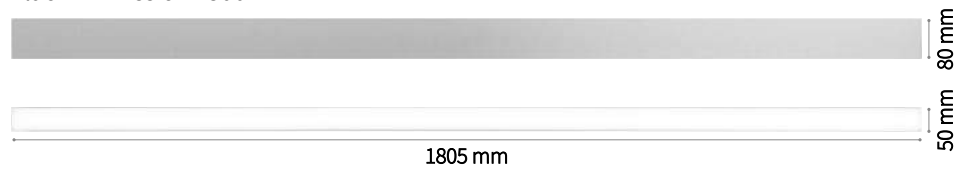

Lo spessore del singolo cappuccio finale è di 2,5 mm.



# Fluo - Optional

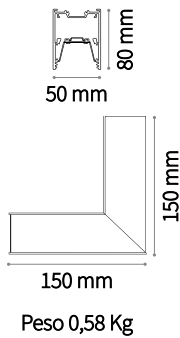

## CORNER Non incluso/Optional

Potenza	Angolo	Flux	CCT	Finitura	Codice
8 W	105°	750 Lm	3000 K	Alluminio	191416
				Bianco	191423
				Nero	191430
800 Lm	4000 K		Alluminio	191980	
			Bianco	191454	
			Nero	191461	

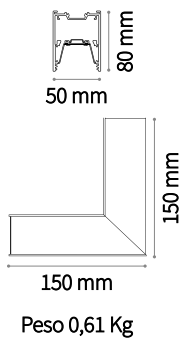

## BLINDED CORNER Non incluso/Optional

Finitura	Codice
Alluminio	191478
Bianco	191485
Nero	191492

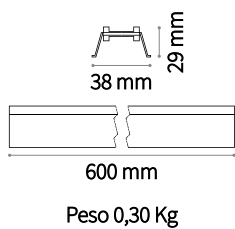

## STRIP LED MODULE Accessori per personalizzazione

Potenza	Angolo	Flux	CCT	Voltaggio	Codice
8 W	105°	900 Lm	3000 K	12V	198668
		950 Lm	4000 K	12V	198675
13W	105°	1300 Lm	3000 K	24 V	198699
			3000 K	48 V	198705
		1400 Lm	4000 K	24 V	198682
			4000 K	48 V	198712

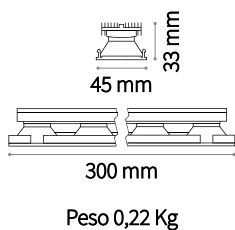

## ACCENT MODULE Accessori per personalizzazione

Potenza	Angolo	Flux	CCT	Finitura	Codice
13 W	30°	1100 Lm	3000 K	Nero	199023
		1200 Lm	4000 K	Nero	199030

# Fluo - Kit and Optional

**MOUNTING KIT** Non incluso/Necessario - 1 kit x 1500 mm



	Rosone	N° Cavi	Finitura	Codice	Lunghezza cavi
Kit Sospensione	Sì	2	Bianco	191591	2000 mm
		2	Nero	191164	
	Sì	2	Bianco	215907	5000 mm
		2	Nero	215891	
No	1		220826	2000 mm	



	Finitura	Codice
Kit Incasso	Grigio	191188



	Finitura	Codice
Kit Soffitto	Grigio	191171

**COVER** Non incluso/Optional



	Materiale	Lunghezza	Colore	Codice
Opale	PMMA	600 mm	Bianco	191645
		1200 mm	Bianco	191652
		1800 mm	Bianco	191669
Non luminosa	Alluminio	150 mm	Nero	191355
		300 mm	Nero	191362
		600 mm	Nero	191379

**STRUCTURE CONNECTOR** Non incluso/Optional



Codice  
**191508**

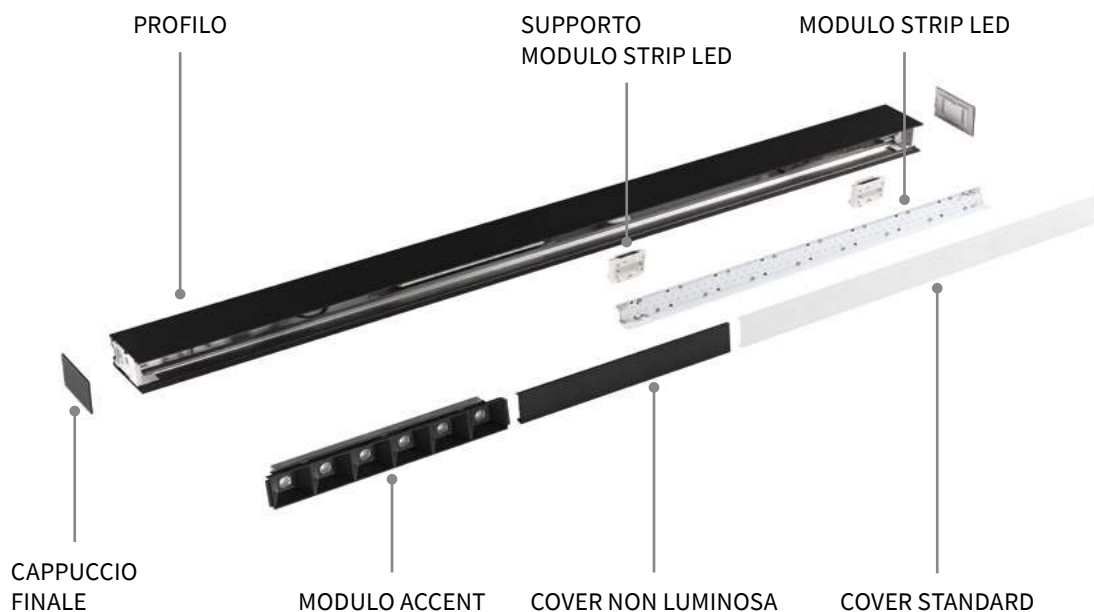

# Draft

LUCE INDIRECTA INCLUSA (●)

<b>Sorgente</b>	LED SMD	<b>CCT</b>	3000 K / 4000 K
<b>Potenza</b>	25 + 25 W	<b>CRI</b>	≥80
<b>Driver incluso</b>	On/Off / 1-10V	<b>UGR</b>	<19
<b>Driver disponibili</b>	No	<b>Durata LED</b>	50.000 h
<b>Kit emergency</b>	Disponibile	<b>Classe isolamento</b>	I
<b>Lumen</b>	2800 / 3100 Lm	<b>IP</b>	20
<b>MacAdam</b>	3SDC	<b>Materiale</b>	Alluminio
<b>Angolo</b>	50°+110°	<b>Garanzia</b>	5 anni

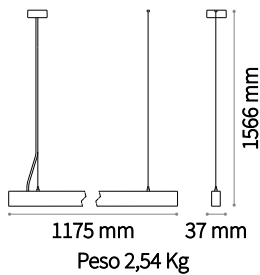

### LED SMD AND DRIVER HIGH QUALITY\* Driver ON/OFF incluso

Potenza	Angolo	Flux	CCT	Finitura	Codice
25 W	50°	2800 Lm	3000 K	Bianco	223780
25 W ●	110° ●	3000 Lm ●		Nero	223773
		3000 Lm	4000 K	Bianco	223803
		3100 Lm ●		Nero	223797

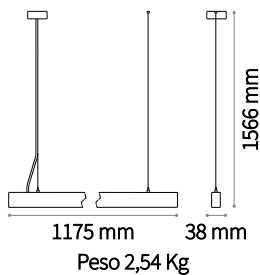

### LED SMD AND DRIVER HIGH QUALITY\* Driver 1-10V incluso

Potenza	Angolo	Flux	CCT	Finitura	Codice
25 W	50°	2800 Lm	3000 K	Bianco	215440
25 W ●	110° ●	3000 Lm ●		Nero	222776
		3000 Lm	4000 K	Bianco	222790
		3100 Lm ●		Nero	222783



### STRUCTURE CONNECTOR Non incluso/Optional

Codice  
**222813**

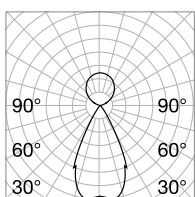

m	lx	øm
1	1999	1,00
2	499	2,01
3	222	3,02
4	124	4,03
5	79	5,04

CRI≥80 25+25W 50°+110° 2800+3000 Lm 3000 K

\*Accensione separata. Per ulteriori informazioni, si prega di contattare l'ufficio tecnico.



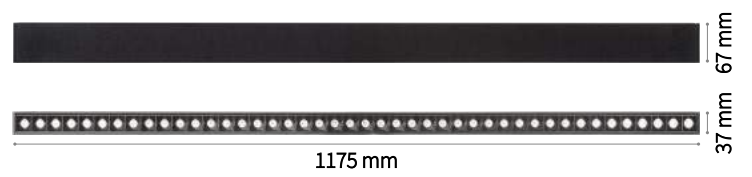

Lo spessore del singolo cappuccio finale è di 2,5 mm.

# Quick

Proiettore cilindrico in alluminio estruso adatto per installazione su binario trifase. Verniciatura a polveri bianco o nero, testata girevole 355° e orientabile 90°. Il driver di alimentazione incluso, trova alloggiamento nel corpo cilindrico del proiettore stesso.

Sorgente luminosa con tecnologia COB LED integrato per la massima efficienza, disponibile con temperatura di colore di 3000 K o 4000 K; LED efficienza energetica elevata resa cromatica fino a CRI  $\geq 90$ ; binning iniziale  $\leq 3$ -Step MacAdam; min. 80% di flusso luminoso rimanente dopo 50.000 h di durata; ottica a fascio simmetrico con tre diversi angoli di emissione e controllo dell'abbagliamento (UGR  $< 19$ ). Montaggio e smontaggio senza utensili. Protezione IP20; classe isolamento I. Ideale per l'illuminazione di grandi ambienti dove viene richiesta ampia flessibilità e resa cromatica, ad esempio spazi MUSEALI, COMMERCIALI e RETAIL.

<b>Sorgente</b>	LED COB
<b>Potenza</b>	15W / 28W
<b>Driver incluso</b>	On/Off
<b>Driver disponibili</b>	No
<b>Circuito</b>	3+Off
<b>Lumen</b>	1500 / 4000 Lm
<b>MacAdam</b>	3SDC
<b>Angolo</b>	30°
<b>CCT</b>	3000 K / 4000 K
<b>CRI</b>	$\geq 80$ / $\geq 90$
<b>UGR</b>	$< 9$ / $< 19$
<b>Durata LED</b>	50.000h
<b>Classe isolamento</b>	I
<b>IP</b>	20
<b>Materiale</b>	Alluminio
<b>Garanzia</b>	5 anni



Link Trimless  
Pag. 754



Link Trim  
Pag. 756

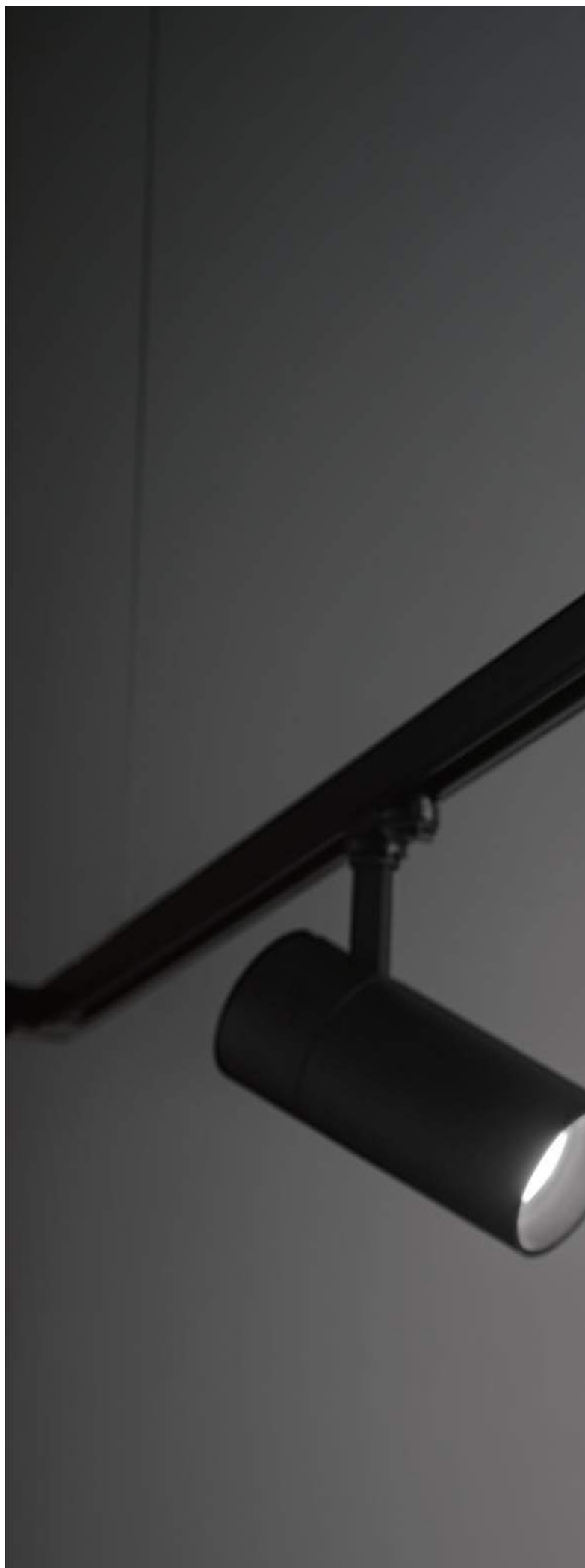





# Quick 15W

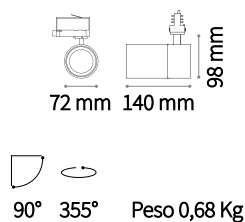

LED COB AND DRIVER HIGH QUALITY\* Driver ON/OFF incluso - UGR <19

CRI ≥80

Potenza	Angolo	Flux	CCT	Finitura	Codice
15 W	30°	1700 Lm	3000 K	Bianco	222509
				Nero	222523
		1800 Lm	4000 K	Bianco	222530
				Nero	222547

CRI ≥90

Potenza	Angolo	Flux	CCT	Finitura	Codice
15 W	30°	1500 Lm	3000 K	Bianco	222554
				Nero	222561
		1600 Lm	4000 K	Bianco	222578
				Nero	222585

OPTIONAL Non incluso



Finitura	Codice
Filtro Honeycomb	222608



Angolo	Codice
Lente 15°	222592

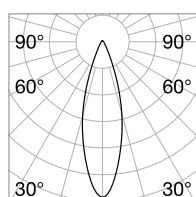

m	lx	øm
1	3451	0,51
2	862	1,02
3	383	1,53
4	215	2,04
5	138	2,55

CRI≥80 15W 30° 1700 Lm 3000 K

\*Per ulteriori informazioni, si prega di contattare l'ufficio tecnico.



# Quick 28W

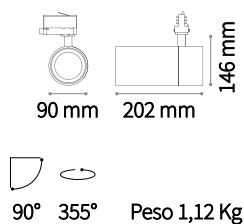

LED COB AND DRIVER HIGH QUALITY\* Driver ON/OFF incluso - UGR <9

CRI ≥80

Potenza	Angolo	Flux	CCT	Finitura	Codice
28 W	30°	3700 Lm	3000 K	Bianco	222615
				Nero	222622
		4000 Lm	4000 K	Bianco	222639
				Nero	222646

CRI ≥90

Potenza	Angolo	Flux	CCT	Finitura	Codice
28 W	30°	3400 Lm	3000 K	Bianco	222653
				Nero	222660
		3600 Lm	4000 K	Bianco	222677
				Nero	222684

OPTIONAL Non incluso



Filtro	Finitura	Codice
	Honeycomb	222714

Lente	Angolo	Codice
	18°	222691
	45°	222707

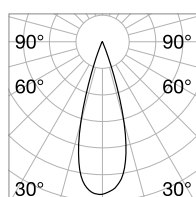

m	lx	øm
1	8760	0,55
2	2190	1,11
3	973	1,67
4	547	2,22
5	350	2,78

CRI≥80 28W 30° 3700 Lm 3000 K

\*Per ulteriori informazioni, si prega di contattare l'ufficio tecnico.





# Smile

Proiettore cilindrico in alluminio (estrusione + lavorazione CNC + forgiatura) adatto per installazione su binario trifase. Verniciatura a polveri in bianco o nero, testata girevole 350° e orient. 90°; il driver di alimentazione è incluso e trova alloggiamento nel corpo cilindrico del proiettore stesso.

Sorgente luminosa con tecnologia COB LED integrato, disponibile con una temperatura di colore di 3000 K o 4000K e con indice di resa cromatica fino a 90; binning iniziale ≤4-Step MacAdam; min. 80% di flusso luminoso rimanente dopo 50.000 h di durata; ottica a fascio simmetrico con tre diversi angoli di emissione e controllo dell'abbagliamento (UGR <19). Montaggio e smontaggio senza utensili. Protezione IP20; classe isolamento II. Ideale per l'illuminazione di grandi ambienti dove viene richiesta ampia flessibilità e resa cromatica, ad esempio spazi MUSEALI, COMMERCIALI e RETAIL.

<b>Sorgente</b>	LED COB
<b>Potenza</b>	15W / 20W / 30W
<b>Driver incluso</b>	On/Off
<b>Driver disponibili</b>	No
<b>Circuito</b>	3+Off
<b>Lumen</b>	1380 / 2850 Lm
<b>MacAdam</b>	4SDC
<b>Angolo</b>	Spot / Flood / Wide Flood
<b>CCT</b>	3000 K / 4000 K
<b>CRI</b>	≥82 / ≥92
<b>UGR</b>	<9
<b>Durata LED</b>	50.000h
<b>Classe isolamento</b>	II
<b>IP</b>	20
<b>Materiale</b>	Alluminio
<b>Garanzia</b>	5 anni



Link Trimless  
Pag. 754



Link Trim  
Pag. 756







# Smile 15W

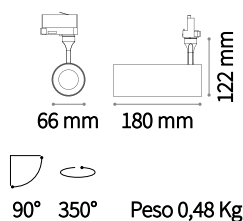

LED COB AND DRIVER HIGH QUALITY\* Driver ON/OFF incluso

CRI ≥82

Potenza	Angolo	Flux	CCT	Finitura	Codice
15 W	24°	1490 Lm	3000 K	Bianco	189574
				Nero	189581
	36°	1490 Lm	3000 K	Bianco	189611
				Nero	189628
	50°	1490 Lm	3000 K	Bianco	189758
				Nero	189765
	36°	1540 Lm	4000 K	Bianco	189796
				Nero	189802
	50°	1490 Lm	3000 K	Bianco	189932
				Nero	189949
	50°	1540 Lm	4000 K	Bianco	189956
				Nero	189963

CRI ≥92

Potenza	Angolo	Flux	CCT	Finitura	Codice
15 W	24°	1380 Lm	3000 K	Bianco	189598
				Nero	189604
	36°	960 Lm	3000 K	Bianco	189772
				Nero	189789
	50°	860 Lm	3000 K	Bianco	189970
				Nero	189987

OPTIONAL Non incluso



Finitura	Codice
Filtro Honeycomb	189536



Finitura	Codice
Filtro Ellittico	189543



Finitura	Codice
Anello Bianco	189505

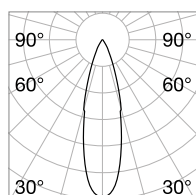

m	lx	ø m
1	4362	0,47
2	1090	0,94
3	484	1,41
4	272	1,88
5	174	2,35

CRI ≥82 15W 24° 1490 Lm 3000 K

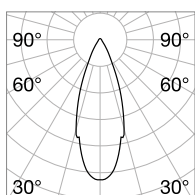

m	lx	ø m
1	2923	0,64
2	730	1,29
3	324	1,94
4	182	2,58
5	116	3,23

CRI ≥82 15W 36° 1490 Lm 3000 K

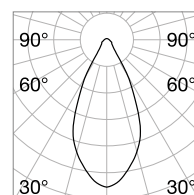

m	lx	ø m
1	1611	0,89
2	402	1,79
3	179	2,69
4	100	3,59
5	64	4,49

CRI ≥82 15W 50° 1490 Lm 3000 K

\*Per ulteriori informazioni, si prega di contattare l'ufficio tecnico.



# Smile 20W

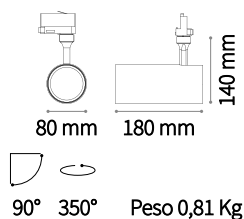

LED COB AND DRIVER HIGH QUALITY\* Driver ON/OFF incluso

CRI ≥82

Potenza	Angolo	Flux	CCT	Finitura	Codice
20 W	20°	2220 Lm	3000 K	Bianco	189635
				Nero	189642
20 W	36°	2220 Lm	3000 K	Bianco	189673
				Nero	189680
		2290 Lm	4000 K	Bianco	189819
				Nero	189826
20 W	45°	2220 Lm	3000 K	Bianco	189857
				Nero	189864
		2290 Lm	4000 K	Bianco	189994
				Nero	190006
20 W	45°	2290 Lm	4000 K	Bianco	190013
				Nero	190020

CRI ≥92

Potenza	Angolo	Flux	CCT	Finitura	Codice
20 W	20°	2050 Lm	3000 K	Bianco	189659
				Nero	189666
20 W	36°	1610 Lm	3000 K	Bianco	189833
				Nero	189840
20 W	45°	1560 Lm	3000 K	Bianco	190037
				Nero	190044

OPTIONAL Non incluso



Finitura	Codice
Filtro Honeycomb	190181



Finitura	Codice
Filtro Ellittico	190259



Finitura	Codice
Anello Bianco	189529

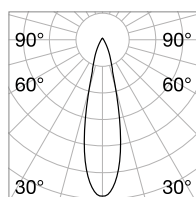

m	lx	øm
1	8787	0,42
2	2196	0,85
3	976	1,28
4	549	1,71
5	351	2,14

CRI≥82 20W 20° 2200 Lm 3000 K

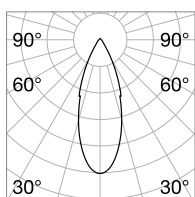

m	lx	øm
1	4526	0,64
2	1131	1,28
3	502	1,92
4	282	2,56
5	181	3,20

CRI≥82 20W 36° 2200 Lm 3000 K

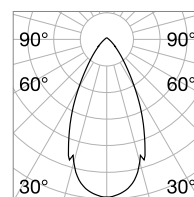

m	lx	øm
1	2657	0,93
2	664	1,87
3	295	2,81
4	166	3,75
5	106	4,69

CRI≥82 20W 45° 2200 Lm 3000 K

\*Per ulteriori informazioni, si prega di contattare l'ufficio tecnico.





# Smile 30W

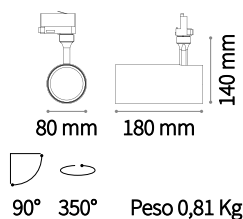

LED COB AND DRIVER HIGH QUALITY\* Driver ON/OFF incluso

CRI ≥82

Potenza	Angolo	Flux	CCT	Finitura	Codice
30 W	20°	2760 Lm	3000 K	Bianco	189697
				Nero	189703
	36°	2760 Lm	3000 K	Bianco	189734
				Nero	189741
	45°	2760 Lm	3000 K	Bianco	189871
				Nero	189888
	2850 Lm	4000 K	Bianco	189895	
			Nero	189901	
	45°	2760 Lm	3000 K	Bianco	190051
				Nero	190068
2850 Lm	4000 K	Bianco	190075		
		Nero	190082		

CRI ≥92

Potenza	Angolo	Flux	CCT	Finitura	Codice
30 W	20°	2560 Lm	3000 K	Bianco	189710
				Nero	189727
	36°	2220 Lm	3000 K	Bianco	189918
				Nero	189925
45°	2210 Lm	3000 K	Bianco	190099	
			Nero	190105	

OPTIONAL Non incluso

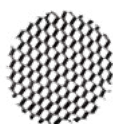

Finitura	Codice
Filtro Honeycomb	190181



Finitura	Codice
Filtro Ellittico	190259



Finitura	Codice
Anello Bianco	189529

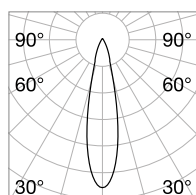

m	lx	øm
1	12955	0,39
2	3238	0,79
3	1439	1,19
4	809	1,59
5	518	1,99

CRI≥82 30W 20° 2760 Lm 3000 K

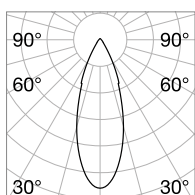

m	lx	øm
1	6240	0,62
2	1560	1,24
3	693	1,86
4	390	2,48
5	249	3,10

CRI≥82 30W 36° 2760 Lm 3000 K

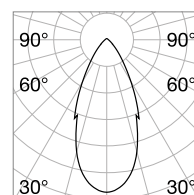

m	lx	øm
1	3740	0,88
2	935	1,76
3	415	2,65
4	233	3,53
5	149	4,42

CRI≥82 30W 45° 2760 Lm 3000 K

\*Per ulteriori informazioni, si prega di contattare l'ufficio tecnico.





# Link

Profilo di alluminio estruso per binari elettrificati trifase; verniciatura a polveri in bianco o nero, ottimizzato per faretti SMILE; disponibile nelle versioni a plafone, a sospensione oppure a incasso a filo su soffitti di cartongesso; adatto a sistemi di file continue, moduli standard da 2000 mm o 3000 mm, sezionabili a misura e componibili secondo schema desiderato.

Ideale per l'installazione in grandi ambienti dove viene richiesta grande flessibilità, ad esempio spazi MUSEALI, COMMERCIALI e RETAIL.

<b>Versione</b>	Trimless / Trim
<b>Lunghezza</b>	2000 mm / 3000 mm
<b>Circuito</b>	Trifase
<b>Materiale</b>	Alluminio
<b>Garanzia</b>	5 anni





# Link Trimless

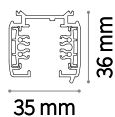

Peso 1,75 Kg

## TRACK 2000 mm

Finitura	Codice
Bianco	187976
Nero	187983

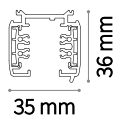

Peso 2,61 Kg

## TRACK 3000 mm

Finitura	Codice
Bianco	187990
Nero	188003

## REQUIRED Non incluso - 1 kit x 1000 mm



	Finitura	Codice
Kit Soffitto	Bianco	169972
	Nero	169989

	Finitura	Codice	Lunghezza cavi
Kit Sospensione	Bianco	169958	1570 mm
	Bianco	216829	5000 mm

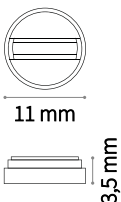

Peso 0,10 Kg

## SINGLE CONNECTION

Finitura	Codice
Bianco	170145
Nero	170152



## MAIN CONNECTOR RIGHT

Peso 0,06 Kg

Codice
169590
169606



## MAIN CONNECTOR LEFT

Peso 0,06 Kg

Codice
169583
169576

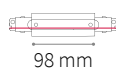

## MIDDLE CONNECTOR

Peso 0,12 Kg

Codice
227580
227597

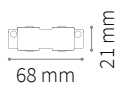

## ELECTRIFIED CONNECTOR

Peso 0,03 Kg

Codice
169637
169644



## END CAP

Peso 0,01 Kg

Codice
169613
169620

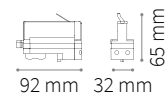

## TRACK CONNECTOR

Peso 0,08 Kg

Codice
194257
194301



B 169972  
N 169989  
KIT SOFFITTO



169958  
KIT SOSPENSIONE

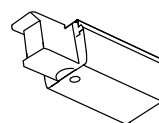
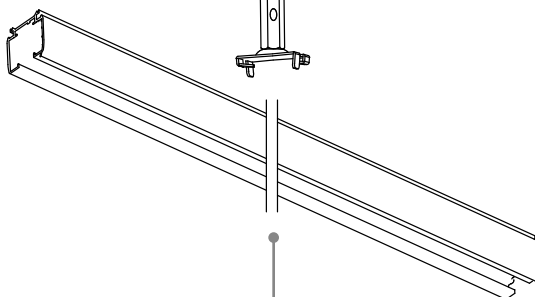
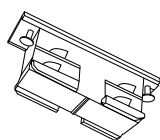
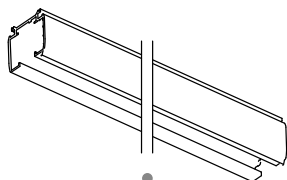

B 169613  
N 169620  
CAPPUCCIO  
FINALE

B 187976  
N 187983  
BINARIO 2 m

B 169637  
N 169644  
CONNETTORE  
DI CONTINUITÀ

B 187990  
N 188003  
BINARIO 3 m

B 169590  
N 169606  
ALLACCIAMENTO  
DESTRO

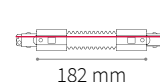
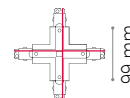
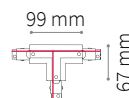
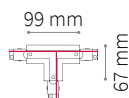
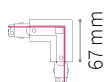
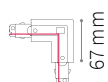

RIGHT L  
CONNECTOR

LEFT L  
CONNECTOR

RIGHT T  
CONNECTOR

LEFT L  
CONNECTOR

X CONNECTOR

FLEXIBLE  
CONNECTOR

Peso 0,11 Kg

Peso 0,11 Kg

Peso 0,18 Kg

Peso 0,18 Kg

Peso 0,23 Kg

Peso 0,16 Kg

Codice

Codice

Codice

Codice

Codice

Codice

■ 169736  
■ 169729

■ 169705  
■ 169712

■ 172781  
■ 169804

■ 169781  
■ 169798

■ 169897  
■ 169903

■ 169910  
■ 169927

# Link Trim

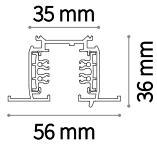

Peso 1,85 Kg

## TRACK 2000 mm

Finitura	Codice
Bianco	188010
Nero	188027

## REQUIRED Non incluso - 1 kit x 1000 mm



	Codice
Kit Incasso	188195



### MAIN CONNECTOR RIGHT

Peso 0,07 Kg

Codice
188058
188065



### MAIN CONNECTOR LEFT

Peso 0,07 Kg

Codice
188072
188089

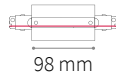

### MIDDLE CONNECTOR

Peso 0,13 Kg

Codice
227689
227672

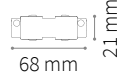

### ELECTRIFIED CONNECTOR

Peso 0,03 Kg

Codice
169637
169644



### END CAP

Peso 0,01 Kg

Codice
169613
169620



### TRACK CONNECTOR

Peso 0,08 Kg

Codice
194257
194301



**B 169613**  
**N 169620**  
CAPPUCCIO  
FINALE

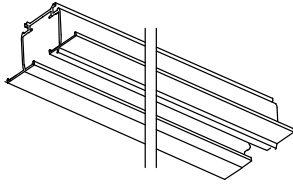

**B 188010**  
**N 188027**  
BINARIO 2 m

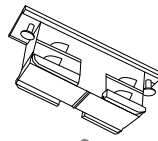

**B 169637**  
**N 169644**  
CONNETTORE  
DI CONTINUITÀ

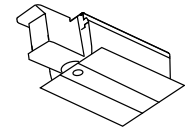
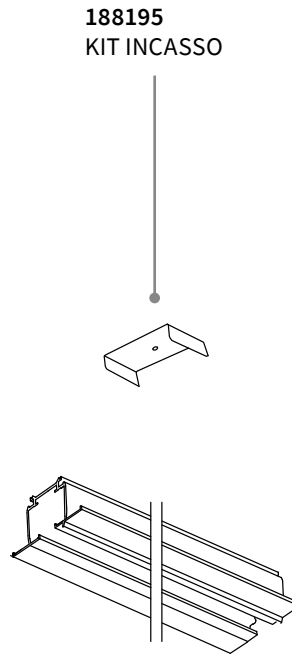

**B 188058**  
**N 188065**  
ALLACCIAMENTO  
DESTRO

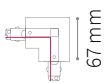

**RIGHT L  
CONNECTOR**

Peso 0,12 Kg

Codice

■ 188096  
■ 188102

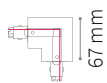

**LEFT L  
CONNECTOR**

Peso 0,12 Kg

Codice

■ 188119  
■ 188126

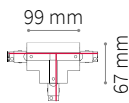

**RIGHT T  
CONNECTOR**

Peso 0,19 Kg

Codice

■ 188133  
■ 188140

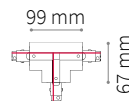

**LEFT L  
CONNECTOR**

Peso 0,19 Kg

Codice

■ 188157  
■ 188164



**X CONNECTOR**

Peso 0,24 Kg

Codice

■ 188171  
■ 188188

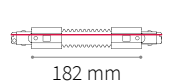

**FLEXIBLE  
CONNECTOR**

Peso 0,16 Kg

Codice

■ 169910  
■ 169927





# Slot

Profilo in alluminio estruso con superficie verniciata a polveri bianca e cover opalina in PMMA. Barre a diverse sezioni in opzione incasso nella versione RECESSED per soffitti in cartongesso e nella versione SURFACE per installazione a parete o soffitto.

I moduli lineari sono disponibili nelle lunghezze di 1000, 2000 e 3000 mm, sono componibili a seconda del disegno desiderato e sezionabili a misura.

Led e driver da abbinare per una corretta installazione. Sorgente luminosa disponibile con temperatura di colore di 2700 K, 3000 K, 4000 K; CRI  $\geq 80$ ; disponibile con protezione IP20 e IP65.

<b>Versione</b>	Recessed / Surface
<b>Lunghezza</b>	1000 / 2000 / 3000 mm
<b>Larghezza</b>	11 / 20 mm
<b>Materiale</b>	Alluminio





# Slot Recessed

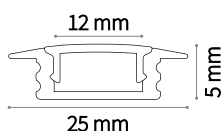

## PROFILE 12 mm Kit per montaggio incluso

Lunghezza	Peso	Finitura	Codice
1000 mm	0,15 Kg	Bianco	124155
2000 mm	0,35 Kg	Bianco	203102
3000 mm	0,54 Kg	Bianco	204611

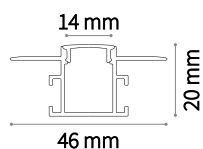

## PROFILE 14 mm

Lunghezza	Peso	Finitura	Codice
2000 mm	0,65 Kg	Bianco	223704
3000 mm	0,90 Kg	Bianco	223711

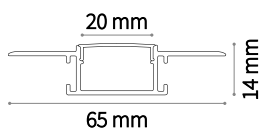

## PROFILE 20 mm

Lunghezza	Peso	Finitura	Codice
2000 mm	0,60 Kg	Bianco	223728
3000 mm	0,90 Kg	Bianco	223735

## REQUIRED Non incluso



	Finitura	Codice
Kit Lineare	Grigio	223766



	Finitura	Codice
Kit Destra - Sinistra	Grigio	223759



	Finitura	Codice
Kit Verticale - Orizzontale	Grigio	223742





223704  
223711

223728  
223735



124155  
203102  
204611

223728  
223735

Kit per montaggio profilo 12 mm.

# Slot Surface

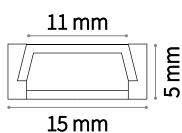

## FLAT PROFILE Kit per montaggio incluso

Lunghezza	Peso	Finitura	Codice
1000 mm	0,40 Kg	Bianco	124131
	0,40 Kg	Grigio	124124
2000 mm	0,64 Kg	Bianco	203089
	0,64 Kg	Grigio	203072
3000 mm	0,94 Kg	Bianco	204598
	0,94 Kg	Grigio	204581

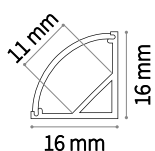

## ANGULAR PROFILE Kit per montaggio incluso

Lunghezza	Peso	Finitura	Codice
1000 mm	0,40 Kg	Bianco	126548
	0,40 Kg	Grigio	126531
2000 mm	0,70 Kg	Bianco	203126
	0,70 Kg	Grigio	203119
3000 mm	1,09 Kg	Bianco	204635
	1,09 Kg	Grigio	204628





Kit per montaggio profilo a vista.



Kit per montaggio profilo angolare.



# Slot - Strip LED and Driver

## STRIP LED Non incluso/Necessario



Potenza	Flux	CCT	IP	Codice
13 W	1200 Lm	2700 K	IP20	<b>183336</b>
	1100 Lm	3000 K	IP20	<b>124032</b>
			IP65	<b>124056</b>
			4000 K	IP20
		IP65	<b>124063</b>	



Potenza	Flux	CCT	IP	Codice
26 W	2200 Lm	2700 K	IP20	<b>183343</b>
	1500 Lm	3000 K	IP20	<b>151847</b>
	1600 Lm	4000 K	IP20	<b>151854</b>

## DRIVER Non incluso/Necessario



Potenza	Output	Corrente	Misura	Codice
30 W	24 V	1250 mA	54 x 35 x 97 mm	<b>124070</b>
60 W	24 V	2500 mA	54 x 37 x 157 mm	<b>124087</b>
100 W	24 V	4500 mA	98 x 30 x 133 mm	<b>124100</b>
150 W	24 V	6500 mA	98 x 30 x 100 mm	<b>124117</b>
200 W	24 V	8300 mA	115 x 30 x 220 mm	<b>153001</b>



# Faretti da incasso







# Lika

Famiglia di moduli ad incasso rettangolare in alluminio pressofuso, verniciato nero con riflettore in policarbonato. Disponibili nelle versioni TRIM con cornice oppure TRIMLESS con bordo arretrato per installazione a filo su soffitti in cartongesso. Moduli disponibili con lente singola, doppia, a cinque oppure dieci lenti. Sorgente luminosa con tecnologia SMD LED, disponibile con una temperatura di colore di 3000 K; LED ad efficienza energetica ad elevata resa cromatica; CRI  $\geq 90$ ; min. 80% di flusso luminoso rimanente dopo 30000 h di durata; protezione IP 20; classe isolamento II. Appositamente disegnato per evitare abbagliamenti (UGR  $< 19$ ), trova la sua migliore collocazione all'interno di UFFICI e spazi COMMERCIALI.

<b>Sorgente</b>	LED SMD
<b>Potenza</b>	2W / 4W / 10W / 20W
<b>Driver incluso</b>	On/Off
<b>Driver disponibili</b>	No
<b>Kit emergency</b>	Disponibile
<b>Lumen</b>	220 / 2200 Lm
<b>MacAdam</b>	5SDC
<b>Angolo</b>	45°
<b>CCT</b>	3000 K
<b>CRI</b>	$\geq 90$
<b>UGR</b>	$< 19$
<b>Durata LED</b>	30.000 h
<b>Classe isolamento</b>	II
<b>IP</b>	20
<b>Materiale</b>	Alluminio
<b>Garanzia</b>	3 anni







# Lika Trim

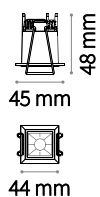

37 x 37 mm  
Peso 0,08 Kg

**LED COB AND DRIVER HIGH QUALITY\*** Driver ON/OFF incluso

Potenza	Angolo	Flux	CCT	Finitura	Codice
2 W	45°	220 Lm	3000 K	Nero	■ 206141

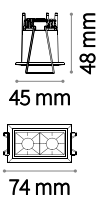

68 x 37 mm  
Peso 0,13 Kg

**LED COB AND DRIVER HIGH QUALITY\*** Driver ON/OFF incluso

Potenza	Angolo	Flux	CCT	Finitura	Codice
4 W	45°	440 Lm	3000 K	Nero	■ 206196

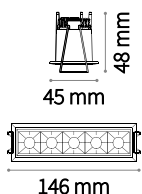

140 x 37 mm  
Peso 0,24 Kg

**LED COB AND DRIVER HIGH QUALITY\*** Driver ON/OFF incluso

Potenza	Angolo	Flux	CCT	Finitura	Codice
10 W	45°	1100 Lm	3000 K	Nero	■ 206219

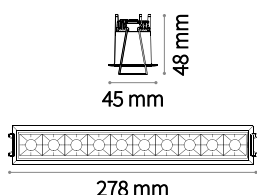

273 x 37 mm  
Peso 0,48 Kg

**LED COB AND DRIVER HIGH QUALITY\*** Driver ON/OFF incluso

Potenza	Angolo	Flux	CCT	Finitura	Codice
20 W	45°	2200 Lm	3000 K	Nero	■ 206233

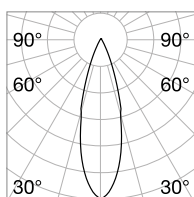

m	lx	øm
1	2786	0,58
2	696	1,16
3	309	1,74
4	174	2,32
5	111	2,90

CRI≥90 10W 45° 1100 Lm 3000K

\*Per ulteriori informazioni, si prega di contattare l'ufficio tecnico.

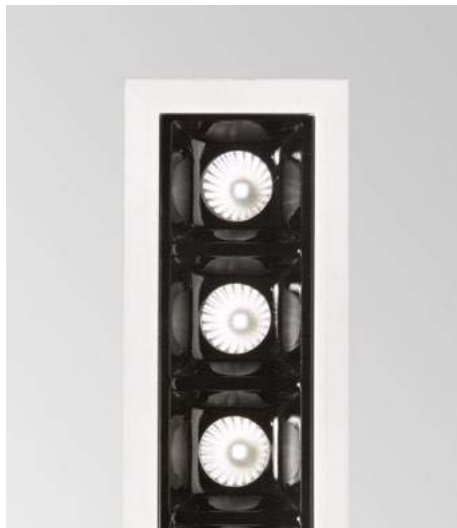

# Lika Trimless

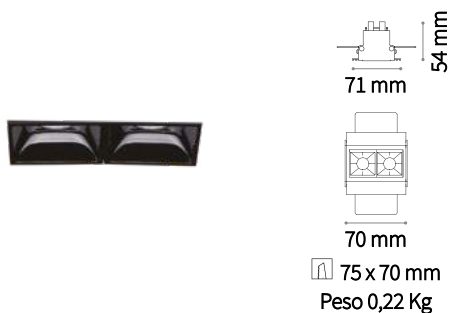

LED COB AND DRIVER HIGH QUALITY\* Driver ON/OFF incluso

Potenza	Angolo	Flux	CCT	Finitura	Codice
4 W	45°	440 Lm	3000 K	Nero	■ 206202

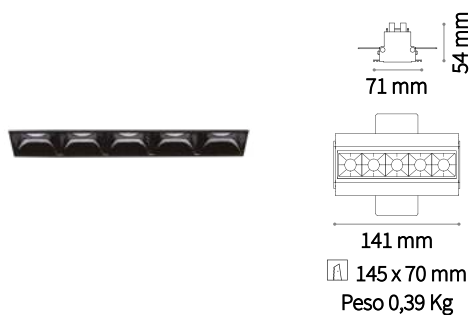

LED COB AND DRIVER HIGH QUALITY\* Driver ON/OFF incluso

Potenza	Angolo	Flux	CCT	Finitura	Codice
10 W	45°	1100 Lm	3000 K	Nero	■ 206226

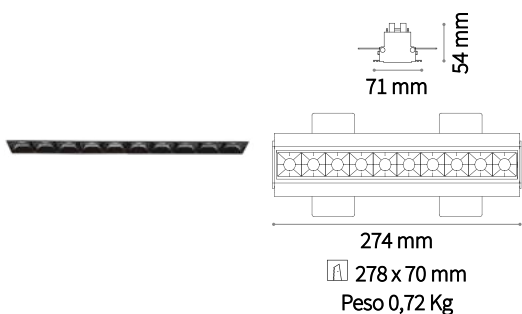

LED COB AND DRIVER HIGH QUALITY\* Driver ON/OFF incluso

Potenza	Angolo	Flux	CCT	Finitura	Codice
20 W	45°	2200 Lm	3000 K	Nero	■ 206240

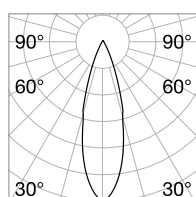

m	lx	ø m
1	2786	0,58
2	696	1,16
3	309	1,74
4	174	2,32
5	111	2,90

CRI≥90 10W 45° 1100 Lm 3000K

\*Per ulteriori informazioni, si prega di contattare l'ufficio tecnico.





# Dynamic

Sistema componibile di elementi ad incasso in alluminio costituito da sorgente, riflettore e ghiera, con lenti e schermi in opzione; finitura bianca, cromo, nera, oro; incasso possibile di forma rotonda o quadrata, riflettore simmetrico o asimmetrico; tre diversi angoli di emissione a scelta. Sorgente luminosa con tecnologia COB LED integrato per la massima efficienza, disponibile con una temperatura di colore di 2700 K, 3000 K o 4000 K; LED ad efficienza energetica ad elevata resa cromatica; CRI  $\geq 90$ ; binning iniziale  $\leq 3$ -Step MacAdam; min. 80% di flusso luminoso rimanente dopo 50000 h di durata; protezione IP54; classe isolamento II. Disponibile in versione dimmerabile sia DALI che 1-10V. Per la sua dimensione compatta e grande versatilità è ottimale nelle installazioni di ambienti interni DOMESTICI, DIREZIONALI e RETAIL.

<b>Sorgente</b>	LED COB
<b>Potenza</b>	10W / 15W
<b>Driver incluso</b>	On/Off
<b>Driver disponibili</b>	1-10V / DALI
<b>Kit emergency</b>	Disponibile
<b>Lumen</b>	1050 / 1600 Lm
<b>MacAdam</b>	3SDC
<b>Angolo</b>	35°
<b>CCT</b>	2700 K / 3000 K / 4000 K
<b>CRI</b>	$\geq 90$
<b>Durata LED</b>	50.000 h
<b>Classe isolamento</b>	II
<b>IP</b>	54
<b>Materiale</b>	Alluminio
<b>Garanzia</b>	5 anni







# Dynamic - Source

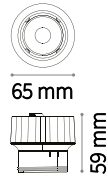

Peso 0,15 Kg

**SOURCE** Non incluso/Necessario - Driver ON/OFF e lente 35° inclusi.

Potenza	Angolo	Flux	CCT	Finitura	Codice
10 W	35°	1050 Lm	2700 K	Nero	■ 208541
		1100 Lm	3000 K	Nero	■ 208558
		1200 Lm	4000 K	Nero	■ 208565

**DIMMABLE DRIVER** Non incluso/Optional

	Potenza	Output	Corrente	Misura	Codice
1-10V	10 W	10/40Vdc	250 mA	135x20x30 mm	216317
DALI	13 W	15/50Vdc	250 mA	130x30x43 mm	216027

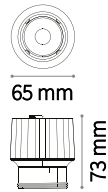

Peso 0,20 Kg

**SOURCE** Non incluso/Necessario - Driver ON/OFF e lente 35° inclusi.

Potenza	Angolo	Flux	CCT	Finitura	Codice
15 W	35°	1400 Lm	2700 K	Nero	■ 208572
		1500 Lm	3000 K	Nero	■ 208589
		1600 Lm	4000 K	Nero	■ 208596

**DIMMABLE DRIVER** Non incluso/Optional

	Potenza	Output	Corrente	Misura	Codice
1-10V	19 W	27/54Vdc	350 mA	101x29x51 mm	216324
DALI	17 W	15/49Vdc	350 mA	130x30x43 mm	216263

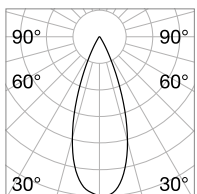

m	lx	øm
1	1643	0,66
2	410	1,32
3	182	1,98
4	102	2,64
5	65	3,30

CRI≥90 10W 35° 1100 Lm 3000K

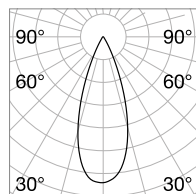

m	lx	øm
1	2294	0,64
2	573	1,29
3	254	1,93
4	143	2,58
5	91	3,23

CRI≥90 15W 35° 1500 Lm 3000K

\*Per ulteriori informazioni, si prega di contattare l'ufficio tecnico.

# Dynamic - Optional

LENS Non incluso/Optional



Angolo	Codice
20°	211763
55°	211770

FILTER Non incluso/Optional



Finitura	Codice
Honeycomb	208671



Finitura	Codice
Ellittico	208688

GU10 ADAPTOR Non incluso/Optional



Finitura	Codice
Bianco	208640
Nero	208657



# Dynamic Round

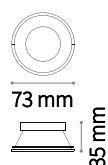

Peso 0,02 Kg

**REFLECTOR** Non incluso/Necessario

**SIMMETRICO**

Finitura	Codice
Bianco	211787
Cromo	221649
Nero	211794
Oro	211800

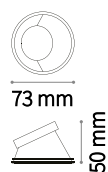

Peso 0,02 Kg

**ASIMMETRICO - 30°**

Finitura	Codice
Bianco	211848
Cromo	221663
Nero	211855
Oro	211862

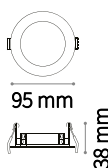

⌀ 80 mm  
Peso 0,06 Kg

**FRAME** Non incluso/Necessario

Finitura	Codice
Bianco	208695
Cromo	221687
Nero	208701
Oro	208718





# Dynamic Square

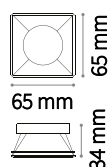

Peso 0,02 Kg

**REFLECTOR** Non incluso/Necessario

## SIMMETRICO

Finitura		Codice
Bianco		211817
Cromo		221656
Nero		211824
Oro		211831

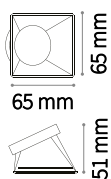

Peso 0,02 Kg

## ASIMMETRICO - 30°

Finitura		Codice
Bianco		211879
Cromo		221670
Nero		211886
Oro		211893

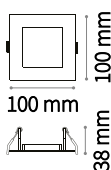

Ⓜ 90 mm  
Peso 0,05 Kg

**FRAME** Non incluso/Necessario

Finitura		Codice
Bianco		208725
Cromo		221694
Nero		208732
Oro		208749







# Game

Faretto ad incasso in alluminio pressofuso con ghiera rotonda o quadrata, adatto per installazione su soffitti in cartongesso. Finitura cromata opaca, bianca opaca RAL 9001, nera opaca RAL 9011, oro opaca RAL 6464. LED raffreddati passivamente; tecnologia COB-Chip On Board per la massima efficienza; disponibile in temperatura di colore 3000 K; CRI  $\geq$  80; min. 80% di flusso luminoso rimanente dopo 30000 h di durata. Montaggio e smontaggio senza utensili; protezione IP20; classe isolamento II. In opzione dimmerabile 1-10V e DALI.

<b>Sorgente</b>	LED COB
<b>Potenza</b>	12W
<b>Driver incluso</b>	On/Off
<b>Driver disponibili</b>	1-10V / DALI
<b>Kit emergency</b>	Disponibile
<b>Lumen</b>	850 Lm
<b>MacAdam</b>	5SDC
<b>Angolo</b>	36°
<b>CCT</b>	3000 K
<b>CRI</b>	$\geq$ 85
<b>UGR</b>	<19
<b>Durata LED</b>	30.000 h
<b>Classe isolamento</b>	II
<b>IP</b>	20
<b>Materiale</b>	Alluminio
<b>Garanzia</b>	5 anni







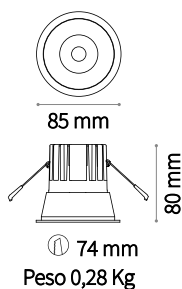





# Game Round







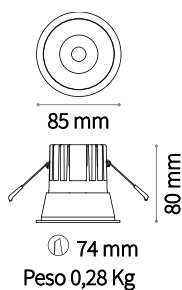



**LED COB AND DRIVER HIGH QUALITY\*** Driver ON/OFF incluso

Potenza	Angolo	Flux	CCT	Finitura	Codice
12 W	36°	850 Lm	3000 K	Argento  + 	<b>192284</b>
				Bianco  + 	<b>192291</b>
				Nero  + 	<b>192277</b>
				Oro  + 	<b>192307</b>



**LED COB AND DRIVER HIGH QUALITY\*** Driver ON/OFF incluso

Potenza	Angolo	Flux	CCT	Finitura	Codice
12 W	36°	850 Lm	3000 K	Argento  + 	<b>192321</b>
				Bianco  + 	<b>192338</b>
				Nero  + 	<b>192314</b>
				Oro  + 	<b>192345</b>

**DIMMABLE DRIVER** Non incluso/Optional

	Potenza	Output	Corrente	Misura	Codice
1-10V	12 W	9/40 Vdc	300 mA	150x43x29 mm	<b>217253</b>
DALI	10 W	10/28 Vdc	350 mA	135x20x30 mm	<b>202396</b>

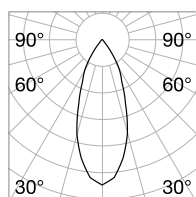

m	lx	øm
1	1545	0,69
2	386	1,38
3	171	2,07
4	96	2,77
5	61	3,46

CRI≥85 12W 36° 850 Lm 3000K

\*Per ulteriori informazioni, si prega di contattare l'ufficio tecnico.





# Game Square

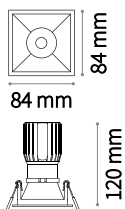

75 mm  
Peso 0,27 Kg

**LED COB AND DRIVER HIGH QUALITY\*** Driver ON/OFF incluso

Potenza	Angolo	Flux	CCT	Finitura	Codice
12 W	36°	850 Lm	3000 K	Argento +	<b>192369</b>
				Bianco +	<b>192376</b>
				Nero +	<b>192352</b>

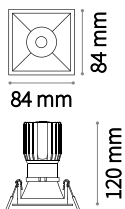

75 mm  
Peso 0,27 Kg

**LED COB AND DRIVER HIGH QUALITY\*** Driver ON/OFF incluso

Potenza	Angolo	Flux	CCT	Finitura	Codice
12 W	36°	850 Lm	3000 K	Argento +	<b>192390</b>
				Bianco +	<b>192406</b>
				Nero +	<b>192383</b>

**DIMMABLE DRIVER** Non incluso/Optional

	Potenza	Output	Corrente	Misura	Codice
1-10V	12 W	9/40 Vdc	300 mA	150x43x29 mm	<b>217253</b>
DALI	10 W	10/28 Vdc	350 mA	135x20x30 mm	<b>202396</b>

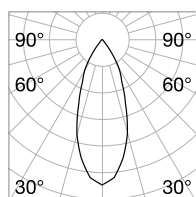

m	lx	øm
1	1545	0,69
2	386	1,38
3	171	2,07
4	96	2,77
5	61	3,46

CRI≥85 12W 36° 850 Lm 3000K

\*Per ulteriori informazioni, si prega di contattare l'ufficio tecnico.





# Basic

Faretto a incasso in alluminio pressofuso con ghiera rotonda, adatto per installazione su soffitti in cartongesso. Finitura bianca opaca; tecnologia COB Chip on Board e SMD. Disponibile in temperatura di colore 3000 K e 4000 K e con tre diverse ottiche; CRI  $\geq 80$ ; protezione IP20; classe isolamento II.

<b>Sorgente</b>	LED COB / SMD
<b>Potenza</b>	10W / 40W
<b>Driver incluso</b>	On/Off
<b>Driver disponibili</b>	1-10V / DALI
<b>Kit emergency</b>	Disponibile
<b>Lumen</b>	820 / 4120 Lm
<b>MacAdam</b>	4SDC
<b>Angolo</b>	50° / 90°
<b>CCT</b>	3000 K / 4000 K
<b>CRI</b>	$\geq 80$
<b>UGR</b>	<17 / <24
<b>Durata LED</b>	30.000 h
<b>Classe isolamento</b>	II
<b>IP</b>	44
<b>Materiale</b>	Alluminio
<b>Garanzia</b>	5 anni





# Basic Accent

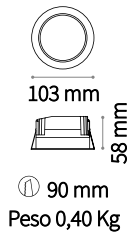

## LED COB AND DRIVER HIGH QUALITY\* Driver ON/OFF incluso

Potenza	Angolo	Flux	CCT	Finitura	Codice	UGR
10 W	60°	1000 Lm	3000 K	Bianco	193458	<17
		1050 Lm	4000 K	Bianco	193359	<17



## LED COB AND DRIVER HIGH QUALITY\* Driver ON/OFF incluso

Potenza	Angolo	Flux	CCT	Finitura	Codice	UGR
15 W	55°	1450 Lm	3000 K	Bianco	193465	<18
		1550 Lm	4000 K	Bianco	193366	<18
20 W		1650 Lm	3000 K	Bianco	193472	<19
		1700 Lm	4000 K	Bianco	193373	<19

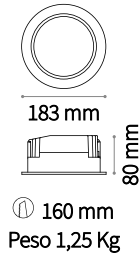

## LED COB AND DRIVER HIGH QUALITY\* Driver ON/OFF incluso

Potenza	Angolo	Flux	CCT	Finitura	Codice	UGR
30 W	50°	2400 Lm	3000 K	Bianco	193489	<20
		2550 Lm	4000 K	Bianco	193380	<20
40 W		3850 Lm	3000 K	Bianco	193502	<21
		3950 Lm	4000 K	Bianco	193397	<21

## DIMMABLE DRIVER Non incluso/Optional

	Potenza	Output	Corrente	Misura	Codice
1-10V	12 W	9/40Vdc	300 mA	150x43x29 mm	218823
	15 W	9/33Vdc	450 mA	150x43x29 mm	218830
	20 W	9/28Vdc	700 mA	150x43x29 mm	218847
	31 W	9/34Vdc	900 mA	150x43x29 mm	218854
	40W	9/40Vdc	1000 mA	137x82x31 mm	218861
DALI	10 W	15/25Vdc	400 mA	130x43x30 mm	220772
	17 W	15/24Vdc	700 mA	130x43x30 mm	220796
	24 W	20/23Vdc	1050 mA	130x43x30 mm	220789
	35 W	25/50Vdc	700 mA	150x43x30 mm	220802
	44 W	25/42Vdc	1050 mA	150x43x30 mm	227634

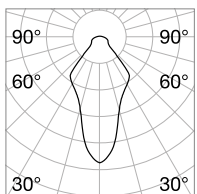

m	lx	øm
1	533	0,81
2	133	1,62
3	59	2,44
4	33	3,25
5	21	4,07

CRI≥80 10W 60° 1000 Lm 3000 K

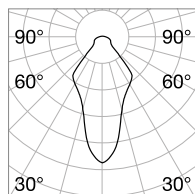

m	lx	øm
1	719	0,98
2	179	1,96
3	79	2,95
4	44	3,93
5	28	4,92

CRI≥80 15W 55° 1450 Lm 3000 K

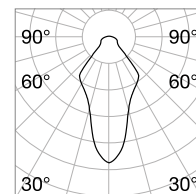

m	lx	øm
1	1250	0,92
2	312	1,84
3	138	2,76
4	78	3,69
5	50	4,61

CRI≥80 30W 50° 2400 Lm 3000 K

\*Per ulteriori informazioni, si prega di contattare l'ufficio tecnico.





# Basic Wide

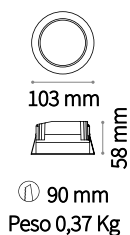

## LED COB AND DRIVER HIGH QUALITY\* Driver ON/OFF incluso

Potenza	Angolo	Flux	CCT	Finitura	Codice	UGR
10 W	85°	900 Lm	3000 K	Bianco	<b>193519</b>	<18
		950 Lm	4000 K	Bianco	<b>193403</b>	<18



## LED COB AND DRIVER HIGH QUALITY\* Driver ON/OFF incluso

Potenza	Angolo	Flux	CCT	Finitura	Codice	UGR
15 W	87°	1400 Lm	3000 K	Bianco	<b>193526</b>	<19
		1450 Lm	4000 K	Bianco	<b>193410</b>	<19
20 W		1800 Lm	3000 K	Bianco	<b>193533</b>	<21
		1900 Lm	4000 K	Bianco	<b>193427</b>	<21

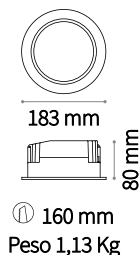

## LED COB AND DRIVER HIGH QUALITY\* Driver ON/OFF incluso

Potenza	Angolo	Flux	CCT	Finitura	Codice	UGR
30 W	90°	2800 Lm	3000 K	Bianco	<b>193540</b>	<22
		2950 Lm	4000 K	Bianco	<b>193434</b>	<22
40 W		3850 Lm	3000 K	Bianco	<b>193557</b>	<24
		3950 Lm	4000 K	Bianco	<b>193441</b>	<24

## DIMMABLE DRIVER Non incluso/Optional

	Potenza	Output	Corrente	Misura	Codice
1-10V	12 W	9/40Vdc	300 mA	150x43x29 mm	<b>218823</b>
	15 W	9/33Vdc	450 mA	150x43x29 mm	<b>218830</b>
	20 W	9/28Vdc	700 mA	150x43x29 mm	<b>218847</b>
	31 W	9/34Vdc	900 mA	150x43x29 mm	<b>218854</b>
	40W	9/40Vdc	1000 mA	137x82x31 mm	<b>218861</b>
DALI	10 W	15/25Vdc	400 mA	130x43x30 mm	<b>220772</b>
	17 W	15/24Vdc	700 mA	130x43x30 mm	<b>220796</b>
	24 W	20/23Vdc	1050 mA	130x43x30 mm	<b>220789</b>
	35 W	25/50Vdc	700 mA	150x43x30 mm	<b>220802</b>
	44 W	25/42Vdc	1050 mA	150x43x30 mm	<b>227634</b>

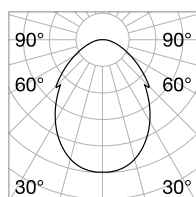

m	lx	øm
1	188	1,84
2	47	3,69
3	20	5,54
4	11	7,39
5	7	9,24

CRI≥80 10W 85° 900 Lm 3000 K

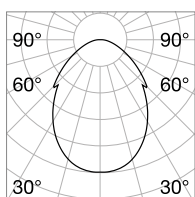

m	lx	øm
1	318	1,72
2	79	3,44
3	35	5,17
4	19	6,89
5	12	8,61

CRI≥80 15W 87° 1400 Lm 3000 K

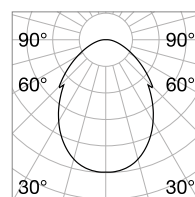

m	lx	øm
1	591	1,84
2	147	3,69
3	65	5,53
4	36	7,38
5	23	9,23

CRI≥80 30W 90° 2800 Lm 3000 K

\*Per ulteriori informazioni, si prega di contattare l'ufficio tecnico.

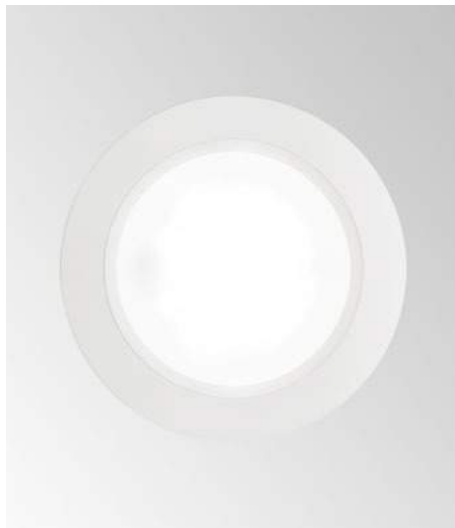



# Groove

IP20 CRI ≥80 30.000 h ALLUMINIO

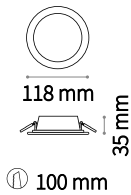

LED SMD AND DRIVER Incluso

Potenza	Angolo	Flux	CCT	Finitura	Codice
10 W	90°	700 Lm	3000 K	Bianco	123974
		800 Lm	4000 K	Bianco	147666

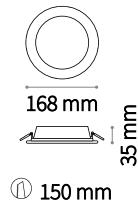

LED SMD AND DRIVER Incluso

Potenza	Angolo	Flux	CCT	Finitura	Codice
20 W	90°	1400 Lm	3000 K	Bianco	123998
		1600 Lm	4000 K	Bianco	147673

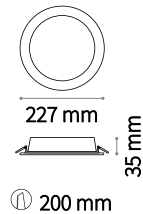

LED SMD AND DRIVER Incluso

Potenza	Angolo	Flux	CCT	Finitura	Codice
30 W	90°	2100 Lm	3000 K	Bianco	124018
		2400 Lm	4000 K	Bianco	147680

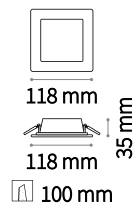

LED SMD AND DRIVER Incluso

Potenza	Angolo	Flux	CCT	Finitura	Codice
10 W	90°	700 Lm	3000 K	Bianco	123981

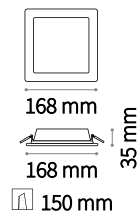

LED SMD AND DRIVER Incluso

Potenza	Angolo	Flux	CCT	Finitura	Codice
20 W	90°	1400 Lm	3000 K	Bianco	124001

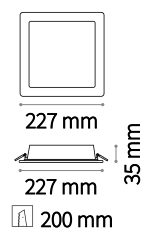

LED SMD AND DRIVER Incluso

Potenza	Angolo	Flux	CCT	Finitura	Codice
30 W	90°	2100 Lm	3000 K	Bianco	124025

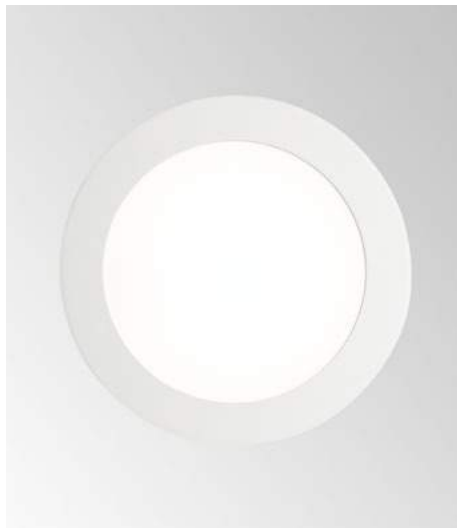

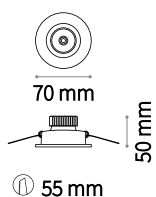

LED COB AND DRIVER Incluso

Potenza	Angolo	Flux	CCT	Finitura	Codice
1 W	60°	90 Lm	4000 K	Bianco	062389

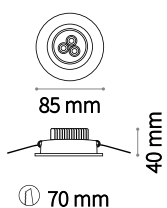

LED COB AND DRIVER Incluso

Potenza	Angolo	Flux	CCT	Finitura	Codice
3 W	60°	270 Lm	4000 K	Bianco	062396

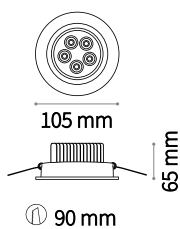

LED COB AND DRIVER Incluso



Potenza	Angolo	Flux	CCT	Finitura	Codice
5 W	60°	450 Lm	4000 K	Bianco	062402









# Eye

 IP20 CRI ≥80 30.000 h ALLUMINIO

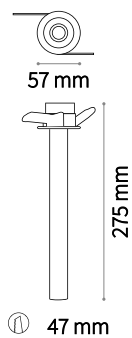
LED COB AND DRIVER Incluso



Potenza	Angolo	Flux	CCT	Finitura	Codice
3 W	15°	270 Lm	3000 K	Bianco	 <b>186986</b>
				Nero	 <b>186993</b>



# Zephyr

IP20 GESSO

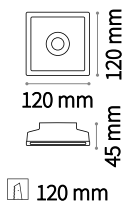

120 mm

GU10 Non inclusa

Potenza	Finitura	Codice
max 35W	Bianco	150284

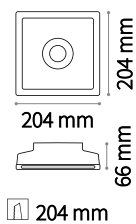

204 mm

GU10 Non inclusa

Potenza	Finitura	Codice
max 35W	Bianco	155722



# Samba Round

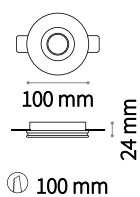

GU10 Non inclusa

Potenza	Finitura	Codice
max 35W	Bianco	■ 150307

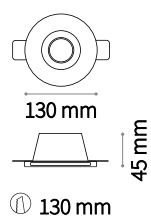

GU10 Non inclusa

Potenza	Finitura	Codice
max 35W	Bianco	■ 150130

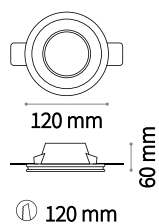

GU10 Non inclusa

Potenza	Finitura	Codice
max 50W	Bianco	■ 139012



# Samba Square

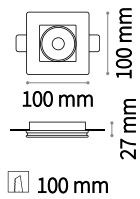

100 mm

GU10 Non inclusa

Potenza	Finitura	Codice
max 35W	Bianco	150291

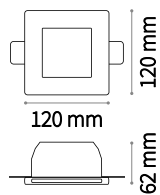

120 mm

GU10 Non inclusa

Potenza	Finitura	Codice
max 35W	Bianco	150116

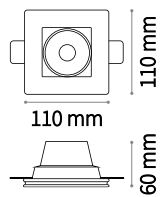

110 mm

GU10 Non inclusa

Potenza	Finitura	Codice
max 50W	Bianco	139029





# Jazz

IP20 ZINCO

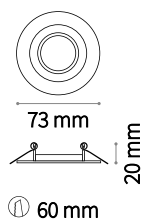

GU10 Non inclusa

Potenza	Finitura	Codice
max 50W	Alluminio	083100
	Bianco	083117
	Brunito	083124
	Cromo	083070
	Nickel	083087

# Swing

IP20 ZINCO

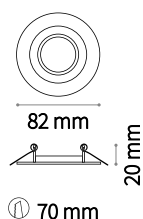

GU10 Non inclusa

Potenza	Finitura	Codice
max 50W	Alluminio	083162
	Bianco	083179
	Brunito	083186
	Cromo	183131
	Nickel	083148

# Lounge

IP20 ZINCO

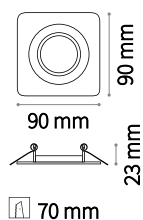

GU10 Non inclusa

Potenza	Finitura	Codice
max 50W	Bianco	138978
	Cromo	138985
	Nickel	138992

# Funky

IP20 FERRO

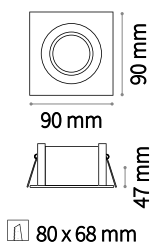

GU10 Non inclusa

Potenza	Finitura	Codice
max 50W	Alluminio	083223
	Bianco	083230
	Brunito	083247
	Cromo	083193
	Nickel	083209



# Blues

IP20 ALLUMINIO

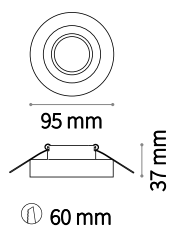

GU10 Non inclusa

Potenza	Finitura	Codice
max 50W	Bianco	<b>113999</b>
	Fumè	<b>113982</b>
	Trasparente	<b>083254</b>

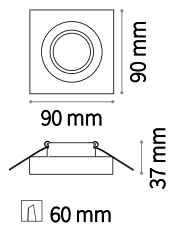

GU10 Non inclusa

Potenza	Finitura	Codice
max 50W	Trasparente	<b>114019</b>





# Parete e soffitto







# Channel

Montatura in alluminio verniciato a polveri. Orientabile in ogni direzione. Monta lampadine sostituibili GU10, Ø 111 mm. Installazione senza incasso.

**LED** Lampadine LED GU10 7W e LED GU10 13W 3000 K incluse. Cod. 101378/189031

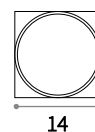
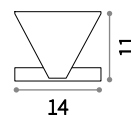

GU10 max 1 x 13W  
203140 ■ Nero

GU10 max 1 x 7W  
203133 ■ Nero







# Nitro

Corpo luce in alluminio verniciato opaco.  
Interno rifinito con mascherina in plastica.  
Sorgente luminosa a led integrato con lente.

**LED** Sorgente luminosa LED 3000 K,  
30.000 h di durata.

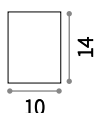

LED 15W / 1350 Lm

205977 ■ Bianco  
205984 ■ Nero

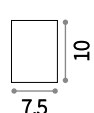

LED 10W / 900 Lm

205991 ■ Bianco  
206004 ■ Nero

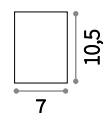

LED 15W / 1350 Lm

206011 ■ Bianco  
206028 ■ Nero

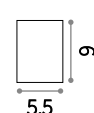

LED 10W / 900 Lm

206035 ■ Bianco  
206042 ■ Nero







# Mood

Corpo luce in metallo disponibile con sezione quadra o tonda. Nero all'interno e varie finiture all'esterno. Diffusore interno orientabile.

 Lampadine ALO GU10 28W e ALO GU10 50W 2700 K incluse.

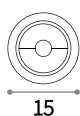
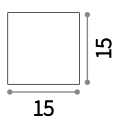

GU10 max 1 x 50W

140896 ■ Alluminio  
140872 ■ Bianco

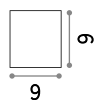

GU10 max 1 x 28W

140865 ■ Alluminio  
140841 ■ Bianco

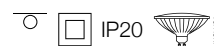
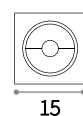
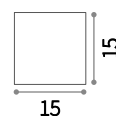

GU10 max 1 x 50W

140957 ■ Alluminio  
140933 ■ Bianco

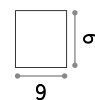

GU10 max 1 x 28W

140926 ■ Alluminio  
140902 ■ Bianco

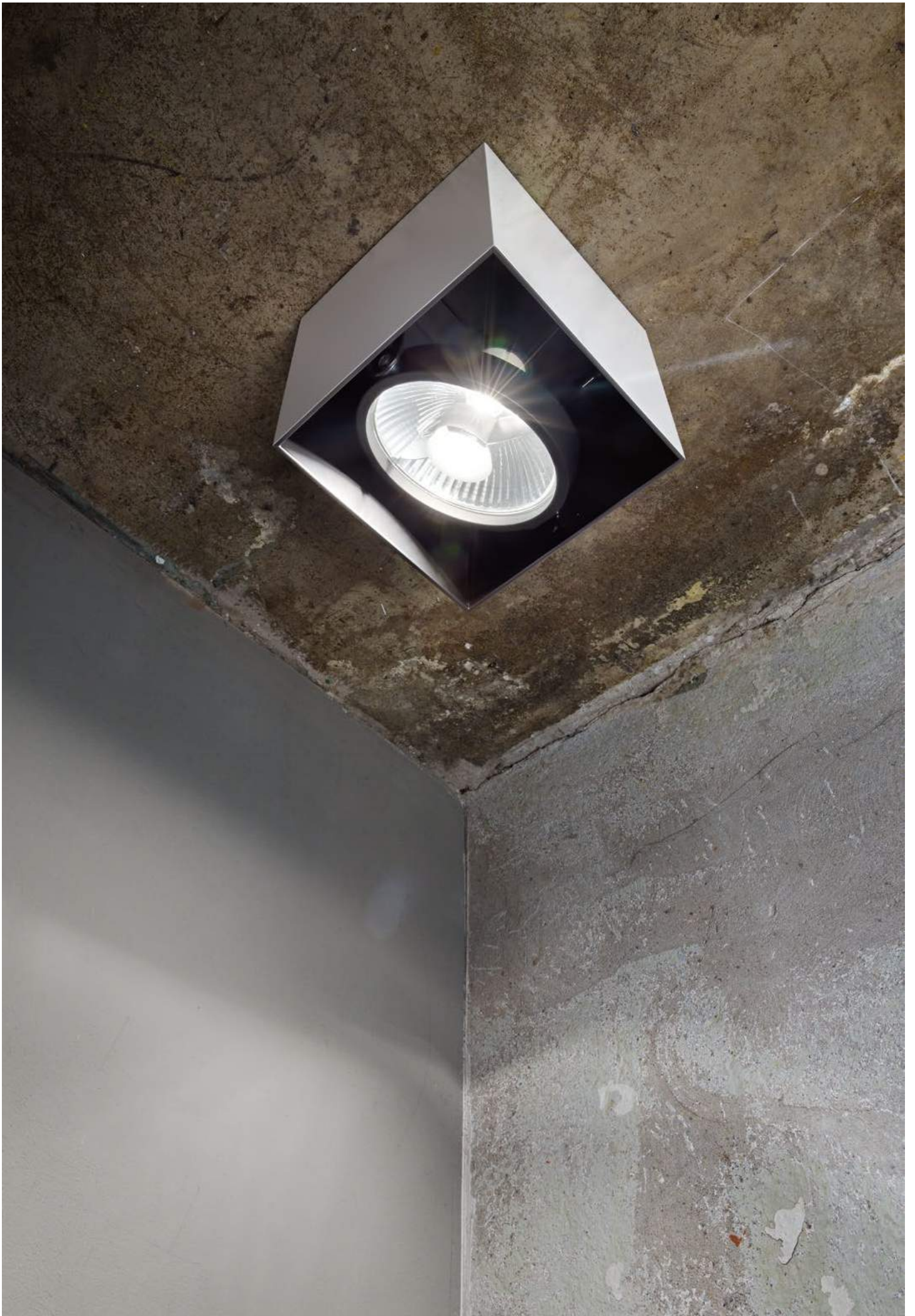



# Halo

Base e corpo luce in alluminio verniciato a polveri. Diffusore in materiale plastico color opale. Sorgente luminosa a led integrati.

**LED** Sorgente luminosa LED 3000/4000 K, 35.000 h di durata.

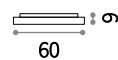

LED 34W / 4300/5000 Lm

223223 ■ Bianco 3000 K  
223230 ■ Bianco 4000 K

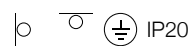

LED 21,5W / 2800/3200 Lm

223209 ■ Bianco 3000 K  
223216 ■ Bianco 4000 K

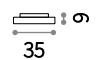

LED 17,2W / 2200/2500 Lm

223186 ■ Bianco 3000 K  
223193 ■ Bianco 4000 K







# Polo

Rosone e montatura in metallo verniciato bianco opaco. Diffusore in policarbonato bianco opaco.

**LED** Sorgente luminosa LED 3000 K, 30.000 h di durata.

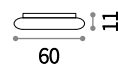

60



60



LED 40W / 3850 Lm

140551 ■ Bianco

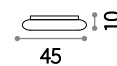

45



45

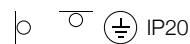

LED 24W / 2100 Lm

140544 ■ Bianco

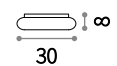

30



30



LED 16W / 1400 Lm

140537 ■ Bianco



# Ufo

Montatura in metallo verniciato bianco opaco. Diffusore in materiale plastico bianco satinato con LED integrati.

**LED** Sorgente luminosa LED 3000 K, 30.000 h di durata.

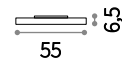

LED 50W / 3500 Lm  
136998 ■ Bianco

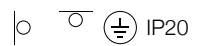
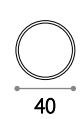
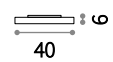

LED 36W / 2500 Lm  
137001 ■ Bianco





# Glim

Montatura interamente in metallo verniciato a polveri. Diffusore orientabile con lampadina sostituibile.

**LED** Lampadine LED GU10 13W 3000 K incluse. Cod. 189031

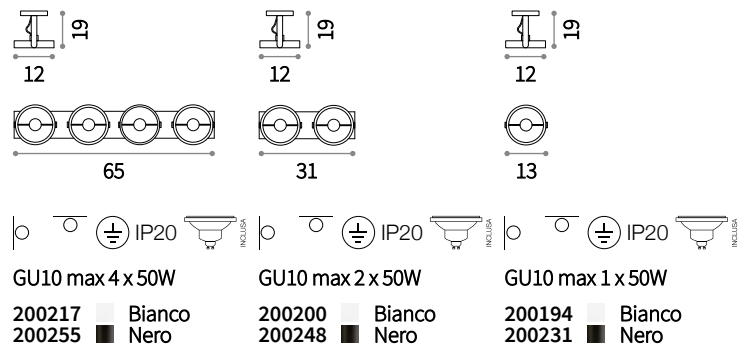





# Garage

Montatura in alluminio verniciato a polveri. Diffusore orientabile con schermo in vetro trasparente. Led integrati.

**LED** Sorgente luminosa LED 3000 K, 50.000 h di durata.

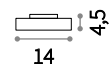

LED 12W / 1080 Lm

205809 ■ Bianco  
205816 ■ Nero

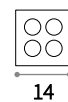
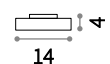

LED 12W / 1080 Lm

205786 ■ Bianco  
205793 ■ Nero





# Oak

Corpo luce in gesso o cemento. Cavo in tessuto nero. Modello PL con elemento portalampada centrale orientabile.

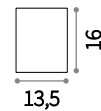

GU10 max 1 x 35W

150420 ■ Bianco  
150437 ■ Cemento

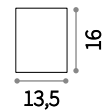

GU10 max 1 x 35W

150468 ■ Bianco  
150475 ■ Cemento



# Mouse

Base, montatura e diffusori in metallo rifinito con vernice opaca e dettagli in cromo. Diffusori orientabili.

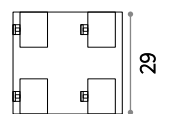
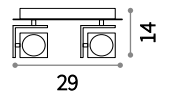

⊕ ⊖ ⊕ IP20

GU10 max 4 x 50W

073583 ■ Bianco  
156712 ■ Nero



# Spot

Base, montatura e diffusori in metallo rifinito con vernice opaca e dettagli in cromo. Diffusori orientabili.

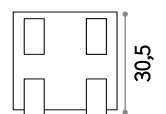
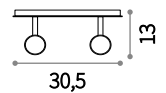

⊕ ⊖ ⊕ IP20

GU10 max 4x50W

156774 ■ Bianco  
156781 ■ Nero





# Tower

Rosone e montatura in metallo verniciato bianco opaco. Diffusore in policarbonato bianco opaco. Sospensioni con cavi in acciaio regolabili in lunghezza da dispositivi automatici.



⊕ IP20

GU10 max 1 x 35W

155869 ■ Bianco



⊕ IP20

GU10 max 1 x 35W

155791 ■ Bianco





# Edgar

Corpo luce in alluminio. Base sagomata per fissaggio diretto sul bordo superiore dello specchio. Alimentatore esterno e cavo a vista. Apparecchio impermeabile con IP44.

**LED** Sorgente luminosa LED 3000 K, 20.000 h di durata.

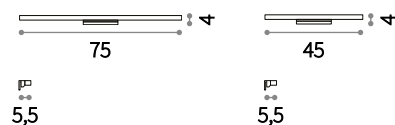

LED 11,76W / 800 Lm

136561 Alluminio  
136578 Bianco

LED 5,88W / 400 Lm

136585 Alluminio  
136592 Bianco







# Riflesso

Montatura in metallo rifinito in cromo o vernice bianca opaca. Diffusore in materiale acrilico trasparente e satinato.

**LED** Sorgente luminosa LED 3000 K, 30.000 h di durata.

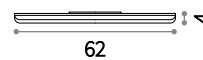

62



9



LED 15,3W / 1350 Lm

142289 ■ Bianco  
142265 ■ Cromo

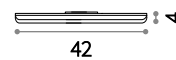

42



9



LED 10,2W / 900 Lm

142296 ■ Bianco  
142272 ■ Cromo







# Garage

Montatura in alluminio verniciato a polveri. Diffusore orientabile con schermo in vetro trasparente. Led integrati.



**LED** Sorgente luminosa LED 3000 K, 50.000 h di durata.

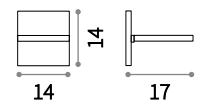
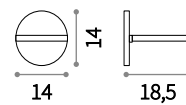

○ □ IP20

○ □ IP20

LED 12W / 1080 Lm

LED 12W / 1080 Lm

205892 ■ Bianco  
205908 ■ Nero

205861 ■ Bianco  
205878 ■ Nero





# Flap

Montatura in metallo rifinito con vernice opaca. Diffusore ruotabile con schermo in acrilico opaco.

**LED** Sorgente luminosa LED 3000 K, 20.000 h di durata.

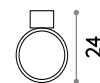
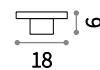

IP20

LED 15W / 1200 Lm

155395 ■ Bianco  
155401 ■ Nero

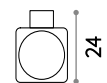
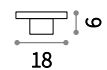

IP20

LED 15W / 1200 Lm

155418 ■ Bianco  
155425 ■ Nero



# Sign

Corpo luce in metallo con finitura in vernice opaca bianca. Diffusori in materiale acrilico trasparente satinato.

**LED** Sorgente luminosa LED 4000 K, 25.000 h di durata.

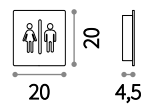

IP20

LED 8W / 640 Lm

122571 ■ Bianco





# Bill

Corpo luce in metallo verniciato opaco. Diffusore in materiale acrilico. Sorgente luminosa a led integrati con emissione verso l'alto.

**LED** Sorgente luminosa LED 3000 K, 20.000 h di durata.

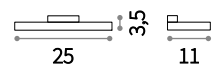

IP20

LED 6W / 527 Lm

201139  Bianco  
201153  Nero



# Cover

Corpo luce in alluminio verniciato a polveri. Diffusore in materiale plastico opale. Sorgente luminosa a led integrati con emissione di luce riflessa.

**LED** Sorgente luminosa LED 3000 K, 17.500 h di durata.

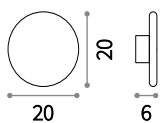

LED 11W / 1112 Lm

195711  Bianco  
195759  Nero

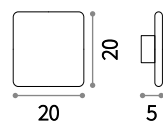

LED 9W / 1112 Lm

195735  Bianco  
195773  Nero

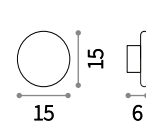

LED 11W / 943 Lm

195704  Bianco  
195742  Nero

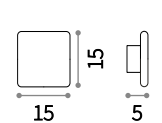

LED 9W / 943 Lm

195728  Bianco  
195766  Nero





# Lola

Corpoluce dissipatore interamente in lastra d'alluminio da 6 mm di spessore. Rifinito con vernice a polveri. LED integrati.

**LED** Sorgente luminosa LED 3000 K, 25.000 h di durata.

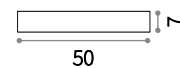

LED 14W / 1120 Lm

162102 ■ Bianco

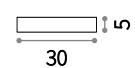

LED 7W / 570 Lm

162089 ■ Bianco









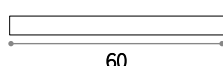

# Cube

Corpoluce dissipatore interamente in lastra d'alluminio da 6 mm di spessore. Rifinito con vernice a polveri. LED integrati.

**LED** Sorgente luminosa LED 3000 K, 25.000 h di durata.

 60 10 5	 30 10 5	 15 10,5 3,5
 IP20	 IP20	 IP20
LED 12W / 1200 Lm	LED 6W / 600 Lm	LED 3W / 240 Lm
161792 ■ Bianco	161785 ■ Bianco	200316 ■ Bianco



# Bright

Corpo luce interamente in alluminio.  
Fascio luminoso orientato sia verso l'alto  
che verso il basso.

**LED** Sorgente luminosa LED 3000 K,  
30.000 h di durata.

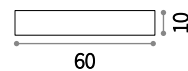

LED 22,44W / 1480 Lm

205137 ■ Alluminio  
131962 ■ Bianco  
205144 ■ Cromo

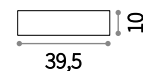

LED 16,8W / 1110 Lm

205175 ■ Alluminio  
134789 ■ Bianco  
205182 ■ Cromo

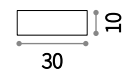

LED 12W / 800 Lm

205151 ■ Alluminio  
134796 ■ Bianco  
205168 ■ Cromo



# Zig Zag

Corpo luce dissipatore interamente in lastra d'alluminio da 6 mm di spessore. Rifinito con vernice a polveri. LED integrati.

**LED** Sorgente luminosa LED 3000 K, 15.000 h di durata.

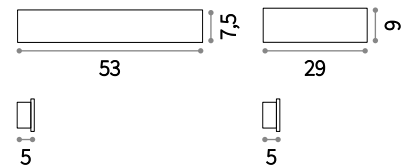

IP20

LED 22W / 2090 Lm

179308 ■ Bianco  
179322 ■ Nero

IP20

LED 12W / 1140 Lm

179292 ■ Bianco  
179315 ■ Nero





# Desk

Corpo luce e rosone in alluminio rifinito con vernice a polveri color bianco opaco.

**LED** Sorgente luminosa LED 3000 K, 30.000 h di durata.

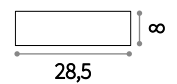

IP20

LED 12W / 1100 Lm

138251 ■ Bianco



# Click

Corpo luce interamente in alluminio verniciato a polveri. Struttura interna che riflette il fascio luminoso sia sopra che sotto.



**LED** Sorgente luminosa LED 3000 K, 20.000 h di durata.

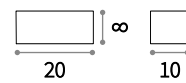

⌀ Ⓧ IP20

LED 12W / 720 Lm

017518 ■ Bianco

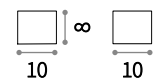

⌀ Ⓧ IP20

LED 6W / 360 Lm

051444 ■ Bianco





# Hot

Corpo luce in metallo con finitura rame, cromo, brunito o vernice opaca di colore bianco o nero.

 Lampadine ALO GU10 28W 2700 K incluse.

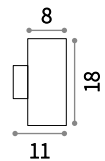

  IP20  INCLUSA

GU10 max 2x28W

- 096018  Bianco
- 164823  Brunito
- 094182  Cromo
- 095998  Nero
- 164847  Rame





# Mouse

Base, montatura e diffusori in metallo rifinito con vernice opaca e dettagli in cromo. Diffusori orientabili.

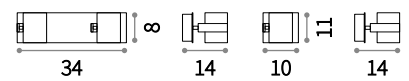

IP20

GU10 max 2 x 50W

073545 ■ Bianco  
156705 ■ Nero

IP20

GU10 max 1 x 50W

073521 ■ Bianco  
073569 ■ Nero



# Spot

Base, montatura e diffusori in metallo rifinito con vernice opaca e dettagli in cromo. Diffusori orientabili.

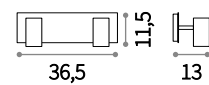

GU10 max 2 x 50W

156736 ■ Bianco  
156743 ■ Nero

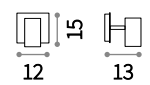

GU10 max 1 x 50W

156729 ■ Bianco  
115481 ■ Nero





# Hydro

Corpo luce interamente in vero cemento  
con supporto metallico interno.

**LED** Lampadine LED R7s 10W 118 mm  
3000 K incluse. Cod. 189093

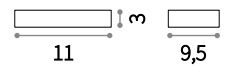

R7s max 1x15W  
139746 ■ Cemento





# Kool

Corpo luce interamente in vero cemento con supporto metallico interno.

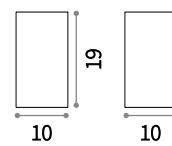

○ □ IP20  
GU10 max 2 x 15W

141275 ■ Cemento

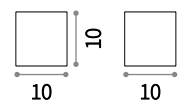

○ □ IP20  
G9 max 1 x 15W

141268 ■ Cemento



# Brick

Corpo luce interamente in metallo rifinito bianco. Emissione luce verso l'alto.



Lampadine ALO G9 28W 2700 K include.

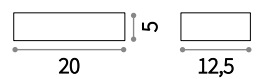

IP20

G9 max 2 x 40W

104355 ■ Bianco

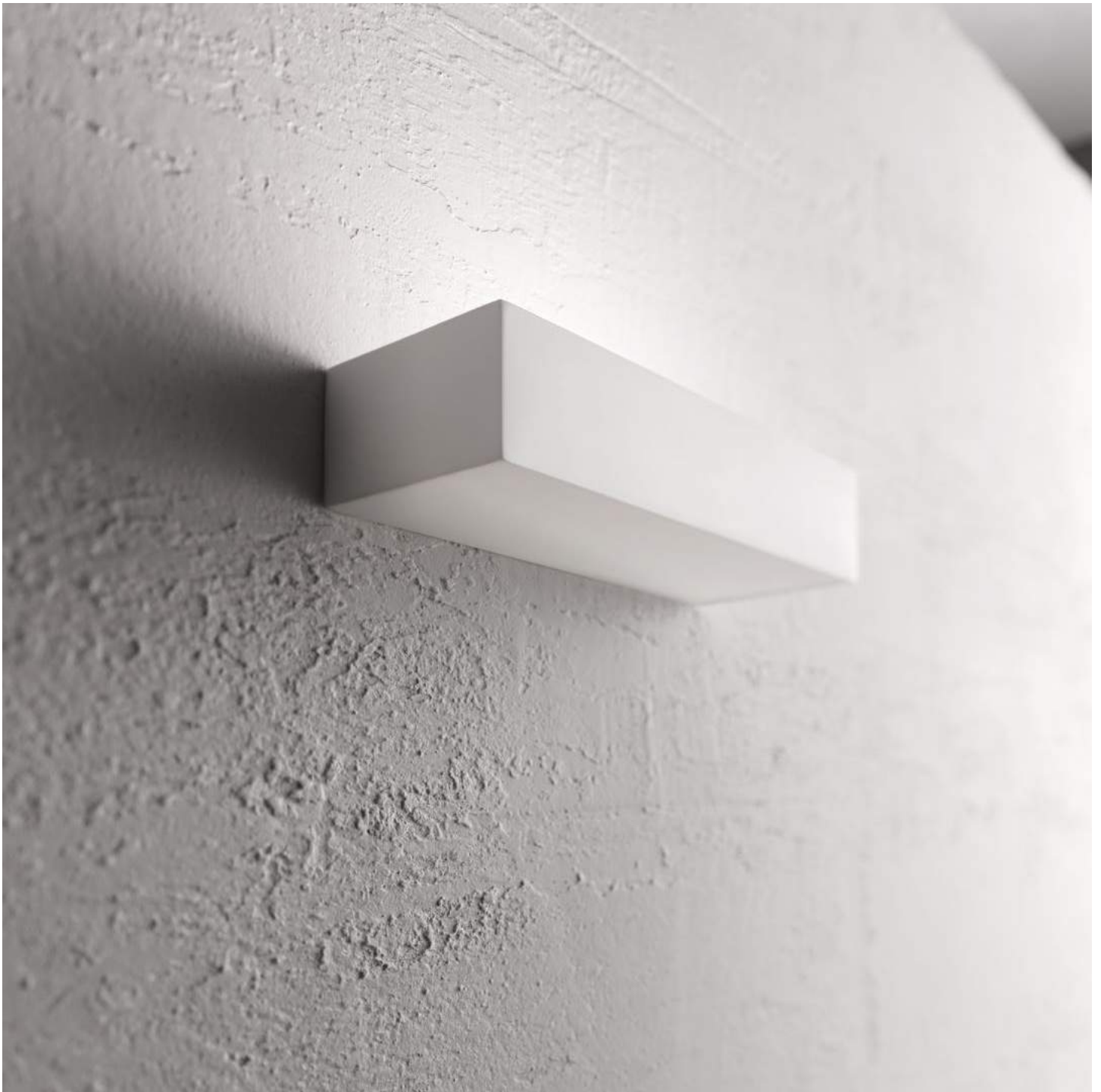

# Matt

Base di fissaggio in metallo verniciato.  
Corpo luce interamente in gesso.  
Emissione luce verso l'alto.

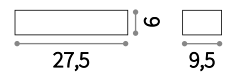

⊕ IP20

E14 max 1x40W

155982 ■ Bianco



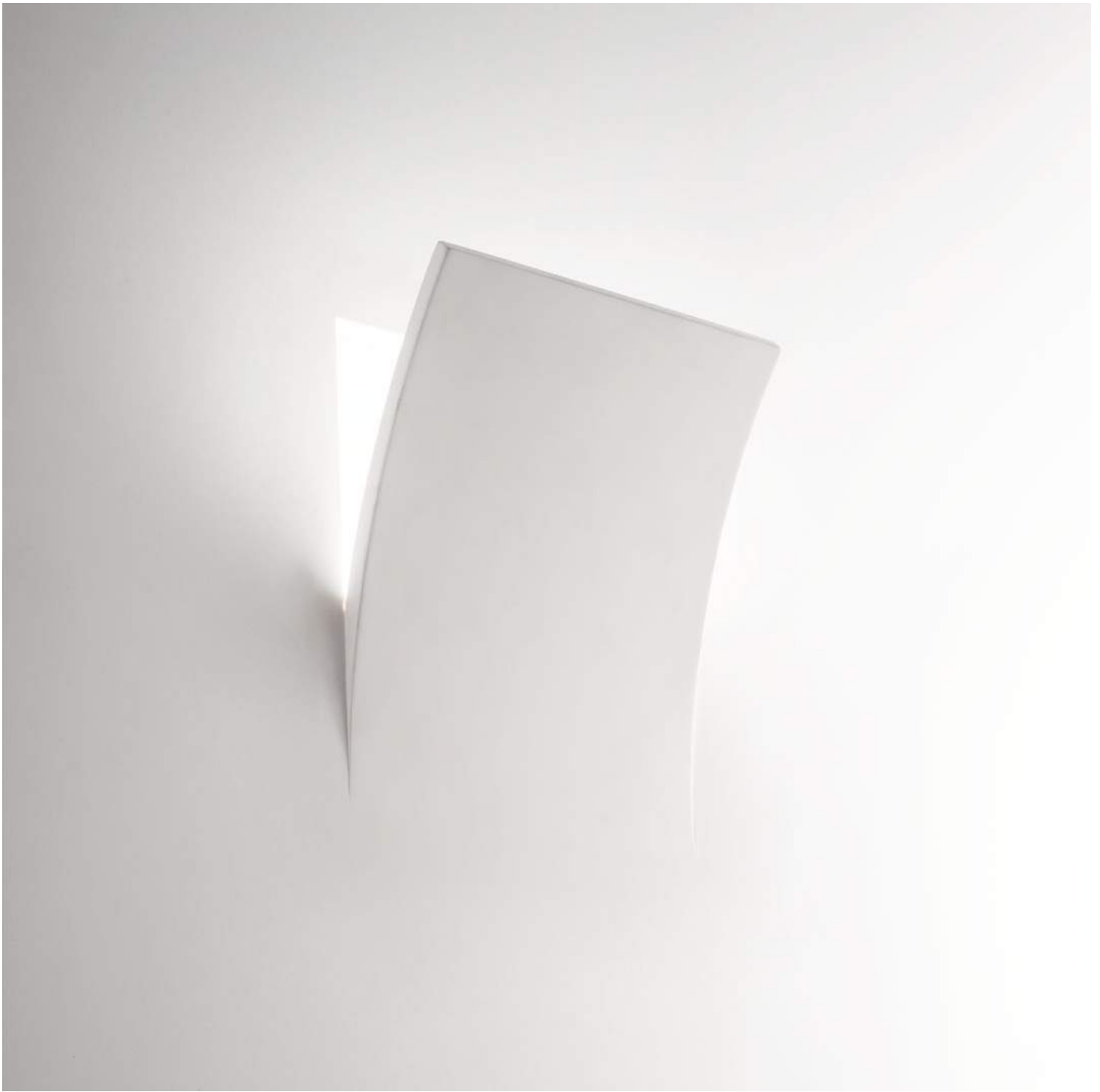

# Foglio

Articolo da incasso per finitura a scomparsa. Corpo luce interamente in gesso. Monta lampadina GU10 sostituibile.

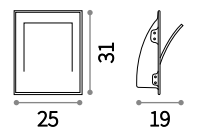

○ ⊕ IP20

E14 max 1 x 40W

150581 ■ Bianco



# Flash Gesso

Base in metallo smaltato. Corpo luce interamente in gesso. Doppia emissione luminosa: sopra e sotto.

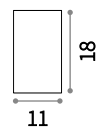

⊕ ⊖ IP20

G9 max 1 x 40W

214689 ■ Bianco

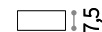
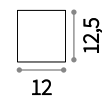

⊕ ⊖ IP20

G9 max 1 x 40W

214672 ■ Bianco

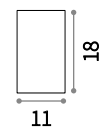

⊕ ⊖ IP20

G9 max 1 x 40W

214696 ■ Bianco

# Gin

Corpo luce in gesso bianco. Base in metallo smaltato bianco. Emissione luce verso l'alto.

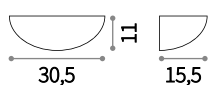

⌀  IP20

E14 max 1 x 40W

105741  Bianco

# Whisky

Corpo luce in gesso bianco. Base in metallo smaltato bianco. Diffusore inferiore in vetro trasparente satinato. Emissione luce sia sopra che sotto.

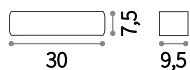

⌀  IP20

E14 max 1 x 40W

105710  Bianco



# Tonic

Corpo luce in gesso bianco. Base in metallo smaltato bianco. Diffusore inferiore in vetro trasparente satinato. Emissione luce sia sopra che sotto.

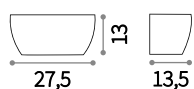

⊕ IP20

E14 max 1 x 40W

105734 ■ Bianco



# Soda

Corpo luce in gesso bianco. Base in metallo smaltato bianco. Diffusore inferiore in vetro trasparente satinato. Emissione luce sia sopra che sotto.



⊕ IP20

E14 max 2 x 40W

105727 ■ Bianco



# Sospensioni











# Oracle

Rosone e corpo luce in alluminio verniciato a polveri. Diffusore in materiale plastico color opale. Sorgente luminosa a led integrati.

**LED** Sorgente luminosa LED 3000 K, 20.000 h di durata.

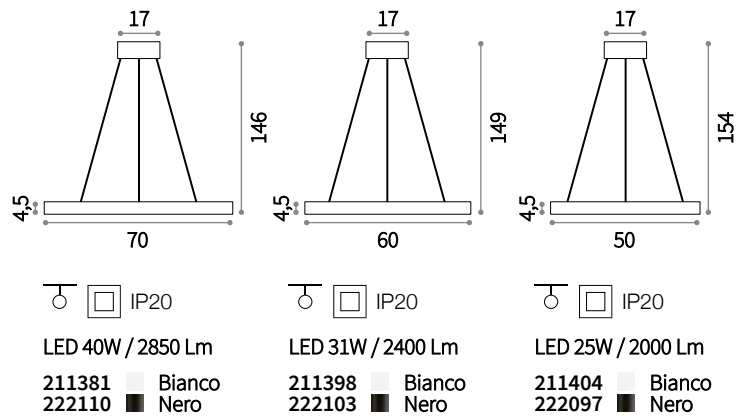





# Halo

Base e corpo luce in alluminio verniciato a polveri. Diffusore in materiale plastico color opale. Sorgente luminosa a led integrati.

**LED** Sorgente luminosa LED 3000/4000 K, 35.000 h di durata.

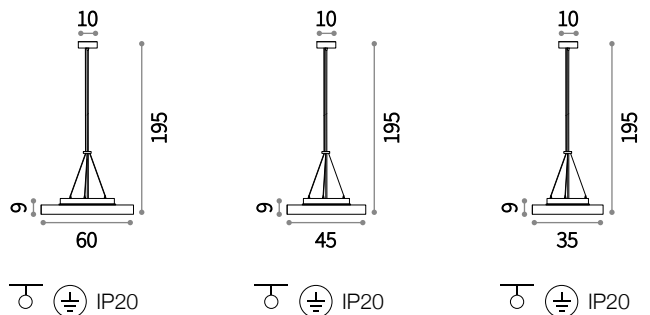

LED 34W / 4300/5000 Lm    LED 21,5W / 2800/3200 Lm    LED 17,2W / 2200/2500 Lm

226743    Bianco 3000 K    226729    Bianco 3000 K    226712    Bianco 3000 K  
 226750    Bianco 4000 K    226736    Bianco 4000 K    223254    Bianco 4000 K





# Stadium

Montatura in metallo rifinito con vernice opaca. Cavi regolabili in lunghezza. Diffusore acrilico. LED integrati.

**LED** Sorgente luminosa LED 3000 K, 20.000 h di durata.

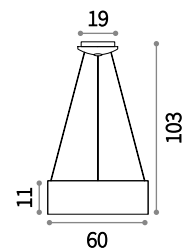

⊕ ⊖ IP20

LED 36W / 2160 Lm

153124 ■ Bianco

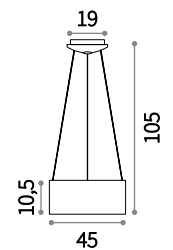

⊕ ⊖ IP20

LED 28W / 1680 Lm

157030 ■ Bianco



# Polo

Rosone e montatura in metallo verniciato bianco opaco. Diffusore in policarbonato bianco opaco. Sospensioni con cavi in acciaio regolabili in lunghezza da dispositivi automatici.

**LED** Sorgente luminosa LED 3000 K, 30.000 h di durata.

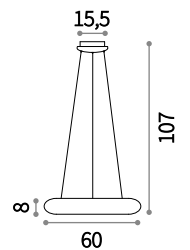

⏏ Ⓢ IP20

LED 40W / 3850 Lm

140520 ■ Bianco



# Ufo

Montatura in metallo verniciato bianco opaco. Diffusore in materiale plastico bianco satinato con LED integrati.

**LED** Sorgente luminosa LED 3000 K, 30.000 h di durata.

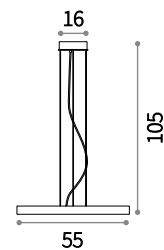

⊕ ⊖ IP20

LED 50W / 3500 Lm

103709 ■ Bianco

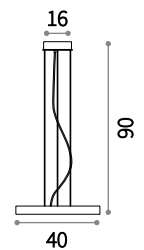

⊕ ⊖ IP20

LED 36W / 2500 Lm

103693 ■ Bianco



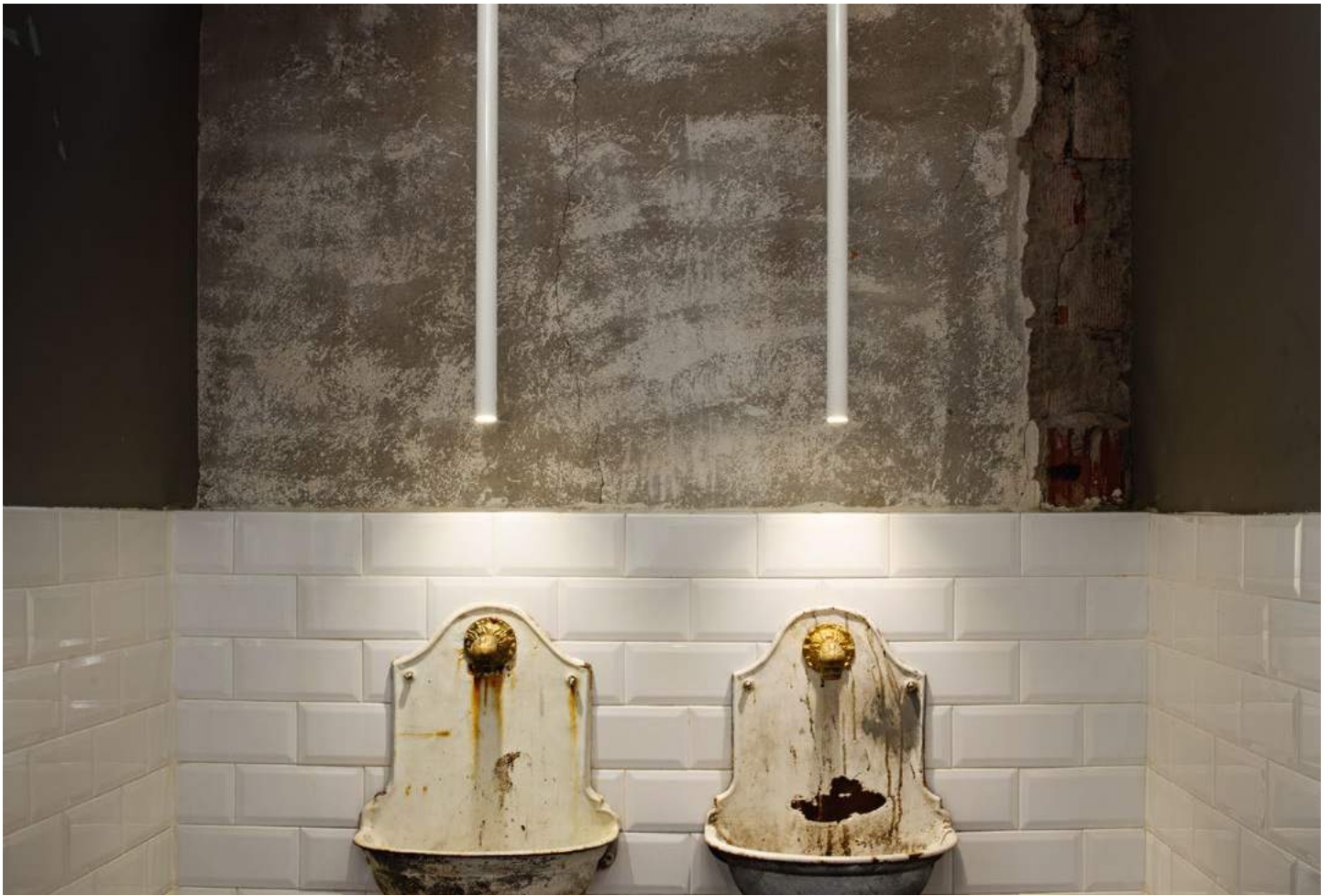

# Ultrathin

Rosone e diffusore in metallo con finitura cromo o in vernice opaca bianca o nera.

**LED** Sorgente luminosa LED 3000 K, 30.000 h di durata.

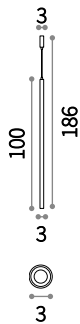

LED 12W / 760 Lm

142906 Bianco  
164878 Cromo  
142913 Nero

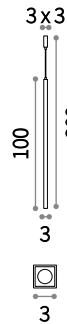

LED 12W / 760 Lm

194172 Bianco  
194196 Nero

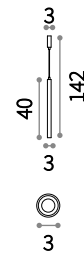

LED 12W / 760 Lm

156682 Bianco  
187662 Cromo  
156699 Nero



LED 12W / 760 Lm

194189 Bianco  
194202 Nero



# Tube

Rosone e corpo luce in alluminio verniciato a polveri. Cavo in tessuto. Sorgente luminosa a led integrati.

**LED** Sorgente luminosa LED 3000 K, 35.000 h di durata.



Optional  
 223889 Ø 4 cm  
 223896 Ø 6 cm  
 223902 Ø 9 cm

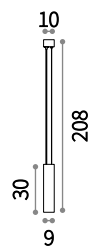

IP20

LED 13,8W / 1300 Lm

211749 ■ Bianco  
 211756 ■ Nero

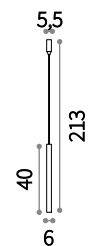

IP20

LED 9,3W / 1000 Lm

211701 ■ Bianco  
 211718 ■ Nero

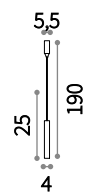

IP20

LED 8,9W / 850 Lm

211459 ■ Bianco  
 211466 ■ Nero





# Oak

Corpo luce in gesso o cemento. Cavo in tessuto nero.

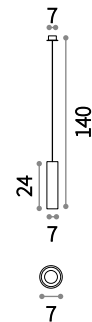

GU10 max 1 x 35W

150628 ■ Bianco  
150635 ■ Cemento

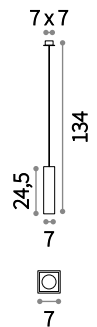

GU10 max 1 x 35W

150666 ■ Bianco  
150673 ■ Cemento





# Kool

Rosone in metallo verniciato nero opaco. Cavo in tessuto nero. Diffusore in cemento.

**LED**

Lampadine LED G9 3,2W e LED GU10 7W 3000 K incluse.  
Cod. 209043/101378

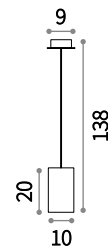

GU10 max 1 x 28W

201177 ■ Cemento

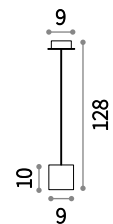

G9 max 1 x 28W

201160 ■ Cemento



# Garage

Montatura in alluminio verniciato a polveri. Diffusore orientabile con schermo in vetro trasparente. Led integrati.

**LED** Sorgente luminosa LED 3000 K, 50.000 h di durata.

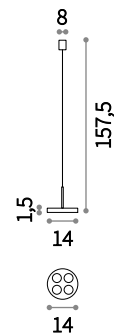

LED 12W / 1080 Lm

205847 ■ Bianco  
205854 ■ Nero

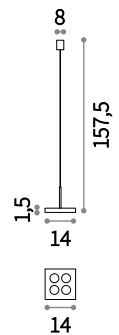

LED 12W / 1080 Lm

205823 ■ Bianco  
205830 ■ Nero







# Desk

Corpo luce e rosone in alluminio rifinito con vernice a polveri color bianco opaco. Sospensione con cavi elettrici regolabili in lunghezza.

**LED** Sorgente luminosa LED 3000 K, 30.000 h di durata.

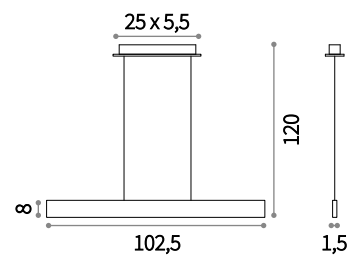

⊕ ⊖ IP20

LED 23W / 2100 Lm

138237 ■ Bianco



# Club

Corpo luce e rosone in alluminio o verniciato in bianco opaco. Cavi in acciaio regolabili in lunghezza da dispositivi automatici.

**LED** Sorgente luminosa LED 3000 K, 30.000 h di durata.

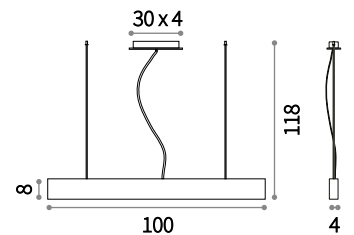

IP20

LED 23,52W / 1440 Lm

137995 ■ Alluminio  
138008 ■ Bianco

# Esterno

## Tavolo e terra









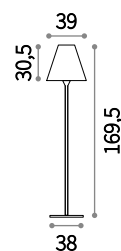

# Itaca

Base e stelo in metallo verniciato a polveri. Diffusore conico in materiale plastico color opale. Fornito con spina.

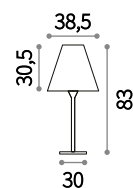

  IP44  
E27 max 1 x 60W  
180953 ■ Bianco



  IP44  
E27 max 1 x 60W  
180960 ■ Bianco









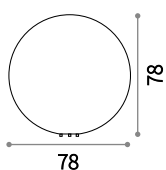

# Doris

Diffusore in materiale plastico grigio melange effetto granito. Fornito con spina e picchetto per fissaggio nel terreno.



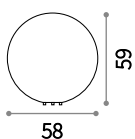

  IP44  
E27 max 1x60W  
195506 ■ Bianco



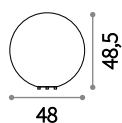

  IP44  
E27 max 1x60W  
195490 ■ Bianco



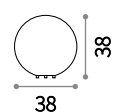

  IP44  
E27 max 1x60W  
195483 ■ Bianco

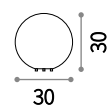

  IP44  
E27 max 1x60W  
195476 ■ Bianco



  IP44  
E27 max 1x60W  
214009 ■ Bianco





# Sole

Diffusore in materiale plastico opale.  
Fornito con spina e picchetto per terreno.  
Base sospensione in alluminio. Anche in  
versione da parete.

**LED** Lampadine LED G9 3,2W 4000 K  
incluse nel modello 213316.  
Cod. 209036

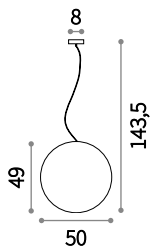

IP44  
E27 max 1 x 60W  
136011 ■ Bianco

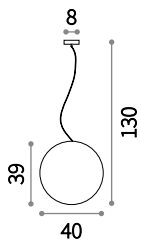

IP44  
E27 max 1 x 60W  
136004 ■ Bianco

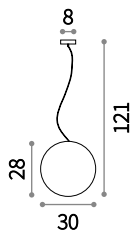

IP44  
E27 max 1 x 60W  
135991 ■ Bianco

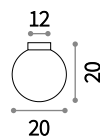

IP44  
E27 max 1 x 42W  
213309 ■ Bianco

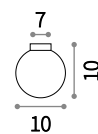

IP44  
G9 max 1 x 15W  
213316 ■ Bianco

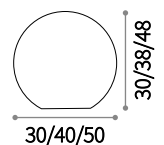

IP44  
E27 max 1 x 60W  
191638 ■ Bianco ø 30  
191621 ■ Bianco ø 40  
191614 ■ Bianco ø 50







# Luna

Diffusore in materiale plastico opale.  
Fornito con spina e picchetto per terreno.  
Anche in versione da parete.



Lampadine LED G9 3,2W 4000 K  
incluse nel modello 213200.  
Cod. 209036

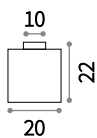



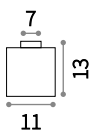

 IP44  
 E27 max 1x42W  
 213194 ■ Bianco





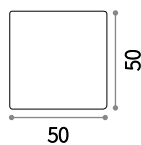

 IP44
  INCLUSA  
 G9 max 1x5W  
 213200 ■ Bianco



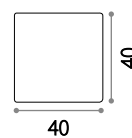

 IP44  
 E27 max 1x60W  
 191607 ■ Bianco

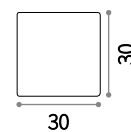

 IP44  
 E27 max 1x60W  
 191584 ■ Bianco



 IP44  
 E27 max 1x60W  
 191577 ■ Bianco











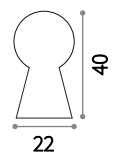

## Birillo Outdoor

Corpo luce-diffusore in materiale plastico di colore bianco opaco. Fornito completo di cavo e spina.



  IP44  
E27 max 1x60W  
131955  Bianco







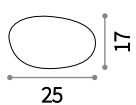

# Sasso

Diffusore in materiale plastico opale.  
Fornito di cavo con spina e picchetto per fissaggio a terra. Disponibile in versione da parete.



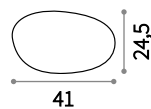



 IP44  
 G9 max 1x15W  
 213590 ■ Bianco

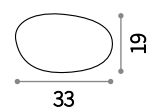



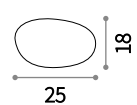

 IP44  
 E27 max 1x40W  
 161778 ■ Bianco





 IP44  
 E27 max 1x40W  
 161761 ■ Bianco



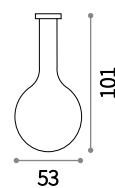

 IP44  
 G9 max 1x15W  
 161754 ■ Bianco

# Jar

Corpo luce-diffusore in materiale plastico di colore bianco opaco. Fornito completo di cavo e spina.



♀ □ IP44

E27 max 1 x 42W

205946 ■ Bianco

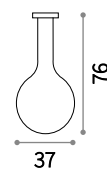

♀ □ IP44

E27 max 2 x 42W

205939 ■ Bianco







# Live

Apparecchio mobile senza cavi, con led alimentati da batterie ricaricabili e luce a variazione di colore regolabile RGB. Corpo luce-diffusore in policarbonato bianco opaco. Autonomia batterie di 10 ore.

**LED** Sorgente luminosa LED 4000 K, 15.000 h di durata.

**ON**  
**OFF** Lampada con interruttore integrato.

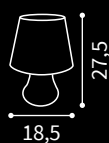

○ ○ ◊ IP65  
LED 2,5W / 10 Lm  
**138886** ■ Bianco



○ ○ ◊ IP65  
LED 2,5W / 10 Lm  
**138893** ■ Bianco

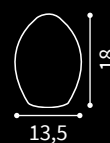

○ ○ ◊ IP65  
LED 2,5W / 10 Lm  
**138879** ■ Bianco

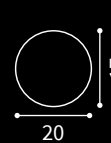

○ ○ ◊ IP65  
LED 2,5W / 10 Lm  
**138800** ■ Bianco



138893







# Armony

Montatura in alluminio pressofuso e tornito, rifinito con vernici a polveri.  
Diffusore in materiale plastico bianco opaco.

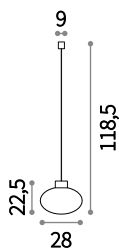

E27 max 1 x 60W

- 149486 ■ Antracite
- 148922 ■ Bianco
- 149509 ■ Grigio
- 149493 ■ Nero

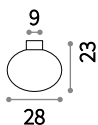

E27 max 1 x 60W

- 149455 ■ Antracite
- 144221 ■ Bianco
- 149479 ■ Grigio
- 149462 ■ Nero

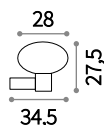

E27 max 1 x 60W

- 147291 ■ Antracite
- 136172 ■ Bianco
- 147314 ■ Grigio
- 147307 ■ Nero

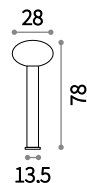

E27 max 1 x 60W

- 147352 ■ Antracite
- 136141 ■ Bianco
- 147376 ■ Grigio
- 147369 ■ Nero

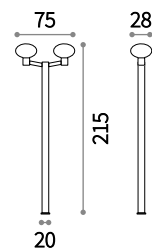

E27 max 2 x 60W

- 147383 ■ Antracite
- 136158 ■ Bianco
- 147390 ■ Grigio
- 145112 ■ Nero





# Sound

Montatura in alluminio pressofuso e tornito, rifinito con vernici a polveri.  
Diffusore in materiale plastico bianco opaco.

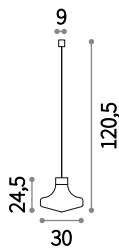

IP44

E27 max 1 x 60W

- 150048 ■ Antracite
- 150055 ■ Bianco
- 150062 ■ Grigio
- 150079 ■ Nero

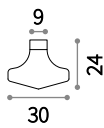

IP44

E27 max 1 x 60W

- 150017 ■ Antracite
- 150024 ■ Bianco
- 144191 ■ Grigio
- 150031 ■ Nero

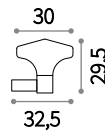

IP44

E27 max 1 x 60W

- 146553 ■ Antracite
- 146560 ■ Bianco
- 136226 ■ Grigio
- 146546 ■ Nero

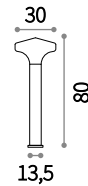

IP44

E27 max 1 x 60W

- 146836 ■ Antracite
- 146843 ■ Bianco
- 136189 ■ Grigio
- 146850 ■ Nero

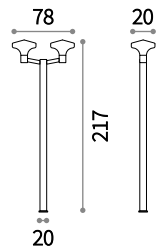

IP44

E27 max 2 x 60W

- 146874 ■ Antracite
- 146867 ■ Bianco
- 136202 ■ Grigio
- 146881 ■ Nero







# Concerto

Montatura in alluminio pressofuso e tornito, rifinito con vernici a polveri.  
Diffusore in materiale plastico bianco opaco.

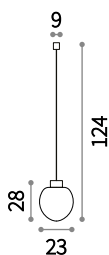

E27 max 1 x 60W

- 149974 ■ Antracite
- 149981 ■ Bianco
- 149998 ■ Grigio
- 150000 ■ Nero

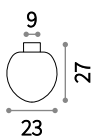

E27 max 1 x 60W

- 149943 ■ Antracite
- 149950 ■ Bianco
- 149967 ■ Grigio
- 144214 ■ Nero

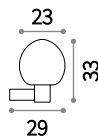

E27 max 1 x 60W

- 146669 ■ Antracite
- 146645 ■ Bianco
- 146652 ■ Grigio
- 136127 ■ Nero

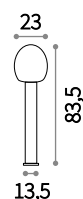

E27 max 1 x 60W

- 147260 ■ Antracite
- 147277 ■ Bianco
- 147284 ■ Grigio
- 136097 ■ Nero

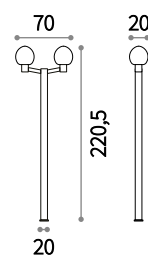

E27 max 2 x 60W

- 147208 ■ Antracite
- 147215 ■ Bianco
- 147222 ■ Grigio
- 136103 ■ Nero







# Fiesta

Cavo con portalampane e occhielli di ancoraggio in materiale plastico. Fornito con spina per esterni.

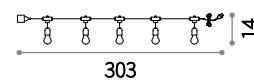

IP44

E27 max 5x 15W

218724 ■ Bianco  
159836 ■ Nero









# Classic Globe

Corpo luce in resina resistente a corrosione, UV, a temperature da -60°a +90° C. Diffusore anti ingiallimento.

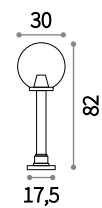
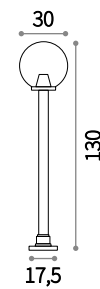

♀ □ IP44  
E27 max 1 x 60W

♀ □ IP44  
E27 max 1 x 60W

187525 □ Bianco  
187532 ▨ Trasparente

187549 □ Bianco  
187556 ▨ Trasparente





# Green

Corpo luce in fusione di alluminio verniciato a polveri. Diffusore in policarbonato bianco.

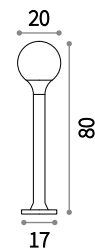

♀ ⚡ IP44  
E27 max 1 x 60W  
135786 ■ Bianco

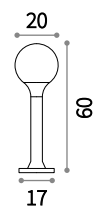



♀ ⚡ IP44  
E27 max 1 x 60W  
139579 ■ Bianco

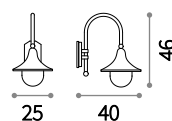

# Cima

Corpo luce interamente in alluminio pressofuso. Con finitura nero e oro. Diffusore in acrilico trasparente.



⌀  IP43  
E27 max 1 x 60W

024134 ■ Nero Antico

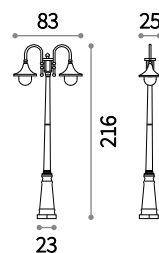

♀  IP43  
E27 max 2 x 60W

024097 ■ Nero Antico



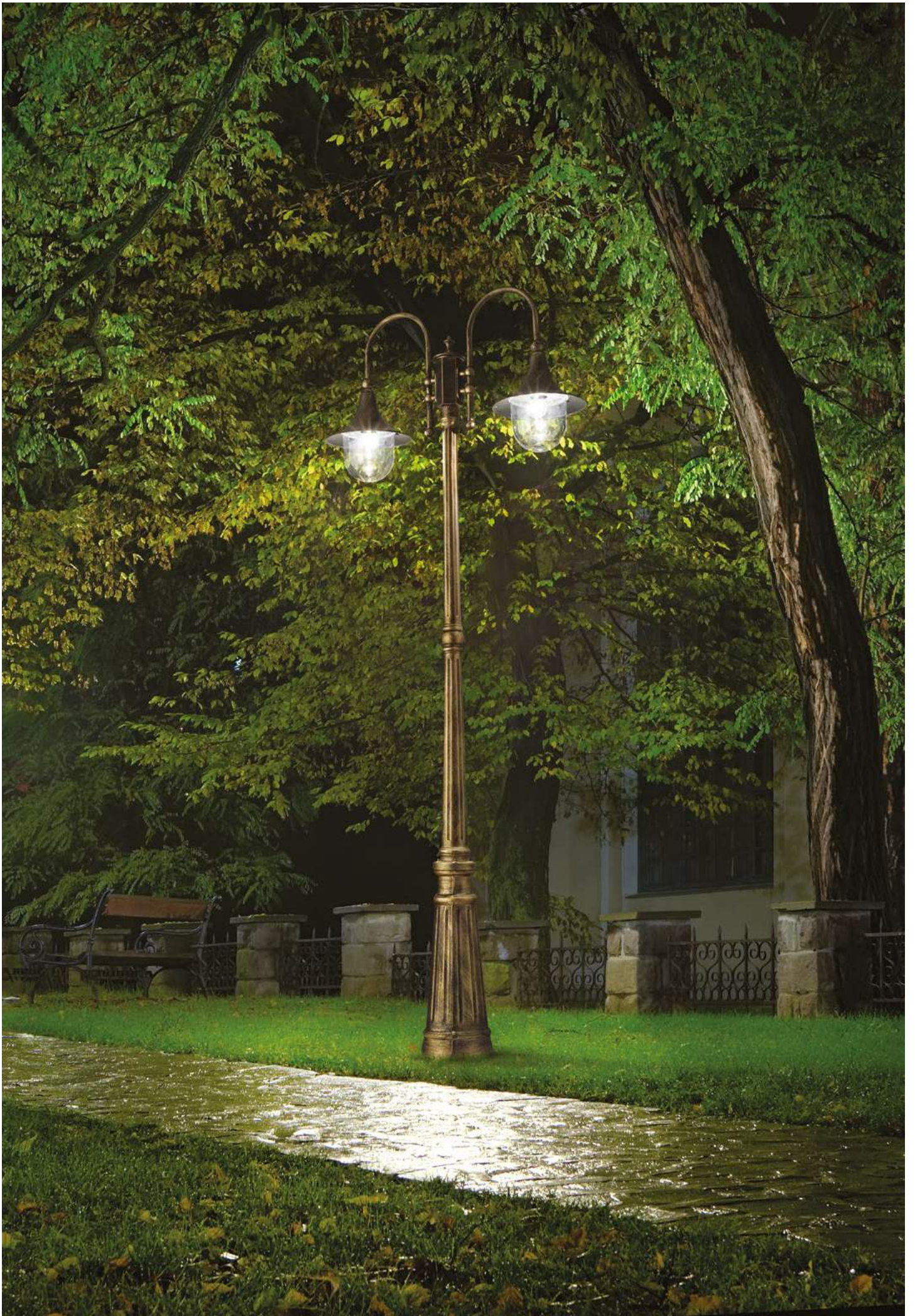





# Anna

Corpo luce in resina ad alte prestazioni:  
 inattaccabile dalla corrosione, colori  
 stabilizzati da trattamento U.V., resistente  
 a sbalzi termici da -60° C a +90° C.  
 Diffusore in metacrilato antingiallimento.

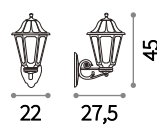

E27 max 1x60W

120423 ■ Bianco  
 101491 ■ Nero

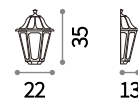

max 1x60W E27

120430 ■ Bianco  
 101552 ■ Nero

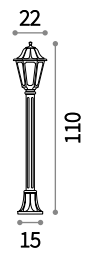

E27 max 1x60W

120454 ■ Bianco  
 101514 ■ Nero





# Tesla

Corpo luce in alluminio verniciato a polveri. Diffusore con schermo in materiale plastico bianco. Emissione luce verso il basso.

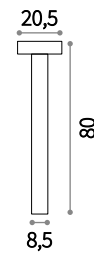

♀ ⚡ IP44  
G9 max 4 x 15W

153162 ■ Antracite  
153179 ■ Bianco

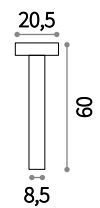

♀ ⚡ IP44  
G9 max 4 x 15W

153193 ■ Antracite  
153209 ■ Bianco







# Snoopy

Corpo luce in alluminio verniciato a polveri. Diffusore con schermo in vetro trasparente. LED integrato.

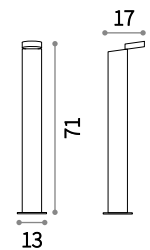
**LED** Sorgente luminosa LED 4000 K, 25.000 h di durata.





 IP44  
 LED 7W / 720 Lm  
 161457 ■ Antracite



# Amelia

Corpo luce e diffusore in resina ad alte prestazioni: anti corrosione, colori stabilizzati da trattamento U.V., resistente da -60° C a +90° C.

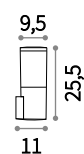
**LED** Lampadine LED E27 8W Sfera 4000 K incluse.



E27 max 1 x 8W

221939  Bianco  
 221953  Grigio  
 221946  Nero

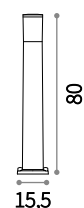

E27 max 1 x 23W

198644  Bianco  
 198637  Grigio  
 198620  Nero







# Style

Corpo luce in alluminio verniciato a polveri. Diffusore in materiale plastico opale. Sorgente luminosa a led integrato. Modello AP Sensor dotato di sensore PIR.

**LED** Sorgente luminosa LED 4000 K, 30.000 h di durata.

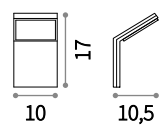

○ ⊕ IP54

LED 9W / 680 Lm

209845 ■ Antracite  
221502 ■ Bianco

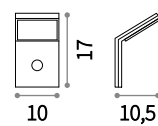

○ ⊕ IP54

LED 9,5W / 680 Lm

221519 ■ Antracite  
209852 ■ Bianco

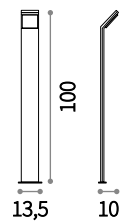

♀ ⊕ IP54

LED 9W / 680 Lm

209906 ■ Antracite  
209913 ■ Bianco





# Tronco

Corpo luce in alluminio pressofuso rifinito in vernice con varie finiture. Diffusore in vetro pirex con elementi interni in alluminio.

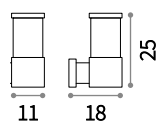

IP44

E27 max 1 x 60W

027005 ■ Antracite  
118659 ■ Bianco  
026978 ■ Grigio  
004716 ■ Nero

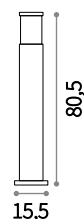

IP44

E27 max 1 x 60W

026992 ■ Antracite  
109138 ■ Bianco  
163741 ■ Coffee  
026961 ■ Grigio  
004723 ■ Nero

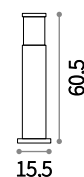

IP44

E27 max 1 x 60W

026985 ■ Antracite  
109145 ■ Bianco  
163758 ■ Coffee  
026954 ■ Grigio  
004730 ■ Nero







# Torre

Corpo luce in alluminio tornito verniciato a polveri con finitura opaca. Diffusore in materiale plastico opale.

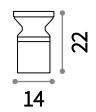

♀ ⚡ IP44

E27 max 1 x 15W

162492 ■ Antracite  
186948 ■ Bianco  
186955 ■ Nero

♀ ⚡ IP44

E27 max 1 x 15W

158891 ■ Antracite  
186962 ■ Bianco  
186979 ■ Nero



# Neos

Corpo luce in alluminio tornito verniciato a polveri. Diffusore inclinabile con vetro trasparente.

**LED** Sorgente luminosa LED 4000 K, 25.000 h di durata.

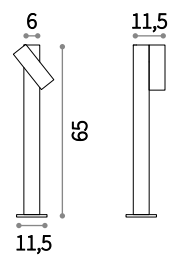

♀ Ⓢ IP44

LED 9,5W / 720 Lm

161907 ■ Antracite  
161921 ■ Nero





# Pulsar

Montatura in fusione d'alluminio verniciato a polveri in vari colori. Diffusore in policarbonato bianco.

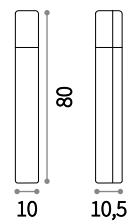

⊕ ⊖ IP44

E27 max 1x 42W

135908 ■ Antracite  
135922 ■ Grigio



# Venus

Corpo luce in lamina d'acciaio disponibile con finitura spazzolata o antracite. Elemento diffusore superiore in acrilico satinato.

**LED** Lampadine LED GU10 7W 4000 K incluse. Cod. 117652

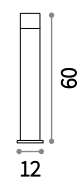
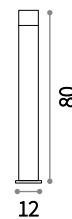

GU10 max 1 x 15W

089775 ■ Acciaio  
106175 ■ Antracite



GU10 max 1 x 15W

010892 ■ Acciaio  
106182 ■ Antracite



# Gas

Corpo luce in alluminio pressofuso verniciato a polveri. Diffusore in vetro temperato trasparente sabbiato.

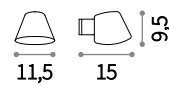

IP43

GU10 max 1 x 28W

- 091525 ■ Antracite
- 091518 ■ Bianco
- 020228 ■ Nero

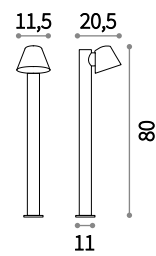

IP43

GU10 max 1 x 35W

- 139470 ■ Antracite









# Polaris

Corpo luce in alluminio verniciato a polveri. Diffusore in vetro pirex trasparente.

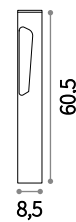

♀ Ⓢ IP44

G9 max 1 x 15W

115122 ■ Antracite



# Acqua

Corpo luce in alluminio tornito rifinito in vernice opaca, disponibile nei colori antracite o bianco. Diffusore in vetro temperato.

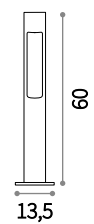

♀ Ⓢ IP44

G9 max 1 x 15W

135205 ■ Antracite  
135212 ■ Bianco



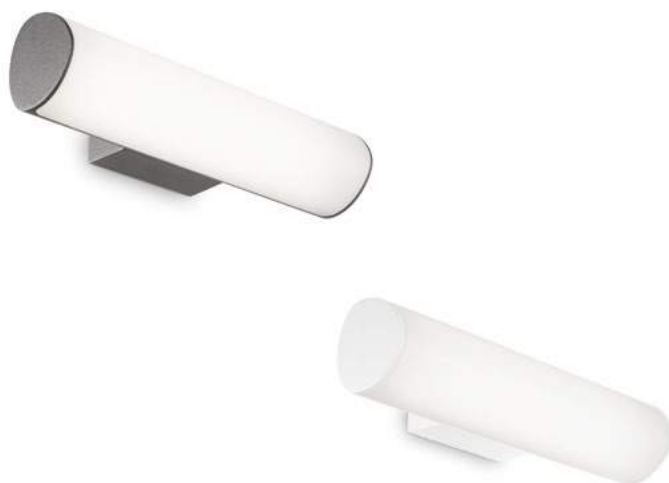

# Etere

Corpo luce in fusione di alluminio verniciato a polveri. Diffusore in materiale plastico color opale.

**LED** Sorgente luminosa LED 4000 K, 25.000 h di durata.

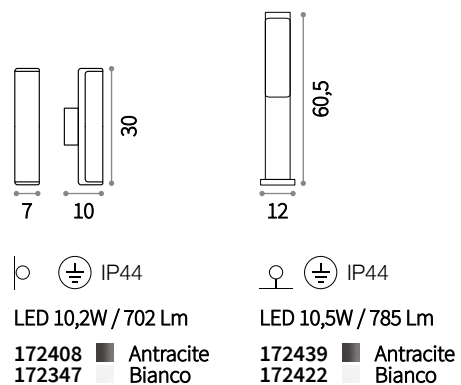



# Edo Outdoor

Montatura in fusione d'alluminio verniciato a polveri in vari colori. Diffusore in policarbonato bianco.

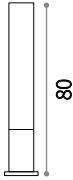

15,5



15,5

⌀ Ⓧ IP44

GX53 max 1 x 15W

138510 ■ Antracite  
135755 ■ Bianco

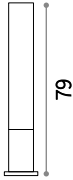

15



15

⌀ Ⓧ IP44

GX53 max 1 x 15W

135762 ■ Antracite  
142999 ■ Bianco







# Sirio

Corpo luce in alluminio verniciato a polveri. Diffusore in vetro pirex trasparente.



♀ ⚡ IP44

G9 max 2 x 15W

115061 ■ Antracite  
115085 ■ Bianco  
213262 ■ Coffee  
115108 ■ Nero

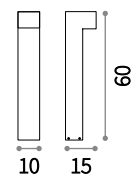

♀ ⚡ IP44

G9 max 2 x 15W

115078 ■ Antracite  
115092 ■ Bianco  
213279 ■ Coffee  
115115 ■ Nero





# Titano

Corpoluce in resina porosa. Base e dettaglio diffusore in metallo verniciato nero opaco. Emissione luce verso il basso. LED integrato.

**LED** Sorgente luminosa LED 4000 K, 25.000 h di durata.

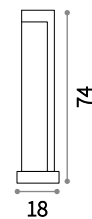

♀ □ IP55

LED 7W / 450 Lm

187327 ■ Granito

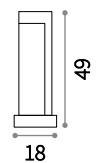

♀ □ IP55

LED 7W / 450 Lm

157856 ■ Granito



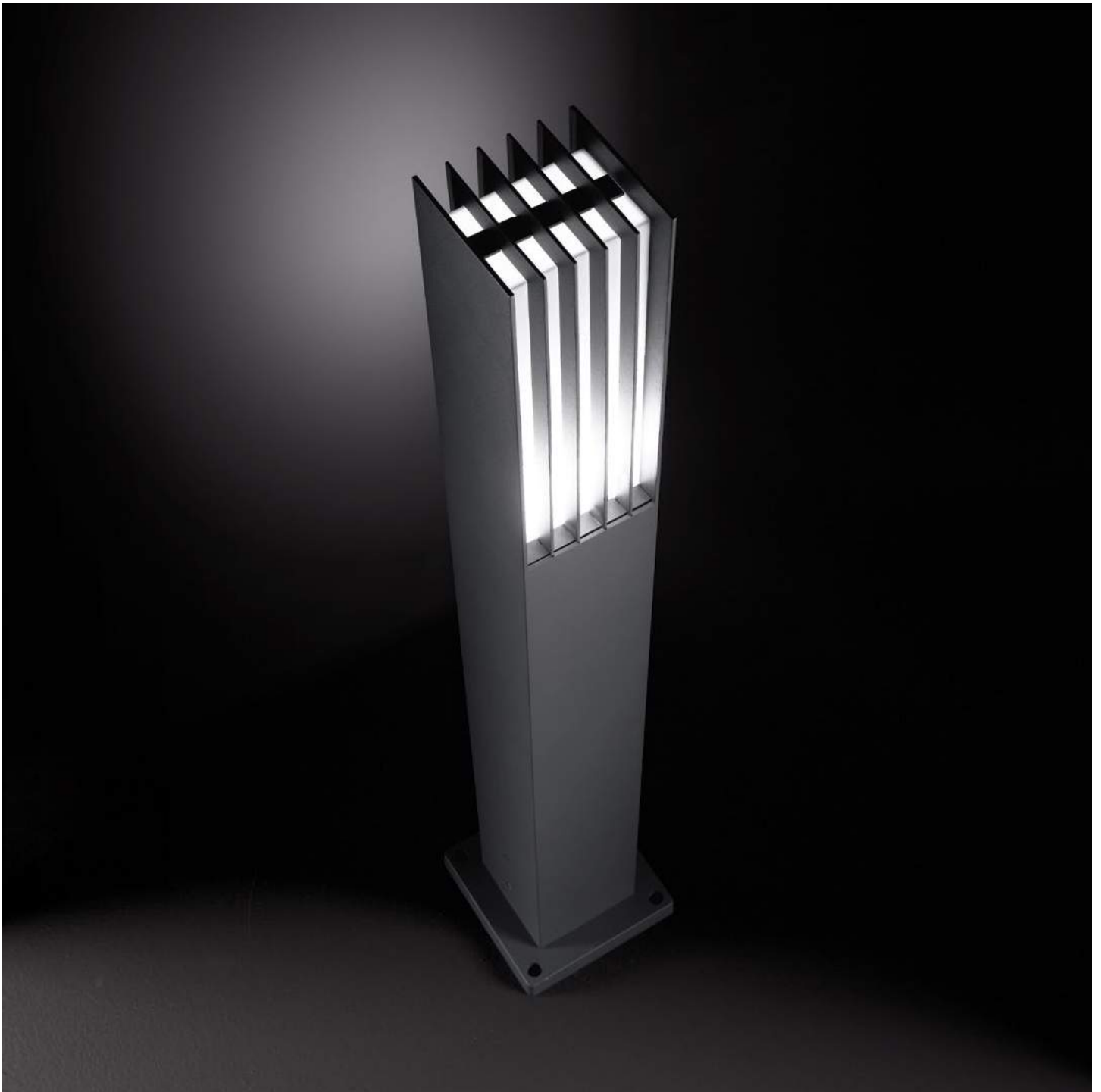

# Marte

Corpo luce in alluminio verniciato a polveri. Diffusore bianco in materiale acrilico.

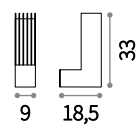

⌀ Ⓧ IP44

E27 max 1 x 25W

135854 ■ Antracite

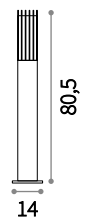

⌀ Ⓧ IP44

E27 max 1 x 25W

092225 ■ Antracite



# Hole

Base in metallo nero opaco. Corpo luce in mescola di resina con effetto granito. Sorgente luminosa a led integrati.

**LED** Sorgente luminosa LED 4000 K, 25.000 h di durata.

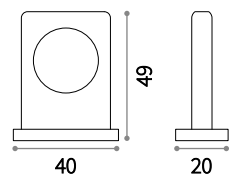

♀ □ IP55

LED 7W / 510 Lm

212760 ■ Granito

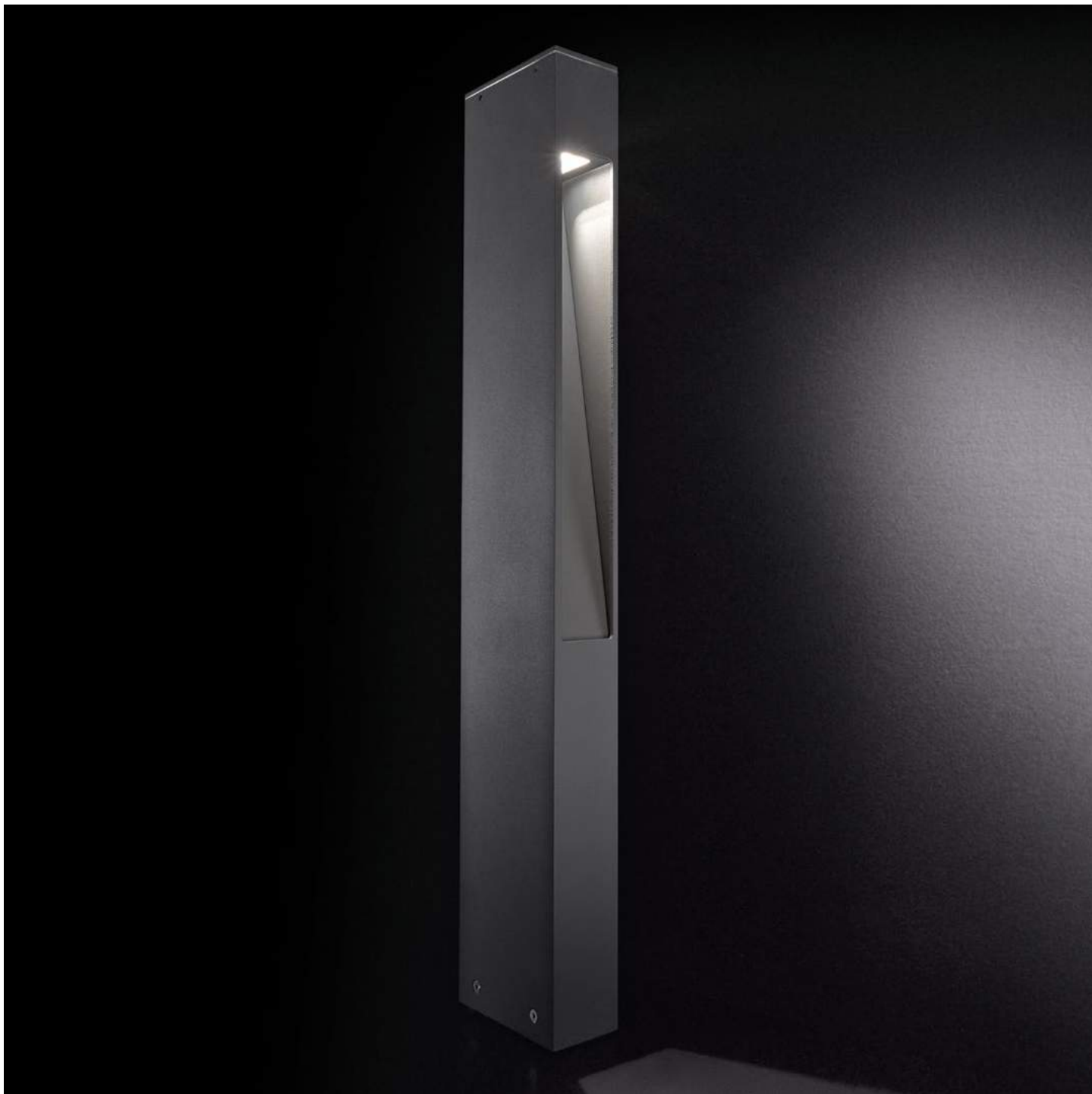

# Mercurio

Corpo luce in alluminio verniciato a polveri. Diffusore in vetro pirex trasparente.

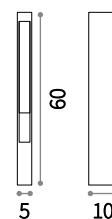

⊕ ⊖ IP44

G9 max 1 x 15W

114347 ■ Antracite





# Vega

Corpo luce in alluminio con finitura in vernice opaca a polveri. Diffusore in vetro temperato trasparente.

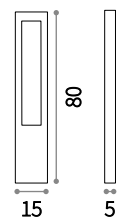

⊕ IP44

G9 max 1 x 15W

136028 ■ Antracite  
 136035 ■ Bianco  
 136042 ■ Grigio  
 136059 ■ Nero



# Elisa

Corpo luce in resina resistente a corrosione, UV, a temperature da -60°a +90° C. Diffusore trasparente anti ingiallimento.

**LED** Lampadine LED GX53 3W e LED GX53 7W 4000 K incluse.

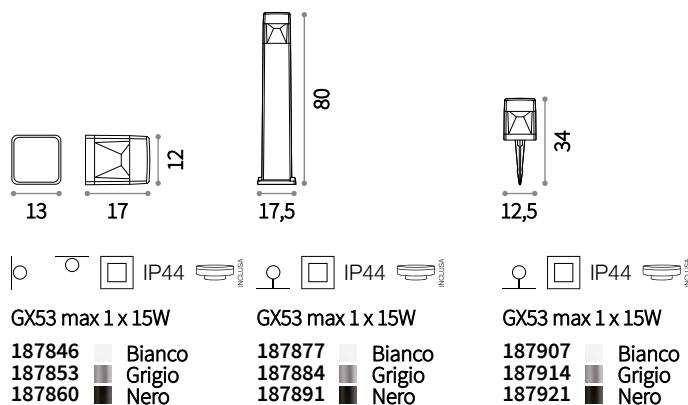









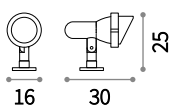

# Terra

Montatura in fusione d'alluminio verniciata. Corpo luce posizionabile. Diffusore in vetro pirex trasparente. Disponibile con base a muro o a lancia da interrare.



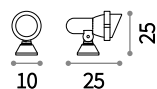

 IP65  
 E27 max 1 x 60W  
 046167 ■ Antracite



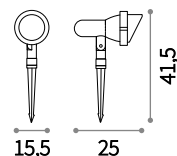

 IP65  
 GU10 max 1 x 35W  
 046181 ■ Antracite

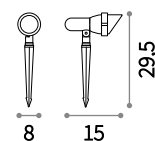

 IP65  
 E27 max 1 x 60W  
 033044 ■ Antracite



 IP65  
 GU10 max 1 x 35W  
 033037 ■ Antracite  
 106205 ■ Bianco  
 163727 ■ Coffee  
 046211 ■ Nero







# Tommy

Corpo luce e diffusore in resina ad alte prestazioni: inattaccabile dalla corrosione sia di agenti atmosferici sia di fertilizzanti chimici; colori stabilizzati da trattamento U.V.. Resistente a sbalzi termici da -60° C a +90° C. Diffusore direzionabile.

**LED** Lampadine LED GX53 7W 4000 K incluse.

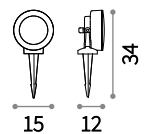
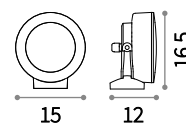

GX53 max 1 x 7W

GX53 max 1 x 7W

145303  Bianco  
145327  Grigio  
145341  Nero

145310  Bianco  
145334  Grigio  
145358  Nero





# Minitommy

Corpo luce e diffusore in resina ad alte prestazioni: inattaccabile dalla corrosione sia di agenti atmosferici che di fertilizzanti chimici, colori stabilizzati da trattamento U.V., resistente a sbalzi termici da -60° C a +90° C. Diffusore direzionabile.

**LED** Lampadine LED GU10 3,5W 4000 K incluse.

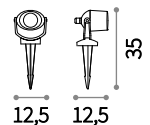
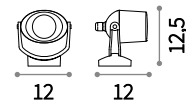

GU10 max 1 x 4,5W

GU10 max 1 x 4,5W

096483  Bianco  
096476  Nero

120218  Bianco  
120201  Nero



# Zenith

Montatura in fusione d'alluminio verniciata a polveri. Corpo luce posizionabile. Diffusore in materiale plastico.

**LED** Lampadine LED GU10 7W 4000 K incluse. Cod. 117652

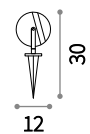
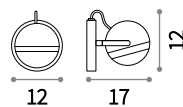

IP54

IP65

IP65

GU10 max 1 x 11W

GU10 max 1 x 11W

GU10 max 1 x 11W

108353 ■ Antracite  
108261 ■ Bianco

124421 ■ Antracite  
124452 ■ Bianco

108407 ■ Antracite  
108384 ■ Bianco





# Inside

Montatura in fusione d'alluminio verniciato a polveri. Corpo luce posizionabile. Diffusore in vetro pirex trasparente. Dotato di lancia da interrare.

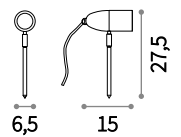

♀ Ⓢ IP54

G9 max 1 x 15W

115412 ■ Antracite  
115429 ■ Nero



# Krypton

Corpo luce in acciaio spazzolato. LED integrati. Diffusore posizionabile per l'orientamento del flusso luminoso.

**LED** Sorgente luminosa LED 4000 K, 15.000 h di durata.

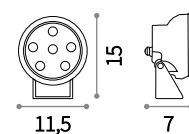

♀ Ⓧ IP65

LED 6W / 540 Lm

121970 ■ Acciaio



# Parete e soffitto









# Clio

Montatura in alluminio pressofuso e tornito, rifinito con vernici a polveri. Diffusore in materiale plastico bianco opaco.

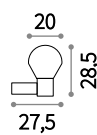

⊕ ⊖ IP44

E27 max 1x60W

146607 ■ Antracite  
146621 ■ Bianco

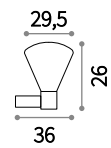

⊕ ⊖ IP44

E27 max 1x60W

187075 ■ Antracite  
187082 ■ Bianco

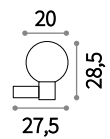

⊕ ⊖ IP44

E27 max 1x60W

135946 ■ Antracite  
146577 ■ Bianco



# Bubble

Montatura in alluminio pressofuso e tornito rifinito con vernici a polveri.  
Diffusore in materiale plastico bianco opaco.

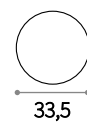
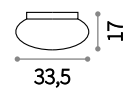

E27 max 1 x 60W

135250 ■ Bianco

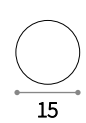
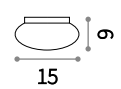

G9 max 2 x 15W

158907 ■ Bianco





# Pipeline

Corpo luce in metallo rifinito con vernice a polveri o zincato. Diffusore con vetro trasparente.

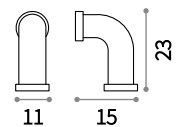

⊕ ⊖ IP44

GU10 max 1x35W

160597  Galvanize  
160559  Nero



# Xeno

Corpo luce in alluminio rifinito con vernice opaca a polveri. Diffusori orientabili con vetro temperato trasparente.

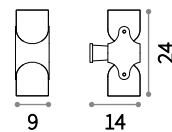

⌀ Ⓢ IP44

GU10 max 2 x 28W

- 129495  Bianco
- 213385  Coffee
- 129518  Grigio
- 129501  Nero

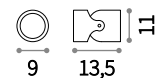

⌀ Ⓢ IP44

GU10 max 1 x 28W

- 129488  Bianco
- 213378  Coffee
- 129471  Grigio
- 129464  Nero



# Sunglasses

Corpo luce in alluminio verniciato a polveri. Diffusori inclinabili con schermi in vetro trasparente.

**LED** Sorgente luminosa LED 4000 K, 25.000 h di durata.

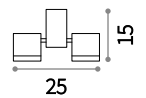

LED 14W / 1120 Lm

161846 ■ Antracite  
161853 ■ Bianco





# Omega Round

Corpo luce in alluminio verniciato a polveri. Diffusore inclinabile con schermo in materiale acrilico trasparente.

**LED** Sorgente luminosa LED 4000 K, 25.000 h di durata.

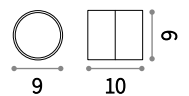

⊕ IP54

LED 7,3W / 573 Lm

172552 ■ Antracite  
172538 ■ Bianco  
165387 ■ Nero



# Iko

Corpo luce in alluminio pressofuso verniciato a polveri. Doppio diffusore, superiore e inferiore, in vetro temperato trasparente e sabbato.

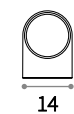
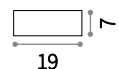

⊕ IP54

E27 max 1x60W

018515 ■ Antracite  
 018522 ■ Bianco  
 092218 ■ Grigio  
 018539 ■ Nero





# Astro

Corpo luce in alluminio pressofuso verniciato a polveri. diffusore, in vetro pirex trasparente sabbiato.



IP44

G9 max 1 x 25W

092157 ■ Antracite  
092164 ■ Bianco  
092171 ■ Nero





# Keope

Corpo luce e diffusore in resina ad alte prestazioni: inattaccabile dalla corrosione di agenti atmosferici; colori stabilizzati da trattamento U.V.. Resistente a sbalzi termici da -60° C a +90° C. Diffusori in materiale acrilico trasparente satinato.

**LED**

Lampadine LED E27 7W Sfera e LED GU10 5W 4000 K incluse.  
Cod. 151960/108292





# Abram

Corpo luce e diffusore in resina ad alte prestazioni: anti corrosione, anti U.V., da -60°a +90° C. Monta lampadina R7s LED sostituibile.

**LED** Lampadine LED R7s 4W 78 mm e 9,5W 118 mm 4000 K incluse.

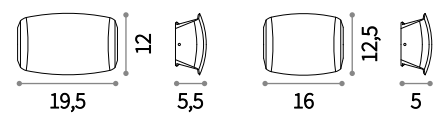

R7s max 1x8,5W

221915 ■ Bianco  
221922 ■ Nero

R7s max 1x4W

221892 ■ Bianco  
221908 ■ Nero



# Gun

Corpo luce in alluminio con finitura naturale spazzolata o in vernice con varie finiture. Diffusore in vetro pirex trasparente disponibile a luce singola o doppia, superiore e inferiore.

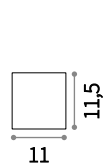

GU10 max 1 x 28W

- 092324 Alluminio
- 122663 Bianco
- 163666 Coffee
- 163642 Grigio
- 122687 Nero

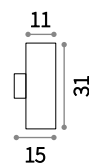

E27 max 2 x 60W

- 033020 Alluminio
- 092300 Bianco
- 163611 Coffee
- 163604 Grigio
- 092317 Nero

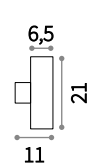

GU10 max 2 x 35W

- 033013 Alluminio
- 100388 Bianco
- 163635 Coffee
- 163628 Grigio
- 100395 Nero



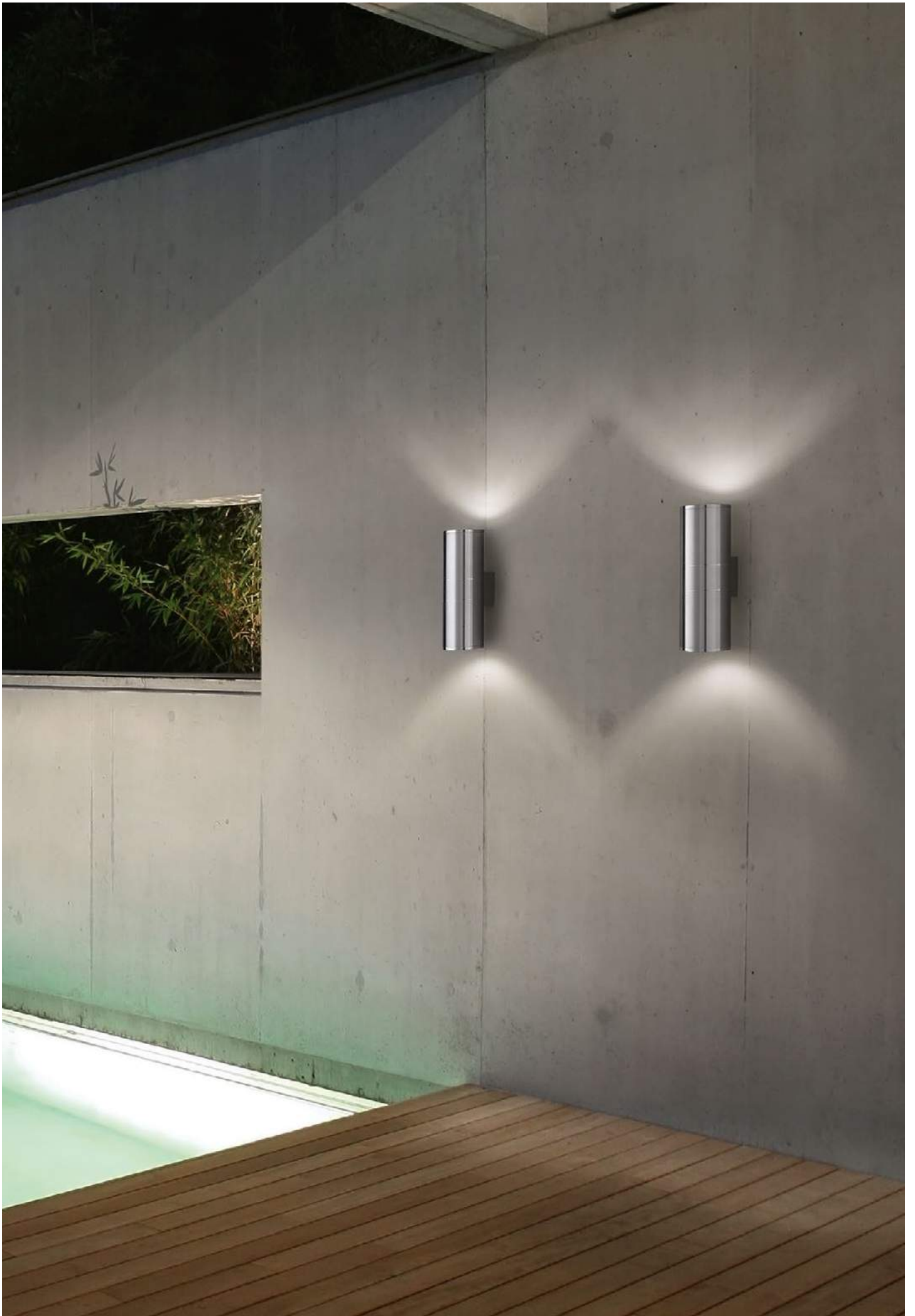



## Base

Corpo luce in alluminio pressofuso rifinito con vernice a polveri opaca. Doppio diffusore, superiore e inferiore, in vetro temperato trasparente.

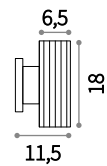

⊕ IP44

GU10 max 2x28W

129457  Bianco  
 129440  Grigio  
 129433  Nero



# Snif Round

Corpo luce in alluminio pressofuso verniciato. Doppio diffusore, superiore e inferiore, in vetro pirex trasparente.

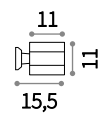

⊕ ⊖ ⚡ IP54

G9 max 1 x 40W

061467 ■ Antracite  
 144283 ■ Bianco  
 061474 ■ Grigio  
 061450 ■ Nero





# Lab

Corpo luce in fusione di alluminio verniciato a polveri. Diffusore con schermi in vetro trasparente. Emissione luce sopra e sotto.

**LED** Sorgente luminosa LED 4000 K, 25.000 h di durata.

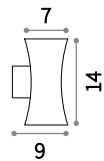

⊕ ⊖ IP44

LED 6W / 650 Lm

161556 ■ Antracite  
 161594 ■ Bianco  
 161617 ■ Nero



# Apollo

Corpo luce in alluminio pressofuso rifinito con vernice opaca a polveri in colore bianco o nero. Emissione luce sopra e sotto.

**LED** Sorgente luminosa LED 4000 K, 25.000 h di durata.

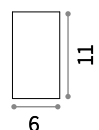
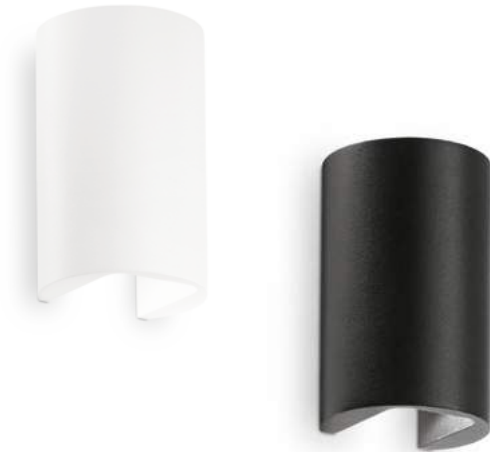

⊕ ⊖ IP44

LED 6W / 400 Lm

137407 ■ Bianco  
137391 ■ Nero



# Zeus

Corpo luce in alluminio grezzo spazzolato.  
Diffusori orientabili con vetro temperato  
trasparente e acidato.

**LED** Sorgente luminosa LED 4000 K,  
30.000 h di durata.

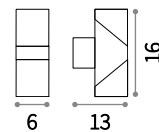

IP54

LED 10W / 1100 Lm

129532 ■ Alluminio

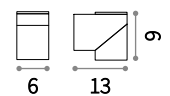

IP54

LED 5W / 550 Lm

129525 ■ Alluminio





# Omega Square

Corpo luce in alluminio verniciato a polveri. Diffusore inclinabile con schermo in materiale acrilico trasparente.

**LED** Sorgente luminosa LED 4000 K, 25.000 h di durata.

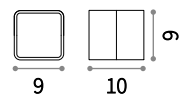

IP54

LED 7,3W / 573 Lm

172514 ■ Antracite  
172507 ■ Bianco  
165370 ■ Nero



# Up

Corpo luce in fusione di alluminio verniciato a polveri. Diffusori in vetro pirex trasparente satinato.

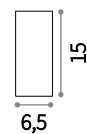

⌀ Ⓢ IP44

G9 max 2 x 15W

- 115337 ■ Antracite
- 115320 ■ Bianco
- 213354 ■ Coffee
- 115344 ■ Nero



⌀ Ⓢ IP44

G9 max 1 x 15W

- 115306 ■ Antracite
- 115290 ■ Bianco
- 213347 ■ Coffee
- 115313 ■ Nero





# Rubik

Corpo luce in fusione di alluminio verniciato a polveri. Struttura interna che riflette il fascio luminoso sia sopra sia sotto.

**LED** Sorgente luminosa LED 4000 K, 25.000 h di durata.

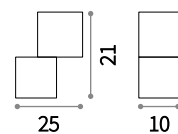

⌀ Ⓧ IP44

LED 14W / 1150 Lm

187341 ■ Antracite  
187358 ■ Bianco  
213255 ■ Coffee  
180045 ■ Nero



⌀ Ⓧ IP44

LED 6W / 570 Lm

149738 ■ Antracite  
149745 ■ Bianco  
213231 ■ Coffee  
142302 ■ Nero





# Twin

Corpo luce in alluminio pressofuso verniciato a polveri. Doppio diffusore, superiore e inferiore, in vetro pirex trasparente satinato.

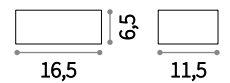

IP44

G9 max 1 x 28W

115368 ■ Antracite  
 115351 ■ Bianco  
 115375 ■ Nero





# Snif Square

Corpo luce in alluminio pressofuso verniciato. Doppio diffusore, superiore e inferiore, in vetro pirex trasparente.

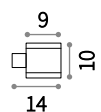

⊕ ⊖ ⚡ IP44

G9 max 1 x 40W

- 121963 ■ Antracite
- 144276 ■ Bianco
- 118666 ■ Grigio
- 123080 ■ Nero





# Tetris-1

Corpo luce in alluminio rifinito con vernice opaca a polveri. Diffusore in vetro temperato trasparente.

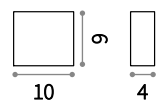

⊕ IP44

G9 max 1 x 15W

- 113753 ■ Antracite
- 114293 ■ Bianco
- 113760 ■ Grigio
- 113746 ■ Nero





# Tetris-2

Corpo luce in alluminio rifinito con vernice opaca a polveri. Diffusore in vetro temperato trasparente. Emissione luce sopra e sotto.

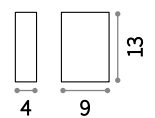

⊕ IP44

G9 max 2 x 15W

113791 ■ Antracite  
 113777 ■ Bianco  
 113807 ■ Grigio  
 113784 ■ Nero

# Andromeda

Corpo luce in alluminio pressofuso verniciato. Doppio diffusore, superiore e inferiore, in vetro pirex satinato.

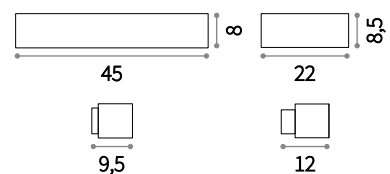

⌀ ⚡ IP54

E27 max 2 x 60W

- 092355 ■ Antracite
- 100364 ■ Bianco
- 163550 ■ Coffee
- 163543 ■ Grigio
- 100371 ■ Nero

⌀ ⚡ IP55

E27 max 1 x 60W

- 061580 ■ Antracite
- 066868 ■ Bianco
- 163536 ■ Coffee
- 158822 ■ Grigio
- 061597 ■ Nero









# Giove

Corpo luce in alluminio pressofuso verniciato a polveri. Doppio diffusore, superiore e inferiore, in vetro temperato trasparente sabbato.

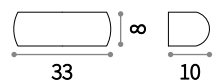

IP54

E27 max 1x60W

092188 ■ Antracite  
 092195 ■ Bianco  
 163598 ■ Coffee  
 092201 ■ Nero





# Francy

Corpo luce e diffusore in resina ad alte prestazioni: inattaccabile dalla corrosione sia di agenti atmosferici che di fertilizzanti chimici, colori stabilizzati da trattamento U.V., resistente a sbalzi termici da -60° C a +90° C.

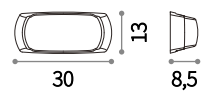
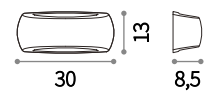

E27 max 1 x 23W

E27 max 1 x 23W

123745  Bianco  
 123738  Grigio  
 123752  Nero

123776  Bianco  
 123769  Grigio  
 123783  Nero



# Rex-1

Corpo luce in alluminio pressofuso verniciato a polveri. Diffusore bianco in materiale acrilico.

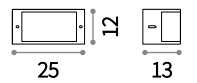

IP44

E27 max 1x60W

092409 ■ Antracite  
092393 ■ Bianco  
213217 ■ Coffee



# Rex-2

Corpo luce in alluminio pressofuso verniciato a polveri. Diffusore bianco in materiale acrilico.

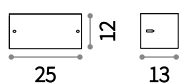

⊕ IP44

E27 max 1 x 60W

092423 ■ Antracite  
092416 ■ Bianco



# Rex-3

Corpo luce in alluminio pressofuso verniciato a polveri. Diffusore bianco in materiale acrilico.

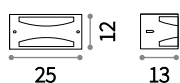

⊕ IP44

E27 max 1 x 60W

092447 ■ Antracite  
092430 ■ Bianco





# Cometa

Corpo luce in alluminio pressofuso rifinito con vernice a polveri. Diffusore in PVC bianco.

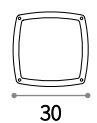
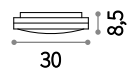

⊕ ⊖ IP54

E14 max 3x28W

082240 ■ Antracite  
082271 ■ Nero



# Mib

Base in alluminio verniciato a polveri.  
 Diffusore in materiale plastico opale.  
 Sorgente luminosa a led integrati.

**LED** Sorgente luminosa LED 4000 K,  
 30.000 h di durata.

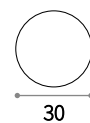
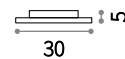

IP65  
 LED 20W / 1200 Lm  
 202945 ■ Bianco

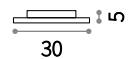

IP65  
 LED 20W / 1200 Lm  
 202921 ■ Bianco





## Germana

Corpo luce e diffusore in resina ad alte prestazioni: inattaccabile dalla corrosione sia di agenti atmosferici che di fertilizzanti chimici, colori stabilizzati da trattamento U.V., resistente a sbalzi termici da -60° C a +90° C. Diffusore a inclinazione variabile.

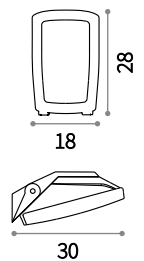

○ □ IP66

E27 max 1x23W

120188 □ Bianco  
120171 ■ Nero



# Urano

Corpo luce in alluminio tornito verniciato a polveri con finitura opaca. Diffusore in materiale acrilico trasparente e satinato.

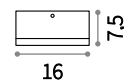

GX53 max 1 x 15W

168135 ■ Antracite  
168050 ■ Bianco

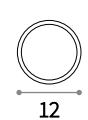
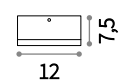

GX53 max 1 x 15W

168111 ■ Antracite  
168036 ■ Bianco





# Lucia

Corpo luce e diffusore in resina ad alte prestazioni: inattaccabile dalla corrosione sia di agenti atmosferici che di fertilizzanti chimici, colori stabilizzati da trattamento U.V., resistente a sbalzi termici da -60° C a +90° C.

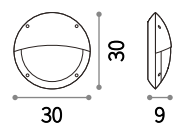
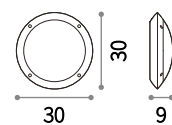

E27 max 1 x 23W

E27 max 1 x 23W

096667 ■ Bianco  
096674 ■ Nero

096681 ■ Bianco  
096698 ■ Nero





# Maddi

Corpo luce e diffusore in resina ad alte prestazioni: inattaccabile dalla corrosione sia di agenti atmosferici che di fertilizzanti chimici, colori stabilizzati da trattamento U.V., resistente a sbalzi termici da -60° C a +90° C.

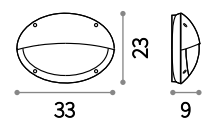
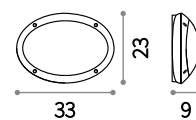

E27 max 1 x 23W

E27 max 1 x 23W

096711 ■ Bianco  
096704 ■ Nero

096735 ■ Bianco  
096728 ■ Nero



# Mike

Corpo luce in blocco unico d'alluminio pressofuso rifinito in vernice. Diffusore in vetro pirex.

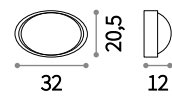

E27 max 1 x 60W

- 061818 ■ Antracite
- 066882 ■ Bianco
- 061801 ■ Nero

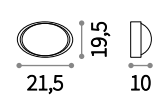

E27 max 1 x 25W

- 061788 ■ Antracite
- 066899 ■ Bianco
- 061771 ■ Nero



# Berta

Corpo luce e diffusore in resina ad alte prestazioni: inattaccabile dalla corrosione sia di agenti atmosferici che di fertilizzanti chimici, colori stabilizzati da trattamento U.V., resistente a sbalzi termici da -60° C a +90° C.

**LED** Lampadine LED GX53 3W/11W  
4000 K incluse.

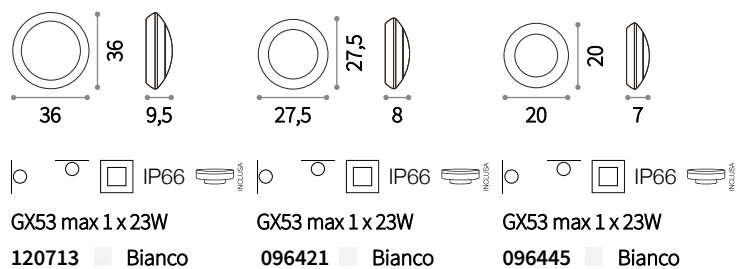





# Down

Montatura in alluminio pressofuso verniciato a polveri. Diffusore in acrilico.

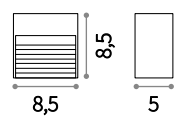

⊕ ⊖ IP44

G9 max 1 x 28W

122045 ■ Antracite  
115382 ■ Bianco



# Nina

Corpo luce e diffusore in resina ad alte prestazioni: anti corrosione, anti U.V., da -60°a +90° C. Emissione luce sopra e sotto.

**LED** Lampadine LED R7s 4W 78 mm e 8,5W 118 mm 3000 K/4000 K incluse.



R7s max 1 x 8,5W

R7s max 1 x 4W

221854	■ Bianco 3000K	221830	■ Bianco 3000K
221878	■ Bianco 4000K	221816	■ Bianco 4000K
221885	■ Nero 3000K	221847	■ Nero 3000K
221861	■ Nero 4000K	221823	■ Nero 4000K



# Incasso









# Park

Spot da incasso al suolo o parete. Corpo luce esterno in PVC. Parabola riflettente in alluminio. Cornice blocca vetro in acciaio satinato. Vetro trasparente.

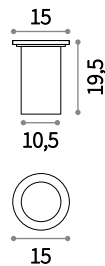

○ ⊕ IP54

E27 max 1 x 60W

032825 ■ Acciaio

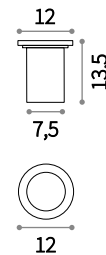

○ ⊕ IP54

GU10 max 1 x 20W

032832 ■ Acciaio

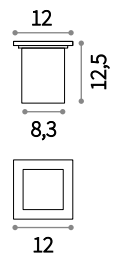

○ ⊕ IP54

G9 max 1 x 15W

117881 ■ Acciaio





# Park Led

Corpo luce in acciaio inox 316. Diffusore in vetro temperato trasparente. Calpestabile. Sorgente luminosa a led integrato. Assenza di viti a vista. Grado di protezione IP68. Disponibile con due versioni di cassaforma ad altezza diversa per una maggiore versatilità d'installazione.

**LED** Sorgente luminosa LED 4000 K, 50.000 h di durata.

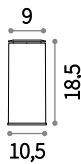

IP68  
LED 11,5W / 1100 Lm

222844 ■ Acciaio 20°  
222851 ■ Acciaio 60°

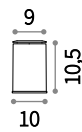

IP68  
LED 4,8W / 450 Lm

222868 ■ Acciaio 15°  
222875 ■ Acciaio 60°

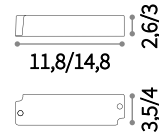

Driver  
Non incluso  
Necessario

226187 20 W  
226194 35 W

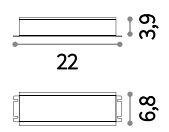

Driver  
Non incluso  
Necessario

226200 100 W  
226217 185 W





# Leti

Corpo luce e diffusore in resina ad alte prestazioni: inattaccabile dalla corrosione sia di agenti atmosferici che di fertilizzanti chimici, colori stabilizzati da trattamento U.V., resistente a sbalzi termici da -60° C a +90° C.

**LED** Lampadine LED GX53 3W 4000 K incluse.

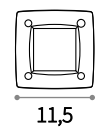
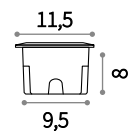
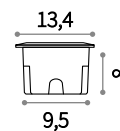

GX53 max 1 x 3W

096544 ■ Bianco  
096568 ■ Grigio  
096551 ■ Nero

GX53 max 1 x 3W

096575 ■ Bianco  
096599 ■ Grigio  
096582 ■ Nero





# Ceci

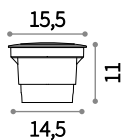

Corpo luce e diffusore in resina ad alte prestazioni: inattaccabile dalla corrosione sia di agenti atmosferici che di fertilizzanti chimici, colori stabilizzati da trattamento U.V., resistente a sbalzi termici da -60° C a +90° C. Carrabile fino a 5000 Kg.

**LED** Lampadine LED GU10 3,5W e LED GX53 10W 4000 K incluse.



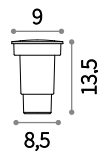



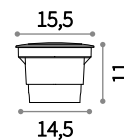

  
 GX53 max 1 x 10W  
 120324 ■ Nero





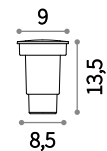



  
 GU10 max 1 x 4,5W  
 120249 ■ Nero





  
 GX53 max 1 x 10W  
 120386 ■ Nero







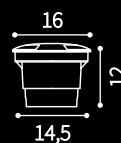

  
 GU10 max 1 x 4,5W  
 120317 ■ Nero

# Cecilia



Corpo luce e diffusore in resina ad alte prestazioni: inattaccabile dalla corrosione sia di agenti atmosferici che di fertilizzanti chimici, colori stabilizzati da trattamento U.V., resistente a sbalzi termici da -60° C a +90° C. Carrabile fino a 5000 Kg.

**LED** Lampadine LED GU10 3,5W e LED GX53 10W 4000 K incluse.



  IP67   
GX53 max 1 x 10W  
**120362** ■ Nero



  IP67   
GU10 max 1 x 4,5W  
**120287** ■ Nero







# Rocket Mini

Corpo luce in acciaio inox 316. Diffusore in vetro temperato trasparente. Calpestabile. Sorgente luminosa a led integrato. Assenza di viti a vista. Grado di protezione IP68. Disponibile nelle versioni a 1, 2 luci in radenza pavimento oppure con unica luce centrale d'accento.

**LED** Sorgente luminosa LED 4000 K, 50.000 h di durata.

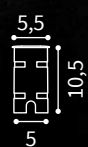

IP68  
LED 2W / 11 Lm

**212623** ■ Acciaio 15°  
**212647** ■ Acciaio 40°



IP68  
LED 2W / 140 Lm

**222820** ■ Acciaio  
**222837** ■ Acciaio



Driver Non incluso Necessario

**226187** 20 W  
**226194** 35 W

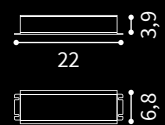

Driver Non incluso Necessario

**226200** 100 W  
**226217** 185 W





# Rocket

Apparecchio da incasso. Corpo luce in acciaio spazzolato. Diffusore in vetro pirex.

**LED** Sorgente luminosa LED 4000 K, 25.000 h di durata.



122014



122021



○ ⊕ IP65  
LED 3W / 200 Lm

**122014** ■ Acciaio

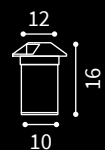

○ ⊕ IP65  
LED 3W / 200 Lm

**122021** ■ Acciaio













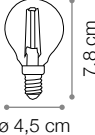

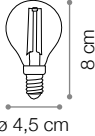

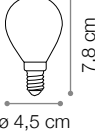

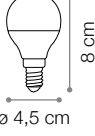
# Lampadine e accessori

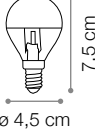

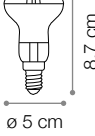

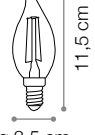
# Lampadine E14

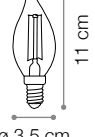

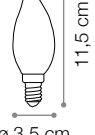
Lamp socket	Power	Flux	CCT	Life	Code	Dimmable		
		E14	4 W	400 Lm	3000 K	15.000 h	<b>188935</b>	✓
		E14	4 W	430 Lm	3000 K	15.000 h	<b>101200</b>	
		E14	4 W	450 Lm	4000 K	15.000 h	<b>153926</b>	
		E14	4 W	300 Lm	2200 K	15.000 h	<b>151656</b>	
		E14	4 W	360 Lm	3000 K	15.000 h	<b>101217</b>	
		E14	7 W	560 Lm	3000 K	25.000 h	<b>151731</b>	
		E14	7 W	600 Lm	4000 K	25.000 h	<b>151946</b>	
		E14	4 W	260 Lm	3000 K	15.000 h	<b>101262</b>	
		E14	4 W	430 Lm	3000 K	15.000 h	<b>101255</b>	
		E14	4 W	400 Lm	3000 K	15.000 h	<b>188911</b>	✓
		E14	4 W	430 Lm	3000 K	15.000 h	<b>101248</b>	
		E14	4 W	450 Lm	4000 K	15.000 h	<b>153940</b>	
		E14	4 W	300 Lm	2200 K	15.000 h	<b>151663</b>	
		E14	4 W	360 Lm	3000 K	15.000 h	<b>151793</b>	



101224 151748 151649



Lamp socket	Power	Flux	CCT	Life	Code	Dimmable
-------------	-------	------	-----	------	------	----------

E14	4 W	400 Lm	3000 K	15.000 h	<b>188928</b>	✓
-----	-----	--------	--------	----------	---------------	---

E14	4 W	430 Lm	3000 K	15.000 h	<b>101224</b>	
-----	-----	--------	--------	----------	---------------	--

E14	4 W	450 Lm	4000 K	15.000 h	<b>153933</b>	
-----	-----	--------	--------	----------	---------------	--

E14	4 W	300 Lm	2200 K	15.000 h	<b>151649</b>	
-----	-----	--------	--------	----------	---------------	--

E14	4 W	360 Lm	3000 K	15.000 h	<b>101231</b>	
-----	-----	--------	--------	----------	---------------	--





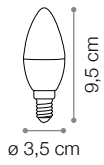
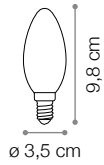
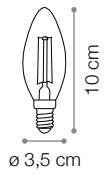
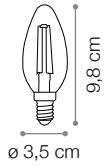





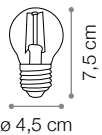



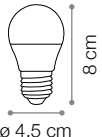

E14	7 W	560 Lm	3000 K	25.000 h	<b>151748</b>	
-----	-----	--------	--------	----------	---------------	--

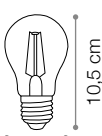
E14	7 W	600 Lm	4000 K	25.000 h	<b>151953</b>	
-----	-----	--------	--------	----------	---------------	--

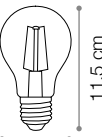





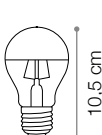





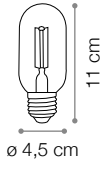

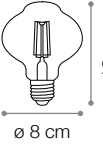

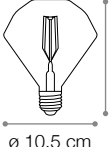
# Lampadine E27

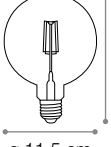

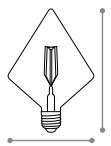
Lamp socket	Power	Flux	CCT	Life	Code	Dimmable		
		E27	4 W	400 Lm	3000 K	15.000 h	<b>188942</b>	✓
		E27	4 W	430 Lm	3000 K	15.000 h	<b>101279</b>	
		E27	4 W	450 Lm	4000 K	15.000 h	<b>153957</b>	
		E27	4 W	300 Lm	2200 K	15.000 h	<b>151861</b>	
		E27	4 W	360 Lm	3000 K	15.000 h	<b>101286</b>	
		E27	7 W	560 Lm	3000 K	25.000 h	<b>151755</b>	
		E27	7 W	600 Lm	4000 K	25.000 h	<b>151960</b>	
		E27	8 W	810 Lm	3000 K	15.000 h	<b>188973</b>	✓
		E27	4 W	430 Lm	3000 K	15.000 h	<b>101293</b>	
		E27	8 W	860 Lm	3000 K	15.000 h	<b>119571</b>	
		E27	8 W	920 Lm	4000 K	15.000 h	<b>153964</b>	
		E27	4 W	300 Lm	2200 K	15.000 h	<b>151687</b>	
		E27	8 W	720 Lm	3000 K	15.000 h	<b>123899</b>	
		E27	10 W	800 Lm	3000 K	25.000 h	<b>151762</b>	
		E27	10 W	850 Lm	4000 K	25.000 h	<b>151991</b>	
		E27	8 W	520 Lm	3000 K	15.000 h	<b>123882</b>	

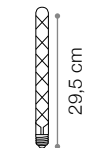

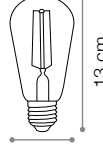
Lamp socket	Power	Flux	CCT	Life	Code	Dimmable
-------------	-------	------	-----	------	------	----------

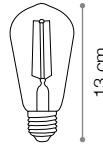
		E27	4 W	300 Lm	2200 K	15.000 h	<b>151700</b>	
		E27	4 W	380 Lm	2200 K	20.000 h	<b>201283</b>	
		E27	4 W	380 Lm	2200 K	20.000 h	<b>201269</b>	
		E27	4 W	380 Lm	2200 K	20.000 h	<b>201290</b>	
		E27	4 W	380 Lm	2200 K	20.000 h	<b>201276</b>	
		E27	6 W	580 Lm	2200 K	20.000 h	<b>201252</b>	
		E27	4 W	300 Lm	2200 K	15.000 h	<b>223919</b>	✓
		E27	4 W	300 Lm	2200 K	15.000 h	<b>151694</b>	
		E27	4 W	200 Lm	2200 K	15.000 h	<b>204451</b>	





# Lampadine E27



Lamp socket	Power	Flux	CCT	Life	Code	Dimmable
-------------	-------	------	-----	------	------	----------

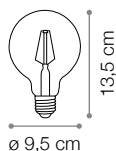

E27	8 W	810 Lm	3000 K	15.000 h	<b>188966</b>	✓
E27	8 W	860 Lm	3000 K	15.000 h	<b>101323</b>	
E27	8 W	920 Lm	4000 K	15.000 h	<b>153971</b>	

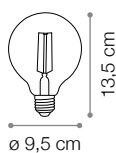

E27	4 W	300 Lm	2200 K	15.000 h	<b>223933</b>	✓
E27	4 W	300 Lm	2200 K	15.000 h	<b>151717</b>	

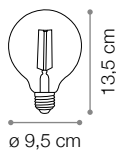

E27	4 W	200 Lm	2200 K	15.000 h	<b>204475</b>	
-----	-----	--------	--------	----------	---------------	--

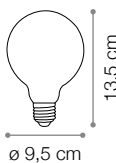

E27	8 W	720 Lm	3000 K	15.000 h	<b>101330</b>	
-----	-----	--------	--------	----------	---------------	--



E27	12 W	960 Lm	3000 K	25.000 h	<b>151779</b>	
E27	12 W	1020 Lm	4000 K	25.000 h	<b>151977</b>	

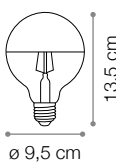

E27	8 W	780 Lm	3000 K	20.000 h	<b>157597</b>	
-----	-----	--------	--------	----------	---------------	--

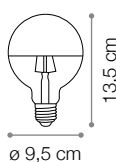

E27	8 W	520 Lm	3000 K	20.000 h	<b>135526</b>	
-----	-----	--------	--------	----------	---------------	--

101347

151724

204468



Lamp socket	Power	Flux	CCT	Life	Code	Dimmable
-------------	-------	------	-----	------	------	----------

E27	8W	810 Lm	3000 K	15.000 h	<b>188959</b>	✓
-----	----	--------	--------	----------	---------------	---

E27	8 W	860 Lm	3000 K	15.000 h	<b>101347</b>	
-----	-----	--------	--------	----------	---------------	--

E27	8 W	920 Lm	4000 K	15.000 h	<b>153988</b>	
-----	-----	--------	--------	----------	---------------	--

E27	4 W	300 Lm	2200 K	15.000 h	<b>223926</b>	✓
-----	-----	--------	--------	----------	---------------	---

E27	4 W	300 Lm	2200 K	15.000 h	<b>151724</b>	
-----	-----	--------	--------	----------	---------------	--

E27	4 W	200 Lm	2200 K	15.000 h	<b>204468</b>	
-----	-----	--------	--------	----------	---------------	--

E27	8 W	720 Lm	3000 K	15.000 h	<b>101354</b>	
-----	-----	--------	--------	----------	---------------	--

E27	15 W	1200 Lm	3000 K	25.000 h	<b>151786</b>	
-----	------	---------	--------	----------	---------------	--

E27	15 W	1300 Lm	4000 K	25.000 h	<b>152004</b>	
-----	------	---------	--------	----------	---------------	--

E27	8 W	780 Lm	3000 K	20.000 h	<b>157580</b>	
-----	-----	--------	--------	----------	---------------	--

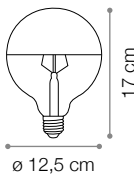
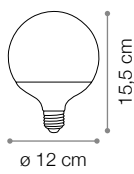
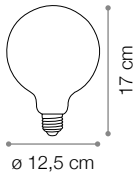
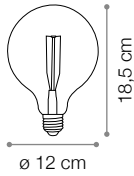
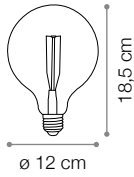
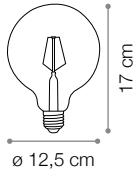

# Lampadine E27

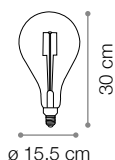

Lamp socket	Power	Flux	CCT	Life	Code	Dimmable
E27	8 W	600 Lm	2200 K	15.000 h	<b>223964</b>	✓
E27	8 W	640 Lm	2200 K	15.000 h	<b>130163</b>	

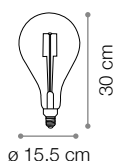

E27	8 W	400 Lm	2200 K	15.000 h	<b>204543</b>	
-----	-----	--------	--------	----------	---------------	--

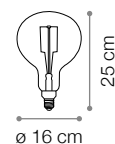

E27	4 W	320 Lm	2200 K	15.000 h	<b>223940</b>	✓
E27	4 W	320 Lm	2200 K	15.000 h	<b>129877</b>	

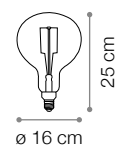

E27	4 W	300 Lm	2200 K	15.000 h	<b>204505</b>	
-----	-----	--------	--------	----------	---------------	--

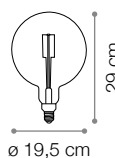

E27	4 W	320 Lm	2200 K	15.000 h	<b>223834</b>	✓
E27	4 W	320 Lm	2200 K	15.000 h	<b>130187</b>	

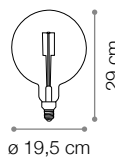

E27	4 W	200 Lm	2200 K	15.000 h	<b>204536</b>	
-----	-----	--------	--------	----------	---------------	--

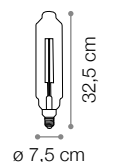

E27	4 W	320 Lm	2200 K	15.000 h	<b>130170</b>	
-----	-----	--------	--------	----------	---------------	--

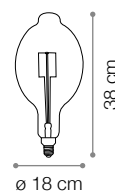

E27	4 W	320 Lm	2200 K	15.000 h	<b>129860</b>	
-----	-----	--------	--------	----------	---------------	--





Lamp socket	Power	Flux	CCT	Life	Code
-------------	-------	------	-----	------	------

		E27	26 W	1850 Lm	3000 K	13.000 h	<b>189147</b>
		E27	35 W	3085 Lm	3000 K	13.000 h	<b>189154</b>
		E27	48 W	4286 Lm	3000 K	13.000 h	<b>189161</b>
		E27	30 W	2500 Lm	3000 K	20.000 h	<b>189178</b>
		E27	40 W	3200 Lm	3000 K	20.000 h	<b>189185</b>
		E27	50 W	4000 Lm	3000 K	20.000 h	<b>189192</b>



# Lampadine G4

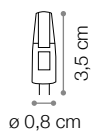

Lamp socket	Power	Flux	CCT	Life	Code
-------------	-------	------	-----	------	------

G4	1,5 W	200 Lm	3000 K	25.000 h	<b>188980</b>
----	-------	--------	--------	----------	---------------

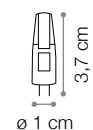

G4	2 W	170 Lm	3000 K	25.000 h	<b>222257</b>
----	-----	--------	--------	----------	---------------

# Lampadine G9

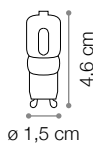

Lamp socket	Power	Flux	CCT	Life	Code
-------------	-------	------	-----	------	------

G9	2,5 W	200 Lm	3000 K	25.000 h	<b>122168</b>
----	-------	--------	--------	----------	---------------

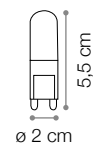

G9	2,7 W	350 Lm	3000 K	25.000 h	<b>189000</b>
----	-------	--------	--------	----------	---------------

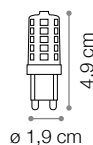

G9	3,2 W	300 Lm	3000 K	20.000 h	<b>209043</b>
----	-------	--------	--------	----------	---------------

G9	3,2 W	320 Lm	4000 K	20.000 h	<b>209036</b>
----	-------	--------	--------	----------	---------------

# Lampadine GU10

108292

101378

189062



Lamp socket	Power	Flux	CCT	Life	Code
-------------	-------	------	-----	------	------

GU10	5 W	400 Lm	3000 K	25.000 h	<b>108292</b>
------	-----	--------	--------	----------	---------------

GU10	7 W	640 Lm	3000 K	25.000 h	<b>123943</b>
------	-----	--------	--------	----------	---------------

GU10	7 W	680 Lm	4000 K	25.000 h	<b>224367</b>
------	-----	--------	--------	----------	---------------

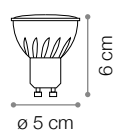
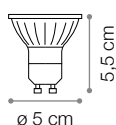

GU10	7 W	560 Lm	3000 K	25.000 h	<b>101378</b>
------	-----	--------	--------	----------	---------------

GU10	7 W	600 Lm	4000 K	25.000 h	<b>117652</b>
------	-----	--------	--------	----------	---------------

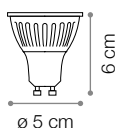

GU10	8 W	750 Lm	3000 K	25.000 h	<b>189062</b>
------	-----	--------	--------	----------	---------------

189794

189031



Lamp socket	Power	Flux	CCT	Life	Code
-------------	-------	------	-----	------	------

GU10	12 W	1050 Lm	3000 K	20.000 h	<b>183794</b>
------	------	---------	--------	----------	---------------

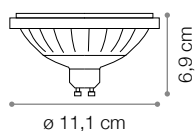

GU10	13 W	950 Lm	3000 K	15.000 h	<b>189031</b>
------	------	--------	--------	----------	---------------

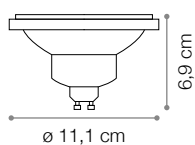



# Lampadine GX53

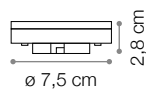

Lamp socket	Power	Flux	CCT	Life	Code
GX53	7 W	560 Lm	3000 K	25.000 h	<b>101385</b>

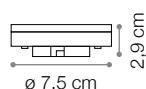

GX53	9,5 W	760 Lm	3000 K	25.000 h	<b>123936</b>
GX53	9,5 W	800 Lm	4000 K	25.000 h	<b>154008</b>

# Lampadine R7s

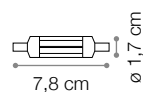

R7s	6 W	850 Lm	3000 K	30.000 h	<b>189109</b>
-----	-----	--------	--------	----------	---------------

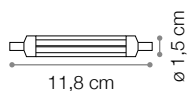

R7s	10 W	1200 Lm	3000 K	30.000 h	<b>189093</b>
-----	------	---------	--------	----------	---------------



# Strip LED and Driver

## STRIP LED



Power	Flux	CCT	IP	Code
13 W	1200 Lm	2700 K	IP20	<b>183336</b>
		3000 K	IP20	<b>124032</b>
	4000 K	IP65	<b>124056</b>	
		IP20	<b>124049</b>	
		IP65	<b>124063</b>	



Power	Flux	CCT	IP	Code
26 W	2200 Lm	2700 K	IP20	<b>183343</b>
	1500 Lm	3000 K	IP20	<b>151847</b>
	1600 Lm	4000 K	IP20	<b>151854</b>

## DRIVER



Power	Output	Current	Measures	Code
30 W	24 V	1250 mA	54 x 35 x 97 mm	<b>124070</b>
60 W	24 V	2500 mA	54 x 37 x 157 mm	<b>124087</b>
100 W	24 V	4500 mA	98 x 30 x 133 mm	<b>124100</b>
150 W	24 V	6500 mA	98 x 30 x 100 mm	<b>124117</b>
200 W	24 V	8300 mA	115 x 30 x 220 mm	<b>153001</b>





# Kit Emergency

Kit luce d'emergenza per moduli LED.  
 Include inverter e batteria. Autonomia  
 da due a tre ore con un tempo di  
 ricarica rispettivamente di 12 e 24 ore.  
 Funzionamento in sola emergenza  
 o in luce continua (luce continua in  
 abbinamento con alimentatori elettronici  
 e alimentatori elettronici dimmerabili).  
 Protetto in classe II.  
 Codice **221595**

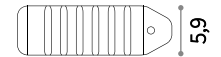
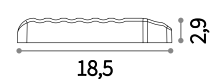
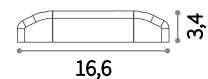

□ IP20

⌀ 52 mm

Peso 185 g

⌀ 65 mm

Peso 305 g

Per ulteriori informazioni, si prega di contattare l'ufficio tecnico.





# Chef

Sistema lineare a moduli con driver incorporati. Connessioni a innesto rapido. Fissaggio con supporti magnetici o adesivi.

**LED** Sorgente luminosa LED 3000 K, 25.000 h di durata.

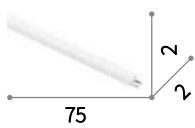

□ IP20  
LED 9W / 600 Lm  
167664 AP1 D75

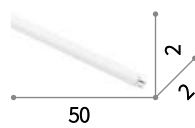

□ IP20  
LED 6W / 450 Lm  
167442 AP1 D50

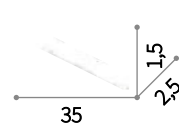

203157 Switch On-Off

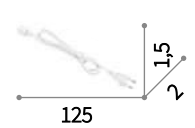

173900 Plug



# Rosoni

Rosoni a luce singola o multipla in metallo o ceramica con finiture varie. Cavi non inclusi.

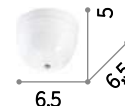
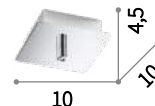
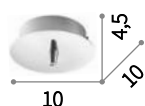
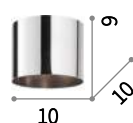

138091 SP5 Bianco  
138107 SP5 Cromo  
138114 SP5 Nero

122854 SP3 Bianco  
122861 SP3 Cromo  
123301 SP3 Nero

122823 SP1 Round Bianco  
122830 SP1 Round Cromo  
203270 SP1 Round Marrone  
123295 SP1 Round Nero

203232 SP1 Square Bianco  
203256 SP1 Square Cromo  
203263 SP1 Square Marrone  
203249 SP1 Square Nero

155166 Ceramica SP1 Bianco  
155159 Ceramica SP1 Nero

# Portalampada

Accessorio portalampada con rivestimento in ceramica smaltata o metallo. Versione in metallo fornito con ghiera.



E27 max 1 x 60W

155104 Ceramica Bianco  
155234 Ceramica Nero  
155111 Ceramica Rosso



E27 max 1 x 60W

187013 Metallo Cromo  
155180 Metallo Nickel Nero  
155173 Metallo Rame





# Cavi e Supporti

Supporti per cavi e cavi rivestiti in tessuto per composizioni a piacere con una o più sospensioni singole. Cavi disponibili con lunghezza su richiesta.



143224



143224



143224



 128849

 128832

 128825

 149530

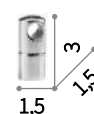

Ø 5 mm  
2 x 0,75 mm<sup>2</sup>  
FEP T180° + PVC T90°

128849 Cavo Tessuto Bianco	143200 Supporto Cavo Bianco
128832 Cavo Tessuto Nero	143224 Supporto Cavo Cromo
128825 Cavo Tessuto Rosso	143217 Supporto Cavo Nero
149530 Cavo Tessuto Vintage	

# Eliot

L'espositore è composto da sei ripiani liberi e un ripiano elettrificato avente cinque portalampade già cablati, ognuno dotato del proprio interruttore.

Tutti i ripiani sono dotati di porta prezzi in plastica. La struttura è realizzata in cartone alveolare, mentre il ripiano elettrificato è in Alucobest, garantito ignifugo.

Il montaggio è semplice e veloce:  
l'ingombro totale è di 59 x 178 x 46 cm.  
Codice 185590.



Portaprezzi in plastica



Interruttore



# Indice per codice





# Indice per codice

		004723	904	008363	094	012902	602	015767	634
		004730	904	008370	094	012919	176	015965	550
000206	218	005041	463	008455	094	013046	470	016016	686
000251	390	005126	356	008608	637	013060	470	016122	110
000268	390	005218	137	008615	637	013183	334	016399	446
000275	390	005225	316	008622	637	013206	334	016535	256
000305	334	005294	312	008776	147	013244	176	016559	256
000589	256	005379	322	008851	327	013275	327	016863	148
000619	641	005386	322	008905	326	013657	697	016870	593
000657	104	005454	312	008912	326	013756	223	016931	149
001180	688	005843	504	008929	648	013763	102	017013	593
001197	676	005881	611	009087	218	013787	618	017082	311
001814	189	005898	611	009131	218	013794	618	017297	324
001821	189	005911	622	009148	218	013800	618	017303	324
002040	167	006161	334	009155	218	013817	618	017310	653
002408	533	006321	346	009223	204	013923	102	017327	654
002491	296	006338	346	009360	132	014166	294	017334	325
002507	296	006529	273	009377	346	014371	356	017440	144
002705	353	006543	273	009384	132	014395	533	017518	840
002767	353	006550	273	009391	132	014432	326	017587	179
002774	353	006840	153	009407	132	014449	326	017600	179
002781	353	007021	322	009414	132	014456	649	017617	179
002880	602	007038	322	009483	346	014593	179	017716	695
002897	639	007045	322	009513	291	014609	380	017754	160
002903	639	007069	322	009537	291	014616	380	018010	550
003108	167	007113	273	009681	252	014623	638	018027	550
003283	578	007151	544	009698	252	014630	638	018072	562
003399	578	007380	297	009704	506	014814	204	018089	110
003528	446	007397	297	009933	287	014920	686	018508	285
003535	446	007533	618	009940	287	014968	550	018515	942
004099	506	007557	296	009957	287	014975	550	018522	942
004211	273	007953	506	010069	392	015101	640	018539	942
004235	273	007960	309	010861	285	015118	640	018546	256
004358	327	007977	309	010892	909	015125	640	018775	641
004419	622	007984	309	012209	446	015132	640	018829	348
004426	622	007991	309	012605	356	015286	446	018836	348
004556	569	008325	094	012865	602	015439	562	018850	348
004686	114	008349	094	012872	602	015446	562	018874	327
004716	904	008356	094	012889	602	015750	695	019376	499

019383	499	022772	511	026961	904	031477	335	033044	926
019390	499	022789	500	026978	904	031484	317	033532	522
019451	547	022819	463	026985	904	031491	317	033662	154
019468	547	022987	578	026992	904	031507	654	033679	154
019499	531	023021	145	027005	904	031644	114	033686	154
019635	306	023038	145	027081	315	031651	114	033921	146
019642	306	023182	563	027098	315	031668	114	033938	088
019734	206	023328	110	027104	315	031675	114	033945	088
019741	206	024097	894	027265	314	031712	569	033952	145
019758	206	024134	894	027289	381	031743	090	034393	676
019765	206	024486	616	027357	146	031750	090	034416	676
019772	380	024493	616	027364	146	031996	204	034546	293
020228	910	024509	616	027418	488	032009	204	034706	508
020365	544	024523	616	027425	488	032016	204	034713	508
020372	544	025032	578	027616	512	032023	204	034720	508
020556	531	025261	462	027623	512	032030	204	034737	508
020594	563	025278	462	027630	512	032047	204	034935	694
020600	563	025285	462	027821	488	032078	204	034942	694
020716	455	025292	462	027838	488	032078	204	035031	396
020723	455	025308	462	027852	446	032122	218	035093	396
020747	455	025315	462	027876	446	032139	218	035185	290
020822	603	025421	192	027906	190	032313	682	035192	290
020839	603	025438	192	027975	547	032351	238	035369	685
020846	603	025490	544	028323	291	032368	238	035505	164
020853	603	026008	544	028361	291	032375	238	035512	164
020877	603	026039	563	028460	611	032382	238	035529	164
020891	306	026084	690	028682	273	032436	677	035536	164
020969	505	026299	511	028699	273	032467	677	035543	164
020976	505	026473	310	030210	533	032504	488	035567	164
020983	505	026480	310	030326	178	032511	488	035574	558
021416	618	026510	223	030784	088	032573	570	035581	558
021430	618	026558	312	031071	350	032597	570	035598	558
022222	088	026565	312	031088	350	032610	570	035604	516
022239	088	026695	547	031095	350	032672	570	035611	516
022277	084	026749	152	031101	350	032825	978	035628	516
022420	223	026787	178	031361	294	032832	978	035635	516
022499	200	026855	682	031446	335	033013	946	035642	514
022505	200	026862	682	031453	335	033020	946	035642	514
022765	511	026954	904	031460	335	033037	926	035659	514



# Indice per codice

		044392	482	051741	368	059228	560	062273	368
		044422	482	051765	368	059235	560	062389	796
035659	514	044453	482	051840	313	059242	560	062396	796
035666	177	044491	689	051857	313	059259	560	062402	796
035673	177	044538	266	051864	313	059266	560	062501	114
035680	177	044545	266	051932	287	059563	087	063614	132
035697	177	044590	393	051949	287	059570	087	063621	132
035703	177	044606	393	051956	287	059631	160	066387	108
035710	177	044750	530	051963	287	059648	160	066394	108
035727	180	044767	530	051970	287	059655	160	066400	122
035826	552	044774	530	051987	287	059679	184	066417	122
035840	552	044910	534	052144	310	059808	218	066424	122
035864	552	044927	534	052151	310	059815	218	066431	560
035925	243	044934	534	052359	121	059822	218	066448	560
035932	243	045030	697	052366	121	059839	218	066592	180
035949	279	045047	697	052373	121	060224	222	066608	180
035956	279	045115	151	052786	180	060231	222	066622	613
035987	691	045122	151	052793	162	060491	534	066639	613
036007	691	045139	151	052809	162	060507	534	066790	342
036014	252	045146	151	052816	162	060514	534	066806	342
036021	252	045191	132	052984	118	060620	290	066813	342
036045	114	045207	132	052991	118	060774	314	066820	342
036076	200	045214	132	053004	118	060781	314	066868	960
036120	167	045221	132	053011	118	060798	314	066882	972
038025	201	045627	318	053028	118	061115	374	066899	972
038261	137	045634	318	053448	145	061122	374	068121	182
041827	522	045672	503	053455	145	061139	374	068138	182
042794	676	045726	307	054995	092	061160	377	068145	182
043531	256	045733	307	057187	611	061191	377	068169	182
043562	218	046167	926	057194	611	061450	949	068176	182
044163	122	046181	926	057200	611	061467	949	068183	490
044187	122	046211	926	059112	108	061474	949	068190	490
044194	122	046334	388	059129	108	061580	960	068268	548
044200	122	046341	388	059136	108	061597	960	068275	548
044248	468	047799	154	059143	108	061771	972	068299	548
044255	468	049229	294	059150	108	061788	972	068305	548
044279	309	049236	294	059181	108	061801	972	068350	111
044286	309	051406	689	059198	108	061818	972	068398	111
044293	309	051444	840	059211	560	062211	530	068459	093

068466	093	074726	394	077758	554	081748	474	083254	805
071015	185	074740	076	077765	554	081762	154	086576	072
071022	185	074764	087	077796	116	081779	154	086729	212
073118	614	074771	076	077802	116	081960	072	086736	212
073132	614	074801	076	077819	116	082059	084	086743	212
073149	614	074870	397	077826	116	082073	084	086781	212
073156	614	074900	258	077833	116	082158	528	086804	212
073187	106	074917	258	077888	342	082172	528	087269	546
073224	106	074931	258	077895	342	082196	528	087276	453
073255	106	074955	160	077901	342	082240	966	087368	470
073262	106	074962	258	077918	342	082257	528	087375	470
073392	556	075013	258	077932	351	082264	528	087382	688
073408	556	075044	352	077949	351	082271	966	087573	302
073422	556	075051	352	077956	351	082288	528	087580	302
073439	556	075075	352	077963	351	082387	232	087597	302
073453	500	075082	352	079387	556	082424	160	087665	246
073521	842	075150	516	079400	554	082431	160	087672	246
073545	842	075181	516	080277	094	082448	232	087689	246
073569	842	075211	576	080284	112	082493	232	087702	246
073583	822	075242	600	080291	112	082509	232	087719	246
073606	634	075280	600	080338	112	082783	116	087757	484
073613	634	075310	600	080345	112	082790	116	087764	484
073651	536	075327	600	080352	112	082806	116	087771	484
073712	084	075334	600	080369	112	082813	116	087818	172
073729	536	075341	600	080376	112	083070	804	087863	104
073828	063	075389	106	080390	304	083087	804	087870	104
073835	063	075402	106	080857	112	083100	804	087924	086
073859	063	075419	106	080888	490	083117	804	087979	106
074139	201	075471	254	080932	116	083124	804	088013	106
074221	227	075488	254	081434	304	083131	804	088020	106
074245	174	075495	254	081441	304	083148	804	088051	564
074313	174	075501	254	081496	466	083162	804	088068	564
074337	174	075518	254	081502	466	083179	804	088105	564
074344	174	075525	254	081519	466	083186	804	088136	564
074627	072	075532	254	081526	466	083193	804	088143	564
074641	272	077697	188	081533	466	083209	804	088167	564
074665	272	077703	188	081540	466	083223	804	088266	294
074689	072	077734	554	081557	466	083230	804	088273	294
074702	394	077741	554	081564	466	083247	804	088433	615

# Indice per codice

		092157	943	093512	271	095707	344	099101	236
		092164	943	093550	604	095998	841	099118	236
088440	615	092171	943	093659	458	096018	841	099163	100
088631	242	092188	962	093680	458	096100	232	099170	100
088921	167	092195	962	093697	458	096162	232	099200	100
088938	167	092201	962	093703	642	096421	973	099217	100
088969	167	092218	942	093758	605	096445	973	100272	610
089430	634	092225	920	093789	605	096476	929	100289	610
089454	634	092300	946	093796	605	096483	929	100296	610
089461	635	092317	946	093857	605	096544	980	100302	610
089478	635	092324	946	093963	201	096551	980	100326	454
089485	635	092355	960	093987	496	096568	980	100333	454
089560	346	092393	964	093994	496	096575	980	100364	960
089577	346	092409	964	094007	496	096582	980	100371	960
089584	346	092416	965	094014	201	096599	980	100388	946
089591	346	092423	965	094021	576	096667	970	100395	946
089614	142	092430	965	094045	468	096674	970	100425	622
089638	120	092447	965	094120	468	096681	970	100432	612
089669	120	092577	242	094137	163	096698	970	100746	528
089775	909	092751	612	094182	841	096704	971	100784	528
089782	386	092782	612	094229	163	096711	971	100791	528
089805	386	092836	422	094236	163	096728	971	100807	528
090252	507	092850	422	094649	116	096735	971	100883	080
090269	507	092881	422	094663	116	097183	330	100913	080
090276	507	092911	526	094687	088	097190	330	100937	080
090337	283	092942	422	094786	622	097206	330	100944	080
090481	201	093000	624	094793	622	097664	611	100951	080
090764	147	093024	086	095127	356	097671	611	100982	685
090863	246	093048	104	095196	210	098043	271	101095	188
090900	246	093062	104	095226	210	098586	210	101101	188
091006	304	093079	624	095264	297	098616	210	101118	132
091013	304	093086	104	095288	297	098722	098	101125	206
091112	151	093093	104	095615	468	098739	098	101132	206
091129	294	093147	568	095622	468	098777	098	101149	206
091136	294	093307	185	095639	468	098784	098	101156	236
091143	120	093321	568	095653	344	098944	336	101163	236
091518	910	093345	306	095677	344	098951	336	101170	088
091525	910	093475	522	095684	344	099057	346	101187	088
091983	356	093505	271	095691	344	099064	348	101194	088



101200	988	103518	470	108353	930	111896	558	113715	236
101217	988	103693	859	108384	930	111902	163	113746	958
101224	988	103709	859	108407	930	111919	163	113753	958
101231	988	103723	066	109138	904	111940	070	113760	958
101248	988	103792	522	109145	904	111957	070	113777	959
101255	988	103983	148	110233	362	112084	149	113784	959
101262	988	103990	149	110240	362	112107	149	113791	959
101279	990	104294	576	110257	362	112251	070	113807	959
101286	990	104355	846	110356	358	112268	070	113975	594
101293	990	104485	308	110363	358	112299	070	113982	805
101323	990	104508	308	110370	358	112305	416	113999	805
101330	990	104515	308	110417	128	112312	416	114019	805
101347	990	104539	308	110424	128	112336	416	114170	466
101354	990	104546	308	110431	128	112343	416	114187	466
101378	997	104775	468	110448	362	112367	144	114194	466
101385	998	104812	468	110455	362	112381	144	114200	466
101491	896	104928	138	110462	128	112398	501	114224	558
101514	896	104935	138	110479	362	112404	501	114262	066
101552	896	104942	138	110509	687	112435	501	114279	522
101576	074	105239	096	110516	687	112459	144	114293	958
101590	074	105277	096	110530	362	112626	443	114347	922
101606	074	105284	096	110554	362	112671	132	114361	075
101613	074	105628	246	110578	362	112695	443	114521	512
102047	458	105659	671	110684	242	112701	443	114620	104
102054	458	105710	850	110745	175	112718	132	114675	522
103112	191	105727	851	110752	175	112732	443	114682	522
103136	191	105734	851	110868	241	112800	524	114729	522
103174	419	105741	850	110875	574	112817	524	114736	522
103204	279	106021	088	110882	574	112848	524	114743	522
103204	279	106175	909	110899	574	113197	524	114750	274
103242	246	106182	909	111117	073	113302	135	114767	274
103266	246	106205	926	111452	192	113319	135	114811	075
103273	246	107684	662	111490	498	113333	130	115061	918
103327	548	107691	663	111551	498	113357	130	115078	918
103419	472	107707	663	111841	172	113364	130	115085	918
103426	472	108094	376	111858	172	113562	546	115092	918
103433	472	108117	376	111865	172	113654	482	115108	918
103440	636	108261	930	111872	558	113678	482	115115	918
103501	470	108292	997	111889	558	113692	236	115122	912

# Indice per codice

		116112	285	120324	981	122571	832	124063	999
		116228	526	120362	982	122588	548	124070	999
115153	288	116235	526	120386	981	122601	548	124087	999
115160	288	116457	136	120423	896	122663	946	124100	999
115177	288	116464	136	120430	896	122687	946	124117	999
115191	288	116570	390	120454	896	122717	346	124124	758
115290	954	116587	390	120713	973	122731	346	124131	758
115306	954	116594	390	120898	416	122748	346	124155	758
115313	954	116600	468	120904	416	122823	1002	124162	278
115320	954	116617	468	121130	650	122830	1002	124179	278
115337	954	116624	468	121147	650	122847	130	124421	930
115344	954	116884	513	121154	650	122854	1002	124452	930
115351	956	117652	997	121161	650	122861	1002	125480	203
115368	956	117737	543	121178	650	122878	687	125503	194
115375	956	117782	494	121338	650	122885	687	125510	194
115382	974	117867	282	121352	649	122984	348	125565	194
115412	931	117881	978	121376	386	123066	282	125824	460
115429	931	118659	904	121406	386	123080	957	125831	460
115481	843	118666	957	121413	386	123295	1002	125886	282
115498	594	118970	317	121437	386	123301	1002	125923	282
115504	594	118987	317	121574	609	123738	963	126531	758
115511	594	119410	130	121864	609	123745	963	126548	758
115580	662	119427	130	121963	957	123752	963	126760	680
115597	662	119458	130	121970	932	123769	963	126784	680
115610	662	119465	130	122014	985	123776	963	126807	680
115696	236	119502	130	122021	985	123783	963	126883	140
115719	236	119571	990	122045	974	123882	990	126890	140
115740	203	119755	648	122052	463	123899	990	126906	140
115801	073	119786	660	122083	438	123936	998	126913	140
115832	566	119816	660	122106	438	123943	997	128207	594
115849	566	119830	660	122168	996	123974	794	128825	1004
115863	566	119908	660	122205	246	123981	794	128832	1004
115962	588	120171	968	122212	246	123998	794	128849	1004
115979	588	120188	968	122236	246	124001	794	129082	128
115986	588	120201	929	122243	246	124018	794	129099	128
115993	588	120218	929	122267	344	124025	794	129242	696
116006	588	120249	981	122274	344	124032	999	129433	948
116099	280	120287	982	122557	419	124049	999	129440	948
116105	280	120317	981	122564	419	124056	999	129457	948

129464	939	132952	240	135786	893	136905	140	138374	135
129471	939	132969	240	135816	586	136929	140	138510	916
129488	939	132976	240	135823	586	136936	140	138527	366
129495	939	133041	062	135854	920	136943	140	138596	281
129501	939	133058	062	135908	908	136998	817	138602	281
129518	939	133263	277	135922	908	137001	817	138619	281
129525	952	133270	277	135946	936	137018	060	138633	281
129532	952	133294	277	135991	874	137032	060	138640	281
129570	596	133300	277	136004	874	137056	060	138657	281
129600	596	133386	270	136011	874	137117	432	138800	882
129693	582	133393	270	136028	923	137124	432	138879	882
129709	582	133409	270	136035	923	137131	432	138886	882
129860	990	133874	124	136042	923	137261	186	138893	882
129877	990	133881	124	136059	923	137285	186	138978	804
129921	582	133898	124	136097	888	137292	186	138985	804
130163	990	133904	124	136103	888	137308	186	138992	804
130170	990	133911	124	136127	888	137315	186	139012	800
130187	990	133959	670	136141	884	137391	951	139029	802
130903	584	134208	628	136158	884	137407	951	139098	457
130910	584	134215	628	136172	884	137599	322	139425	438
131719	696	134246	452	136189	886	137605	322	139432	438
131733	696	134789	837	136202	886	137612	322	139470	910
131757	696	134796	837	136226	886	137681	456	139579	893
131771	629	134826	585	136318	267	137698	522	139586	586
131788	629	134833	585	136325	267	137704	522	139593	586
131795	629	134840	585	136332	444	137827	385	139609	588
131924	218	134871	460	136349	444	137841	385	139678	134
131955	878	134888	305	136561	826	137995	867	139685	134
131962	837	134895	305	136578	826	138008	867	139746	844
132013	214	134901	305	136585	826	138091	1002	139951	646
132112	510	134987	293	136592	826	138107	1002	140001	646
132129	510	135038	440	136691	424	138114	1002	140179	637
132204	203	135175	591	136707	424	138237	866	140186	637
132228	203	135205	913	136714	424	138251	839	140193	637
132365	196	135212	913	136721	424	138275	066	140230	218
132389	196	135250	937	136738	424	138282	371	140247	680
132778	364	135526	990	136875	582	138305	158	140315	680
132785	364	135755	916	136882	140	138343	590	140322	680
132945	240	135762	916	136899	140	138367	135	140339	496



# Indice per codice

		141855	138	143187	246	146836	886	149462	884
		141893	262	143200	1004	146843	886	149479	884
140520	858	141909	262	143217	1004	146850	886	149486	884
140537	816	141916	262	143224	1004	146867	886	149493	884
140544	816	141923	590	143842	325	146874	886	149509	884
140551	816	141954	590	143859	325	146881	886	149530	1004
140599	476	142050	348	144191	886	147208	888	149547	158
140605	476	142067	348	144214	888	147215	888	149561	158
140612	476	142081	348	144221	884	147222	888	149585	158
140629	476	142098	348	144276	957	147260	888	149585	158
140711	156	142180	280	144283	949	147277	888	149592	163
140728	156	142197	280	144320	128	147284	888	149592	163
140759	156	142203	280	144818	666	147291	884	149608	270
140827	590	142227	470	144849	666	147307	884	149615	270
140841	812	142241	333	144856	666	147314	884	149622	270
140865	812	142258	333	144863	666	147352	884	149684	422
140872	812	142265	828	144917	652	147369	884	149738	955
140896	812	142272	828	145112	884	147376	884	149745	955
140902	812	142289	828	145198	672	147383	884	149943	888
140926	812	142296	828	145204	672	147390	884	149950	888
140933	812	142302	955	145211	672	147635	379	149967	888
140957	812	142333	286	145303	928	147642	379	149974	888
141046	484	142340	286	145310	928	147659	379	149981	888
141053	484	142357	636	145327	928	147666	794	149998	888
141060	484	142364	636	145334	928	147673	794	150000	888
141084	502	142517	424	145341	928	147680	794	150017	886
141107	130	142579	333	145358	928	147765	944	150024	886
141138	130	142586	333	145365	371	147772	944	150031	886
141145	130	142593	684	146294	592	147789	944	150048	886
141268	845	142616	684	146317	384	147796	944	150055	886
141275	845	142630	395	146546	886	147802	944	150062	886
141282	389	142647	395	146553	886	147819	944	150079	886
141329	266	142692	332	146560	886	148151	436	150116	802
141336	266	142708	332	146577	936	148175	436	150130	800
141480	281	142906	860	146607	936	148502	436	150284	799
141497	281	142913	860	146621	936	148908	135	150291	802
141794	138	142999	916	146645	888	148922	884	150307	800
141800	138	143156	246	146652	888	148939	596	150420	821
141817	138	143163	246	146669	888	149455	884	150437	821

150468	821	153124	857	155494	656	158686	138	160269	406
150475	821	153162	898	155500	366	158709	626	160313	406
150581	848	153179	898	155623	668	158723	138	160559	938
150628	862	153193	898	155630	668	158785	626	160597	938
150635	862	153209	898	155722	799	158808	626	160856	215
150666	862	153421	442	155791	824	158815	052	160863	215
150673	862	153438	442	155869	824	158822	960	161327	156
151649	988	153445	442	155906	424	158860	052	161334	156
151656	988	153513	260	155968	065	158891	906	161365	216
151663	988	153520	260	155982	847	158907	937	161372	216
151687	990	153537	260	156026	065	159010	262	161389	216
151694	990	153544	260	156033	065	159256	580	161433	216
151700	990	153599	678	156316	412	159263	631	161457	899
151717	990	153612	678	156323	412	159317	631	161556	950
151724	990	153636	678	156330	412	159423	318	161594	950
151731	988	153926	988	156347	412	159508	318	161617	950
151748	988	153933	988	156392	656	159522	318	161648	248
151755	990	153940	988	156408	656	159553	064	161662	248
151762	990	153957	990	156415	656	159560	064	161686	248
151779	990	153964	990	156682	860	159638	292	161716	248
151786	990	153971	990	156699	860	159645	292	161754	879
151793	988	153988	990	156705	842	159812	580	161761	879
151847	999	154008	998	156712	822	159836	890	161778	879
151854	999	154800	944	156729	843	159843	428	161785	836
151861	990	154817	944	156736	843	159850	428	161792	836
151946	988	154824	944	156743	843	159867	428	161846	940
151953	988	155104	1003	156774	823	159935	480	161853	940
151960	990	155111	1003	156781	823	159942	480	161907	907
151977	990	155142	643	157030	857	159959	480	161921	907
151991	990	155159	1002	157122	265	159966	480	162089	835
152004	990	155166	1002	157139	265	159973	480	162102	835
152684	697	155173	1003	157146	265	159980	480	162201	410
152776	625	155180	1003	157160	265	159997	647	162416	426
152851	279	155227	643	157580	990	160016	647	162478	410
152875	250	155234	1003	157597	990	160023	228	162492	906
152899	250	155395	831	157719	244	160030	228	162737	581
152912	250	155401	831	157856	919	160085	625	162744	581
153001	999	155418	831	158242	248	160214	406	162751	581
153100	421	155425	831	158655	138	160245	406	162782	581

# Indice per codice

		165387	941	167664	1001	169613	752	173115	441
		166209	436	168036	969	169620	752	173122	441
163109	439	166247	543	168050	969	169637	752	173900	1001
163116	439	166254	542	168067	608	169644	752	173917	608
163123	439	166261	542	168081	608	169705	752	174204	461
163154	439	166285	542	168111	969	169712	752	174211	461
163161	439	166322	542	168135	969	169729	752	174228	461
163321	438	166360	542	168159	440	169736	752	174235	461
163338	438	166377	451	168180	440	169781	752	174242	446
163369	132	166384	451	168234	244	169798	752	174396	230
163536	960	166421	599	168258	474	169804	752	174402	230
163543	960	166483	599	168289	474	169897	752	174419	058
163550	960	166544	536	168319	170	169903	752	174426	058
163598	962	166551	536	168326	170	169910	752	174433	058
163604	946	166650	674	168357	170	169927	752	174792	338
163611	946	166667	674	168364	170	169958	752	174808	338
163628	946	166742	674	168579	418	169972	752	174822	338
163635	946	166766	674	168586	418	169989	752	174846	338
163642	946	166841	486	168609	418	170145	752	174914	532
163666	946	166889	486	168746	509	170152	752	174921	056
163727	926	166988	168	168753	509	170589	138	174945	532
163741	904	167015	168	168777	509	170596	140	174952	056
163758	904	167022	168	168791	606	170602	140	174976	056
163772	416	167107	168	168821	606	170923	294	174990	056
163789	416	167121	328	168838	606	172347	914	175010	056
164601	254	167152	328	168852	621	172408	914	175041	056
164823	841	167244	514	168869	621	172422	914	175072	056
164847	841	167251	514	168906	482	172439	914	175096	056
164878	860	167268	514	168913	543	172507	953	175119	056
164953	534	167282	436	168920	543	172514	953	175287	226
164960	534	167367	436	168937	543	172538	941	175294	226
164977	528	167398	514	168951	620	172552	941	175317	424
164984	528	167404	514	168968	620	172781	752	175324	424
164991	528	167411	514	169118	297	172804	194	175331	424
165004	528	167442	1001	169125	297	172828	194	175348	424
165011	548	167497	436	169576	752	172996	166	175355	424
165066	068	167503	436	169583	752	173009	166	175676	300
165080	068	167626	170	169590	752	173016	166	175690	300
165370	953	167640	170	169606	752	173023	166	175706	300



175720	301	179902	516	187365	294	188164	752	189697	744
175768	301	180045	955	187389	422	188171	752	189703	744
175799	301	180212	644	187433	464	188188	752	189710	744
175935	134	180229	644	187440	464	188195	752	189727	744
175973	150	180298	643	187457	464	188911	988	189734	744
176000	150	180304	643	187525	892	188928	988	189741	744
176031	150	180922	596	187532	892	188935	988	189758	744
176062	150	180946	596	187549	892	188942	990	189765	744
176260	143	180953	870	187556	892	188959	990	189772	744
176277	143	180960	870	187570	318	188966	990	189789	744
176291	464	182179	548	187662	860	188973	990	189796	744
176352	429	183077	466	187686	138	188980	996	189802	744
176369	429	183336	999	187716	424	189000	996	189819	744
176536	339	183343	999	187846	924	189031	997	189826	744
176550	339	183794	997	187853	924	189062	997	189833	744
176598	220	185590	1005	187860	924	189093	998	189840	744
176611	220	186795	052	187877	924	189109	998	189857	744
176628	329	186801	052	187884	924	189147	990	189864	744
176642	220	186825	229	187891	924	189154	990	189871	744
176666	220	186832	064	187907	924	189161	990	189888	744
176680	220	186849	156	187914	924	189178	990	189895	744
176734	220	186856	156	187921	924	189185	990	189901	744
177199	360	186863	156	187976	752	189192	990	189918	744
177205	360	186887	216	187983	752	189505	744	189925	744
177212	360	186894	216	187990	752	189529	744	189932	744
178776	276	186900	262	188003	752	189536	744	189949	744
178783	276	186948	906	188010	752	189543	744	189956	744
178790	276	186955	906	188027	752	189574	744	189963	744
179254	598	186962	906	188058	752	189581	744	189970	744
179292	838	186979	906	188065	752	189598	744	189987	744
179308	838	186986	798	188072	752	189604	744	189994	744
179315	838	186993	798	188089	752	189611	744	190006	744
179322	838	187006	410	188096	752	189628	744	190013	744
179612	229	187013	1003	188102	752	189635	744	190020	744
179643	645	187075	936	188119	752	189642	744	190037	744
179667	645	187082	936	188126	752	189659	744	190044	744
179681	318	187327	919	188133	752	189666	744	190051	744
179766	172	187341	955	188140	752	189673	744	190068	744
179858	264	187358	955	188157	752	189680	744	190075	744

# Indice per codice

		191997	726	192659	726	194172	860	196787	126
		192277	782	192666	726	194189	860	196794	126
190082	744	192284	782	192673	726	194196	860	196800	126
190099	744	192291	782	192680	726	194202	860	196961	050
190105	744	192307	782	192697	726	194257	752	196978	050
190181	744	192314	782	192703	726	194295	436	196985	050
190259	744	192321	782	192710	726	194301	752	196992	050
190778	048	192338	782	192727	726	194417	391	197036	382
190808	048	192345	782	192734	726	194424	391	197050	069
190815	048	192352	782	192741	726	194448	391	197302	400
191164	726	192369	782	192758	726	194677	450	197319	400
191171	726	192376	782	193090	298	194684	450	197326	400
191188	726	192383	782	193106	298	194806	138	197333	400
191263	726	192390	782	193137	298	195285	069	197487	607
191355	726	192406	782	193359	788	195476	872	197500	607
191362	726	192413	782	193366	788	195483	872	197524	607
191379	726	192420	726	193373	788	195490	872	197654	090
191416	726	192437	726	193380	788	195506	872	197661	090
191423	726	192444	726	193397	788	195704	834	197708	560
191430	726	192451	726	193403	788	195711	834	197715	560
191447	726	192468	726	193410	788	195728	834	197722	560
191454	726	192475	726	193427	788	195735	834	197739	560
191461	726	192482	726	193434	788	195742	834	197746	560
191478	726	192499	726	193441	788	195759	834	197753	560
191485	726	192505	726	193458	788	195766	834	197791	503
191492	726	192512	726	193465	788	195773	834	197920	415
191508	726	192529	726	193472	788	195872	427	197944	415
191577	876	192536	726	193489	788	196190	284	198071	420
191584	876	192543	726	193502	788	196206	284	198095	198
191591	726	192550	726	193519	788	196220	284	198125	430
191607	876	192567	726	193526	788	196640	275	198132	430
191614	874	192574	726	193533	788	196657	275	198149	430
191621	874	192581	726	193540	788	196688	340	198156	430
191638	874	192598	726	193557	788	196695	340	198620	900
191645	726	192604	726	194110	788	196701	340	198637	900
191652	726	192611	726	194127	788	196718	340	198644	900
191669	726	192628	726	194134	788	196725	303	198668	726
191973	726	192635	726	194141	788	196732	303	198675	726
191980	726	192642	726	194158	788	196770	126	198682	726

198699	726	200231	818	201368	409	205144	837	206394	054
198705	726	200248	818	201382	692	205151	837	206622	538
198712	726	200255	818	201399	692	205168	837	206639	538
199023	726	200316	836	202396	782	205175	837	206646	538
199030	726	200330	658	202921	967	205182	837	206790	448
199375	478	200347	658	202945	967	205281	435	206806	449
199382	478	200354	658	203041	260	205298	435	206820	449
199399	478	200361	658	203072	758	205304	435	206844	449
199405	478	200477	082	203089	758	205311	435	206875	449
199412	478	200484	082	203102	758	205786	820	207155	520
199429	478	200491	082	203119	758	205793	820	207162	520
199528	673	200583	198	203126	758	205809	820	207186	520
199535	673	200590	198	203133	808	205816	820	207193	520
199795	078	200606	198	203140	808	205823	864	207216	520
199801	078	200880	436	203157	1001	205830	864	207476	492
199870	320	200897	436	203171	331	205847	864	207483	492
199894	320	200903	436	203188	331	205854	864	207490	492
199917	320	200910	297	203195	331	205861	830	207582	370
199931	320	200927	297	203232	1002	205878	830	207636	572
199962	260	200934	297	203249	1002	205892	830	207650	572
199986	540	200965	520	203256	1002	205908	830	207766	378
199993	540	200996	520	203263	1002	205939	880	207780	378
200002	540	201016	520	203270	1002	205946	880	207834	404
200019	540	201023	520	204451	990	205977	810	207841	404
200026	540	201054	234	204468	990	205984	810	207858	404
200033	540	201078	234	204475	990	205991	810	207988	420
200057	540	201085	234	204505	990	206004	810	207995	420
200064	540	201092	234	204536	990	206011	810	208046	194
200071	540	201115	234	204543	990	206028	810	208053	194
200088	540	201122	234	204581	758	206035	810	208152	552
200095	540	201139	833	204598	758	206042	810	208169	202
200101	540	201153	833	204611	758	206141	768	208176	202
200118	402	201160	863	204628	758	206196	768	208183	202
200125	402	201177	863	204635	758	206202	768	208282	630
200132	402	201252	990	204888	372	206219	768	208299	630
200149	402	201269	990	204895	372	206226	768	208398	414
200194	818	201276	990	204949	372	206233	768	208497	552
200200	818	201283	990	204956	372	206240	768	208503	552
200217	818	201290	990	205137	837	206387	054	208541	774



# Indice per codice

		211718	861	213583	542	218861	788	221885	975
		211749	861	213590	879	219721	788	221892	975
208558	774	211756	861	214009	872	219738	234	221908	945
208565	774	211763	774	214474	208	219875	234	221915	945
208572	774	211770	774	214481	208	220604	230	221922	945
208589	774	211787	774	214498	208	220611	434	221939	945
208596	774	211794	774	214504	208	220628	434	221946	900
208602	774	211800	774	214511	208	220635	617	221953	900
208626	774	211817	774	214672	849	220642	617	222097	900
208640	774	211824	774	214689	849	220659	617	222103	854
208657	774	211831	774	214696	849	220772	617	222110	854
208664	774	211848	774	215440	736	220789	788	222257	854
208671	774	211855	774	215693	279	220796	788	222509	996
208688	774	211862	774	215709	279	220802	788	222523	738
208695	774	211879	774	215747	299	220826	788	222530	738
208701	774	211886	774	215761	299	220963	726	222547	738
208718	774	211893	774	215778	299	221199	382	222554	738
208725	774	212623	984	215785	299	221205	224	222561	738
208732	774	212647	984	215891	726	221342	224	222578	738
208749	774	212760	921	215907	726	221359	260	222585	738
208794	408	213194	876	215969	520	221373	260	222592	738
208817	408	213200	876	216027	774	221489	480	222608	738
209036	996	213217	964	216263	774	221496	450	222615	738
209043	996	213231	955	216270	726	221502	450	222622	738
209845	902	213255	955	216287	726	221519	902	222639	738
209852	902	213262	918	216294	726	221595	902	222646	738
209906	902	213279	918	216300	726	221649	1000	222653	738
209913	902	213309	874	216317	774	221656	774	222660	738
211381	854	213316	874	216324	774	221663	774	222677	738
211398	854	213347	954	216416	726	221670	774	222684	738
211404	854	213354	954	216423	726	221687	774	222691	738
211459	861	213378	939	216430	726	221694	774	222707	738
211466	861	213385	939	216447	726	221816	774	222714	738
211541	518	213484	480	217253	752	221823	975	222745	738
211558	518	213491	543	218724	782	221830	975	222752	700
211565	518	213507	543	218823	890	221847	975	222769	700
211572	518	213521	543	218830	788	221854	975	222776	700
211596	518	213545	542	218847	788	221861	975	222783	736
211701	861	213569	542	218854	788	221878	975	222790	736

222813	736	223209	814	224152	714
222820	736	223216	814	224169	714
222837	984	223223	814	224176	714
222844	984	223230	814	224183	714
222851	979	223254	814	224190	714
222868	979	223285	856	224213	714
222875	979	223292	700	224237	714
222882	979	223704	700	224244	714
222899	700	223711	758	224251	714
222905	700	223728	758	224268	714
222912	700	223735	758	224275	714
222929	700	223742	758	224282	714
222936	700	223759	758	224367	714
222943	700	223766	758	224718	997
222950	700	223773	758	224725	714
222967	700	223780	736	224732	714
222974	700	223797	736	224756	714
222981	700	223803	736	224763	714
222998	700	223834	736	226187	714
223001	700	223889	990	226194	979
223018	700	223896	861	226200	979
223025	700	223902	861	226217	979
223032	700	223919	861	226712	979
223049	700	223926	990	226729	856
223056	700	223933	990	226736	856
223063	700	223940	990	226743	856
223070	700	223964	990	226750	856
223087	700	223988	990	227580	856
223094	700	223995	714	227597	752
223100	700	224022	714	227634	752
223117	700	224053	714	227672	788
223124	700	224060	714	227689	752
223131	700	224084	714	216829	752
223148	700	224091	714		
223155	700	224107	714		
223162	700	224114	714		
223179	700	224121	714		
223186	700	224138	714		
223193	814	224145	714		



## Contatti

**IDEAL LUX s.r.l.**  
Via Taglio Destro, 32  
30035 Mirano (Venezia)  
P.I. / C.F. 02420040277

**IDEAL LUX Warehouse**  
Via delle Industrie, 8/D  
30036 Santa Maria di Sala (Venezia)  
8.00 - 12.00 / 13.30 - 17.00

**IDEAL LUX Web**  
[www.ideal-lux.com](http://www.ideal-lux.com)  
[info@ideal-lux.com](mailto:info@ideal-lux.com)

**IDEAL LUX Office**  
Tel. +39 041 5790500  
Fax +39 041 8872349  
8.00 - 12.00 / 13.30 - 17.30

## Note

Ideal Lux s.r.l. si riserva il diritto di apportare, in qualunque momento e senza preavviso, tutte le modifiche necessarie a migliorare la qualità degli articoli illustrati nel presente catalogo.

Tutti i nostri prodotti si alimentano con tensione nominale di 240V e sono conformi alle direttive CE.

I valori riferiti ai Lumen relativi alle lampade con sorgenti integrate a LED, sono da considerarsi NOMINALI, riferiti cioè alla sorgente. Per i Lumen effettivi dei singoli apparecchi illuminanti si prega gentilmente di consultare le fotometrie. Per ulteriori delucidazioni e aggiornamenti si prega di contattare l'ufficio tecnico.

Community Design Pending Nr. 001996372 002022038 002194993 002621862 002943449 003734342 004558609 006083655

Copyright 2019 © IDEAL LUX S.r.l. – All rights reserved – Tutti i diritti sono riservati





**ideal lux**<sup>®</sup>  
[www.ideal-lux.com](http://www.ideal-lux.com)

**IDEAL LUX s.r.l.**  
Via Taglio Destro, 32  
30035 Mirano (Venezia)  
8.00 - 12.00 / 13.30 - 17.30

**IDEAL LUX Warehouse**  
Via delle Industrie, 8/D  
30036 Santa Maria di Sala (Venezia)  
8.00 - 12.00 / 13.30 - 17.00